

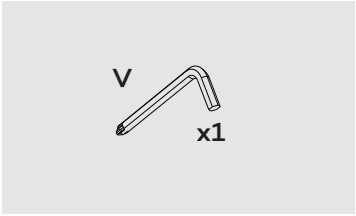

Takara Shelf (Wide) + Cabinet

These are the parts included in the box.

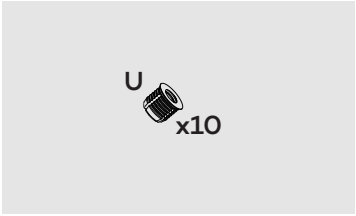
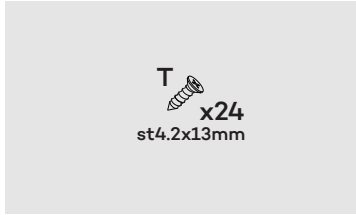
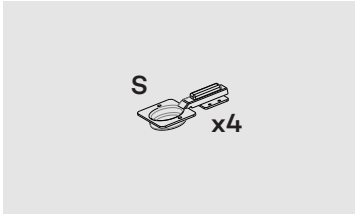
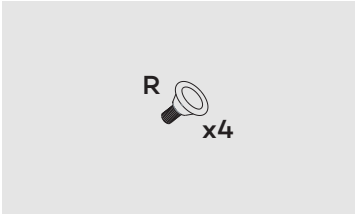
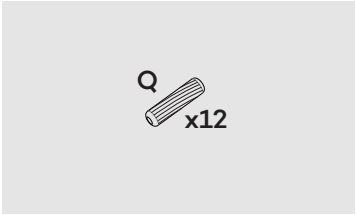
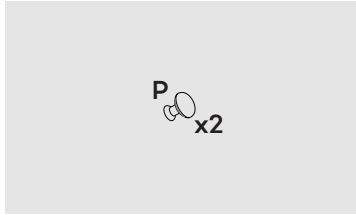
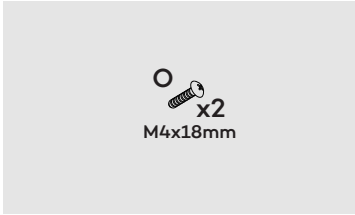
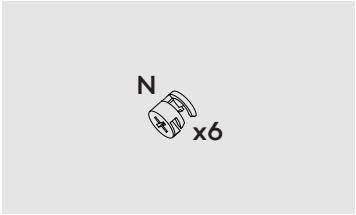
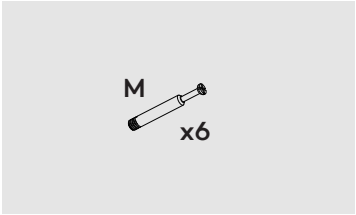
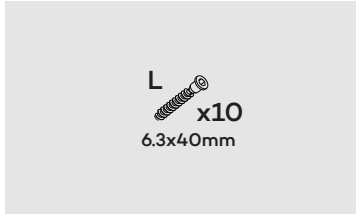
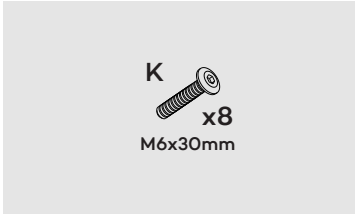
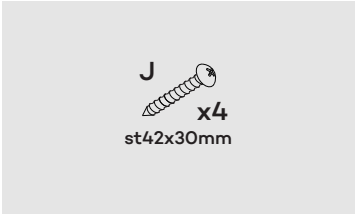
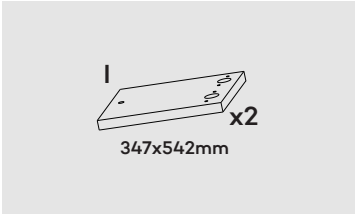
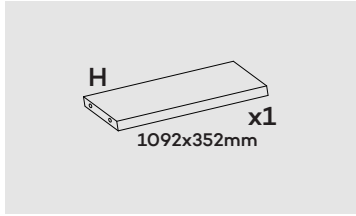
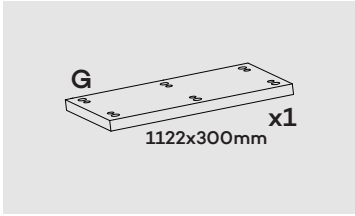
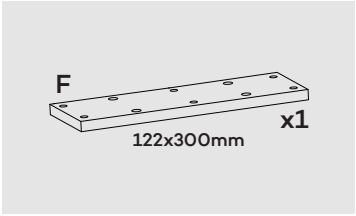
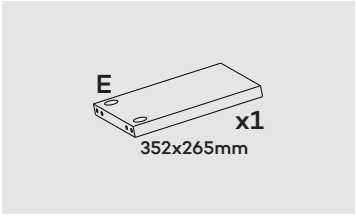
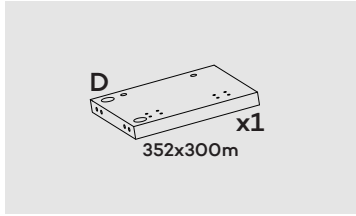
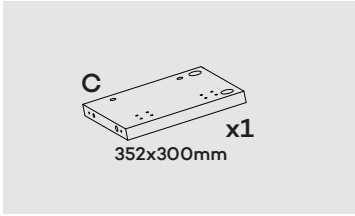
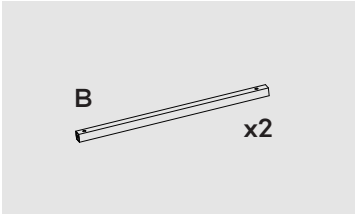
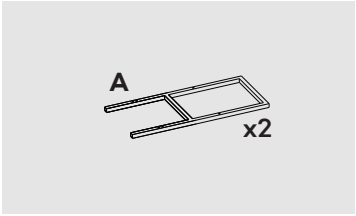
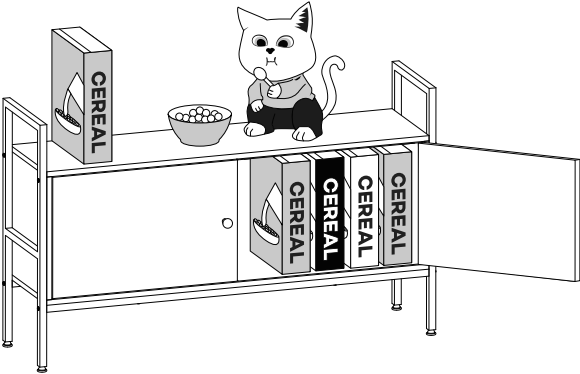

Put It Together in 3 Easy Stages!

STAGE 1 OF 3

Shelf Legs & Cabinet Doors

PARTS NEEDED

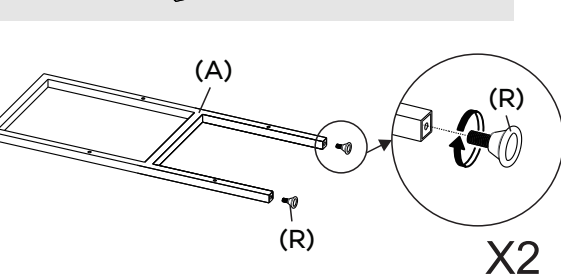

STEP 1.1

Screw-in the (R) levelling feet into the bottom of the (A) shelf legs as illustrated.

PARTS NEEDED

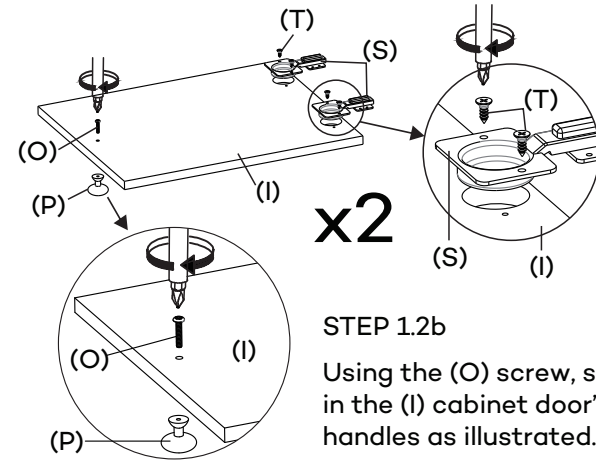
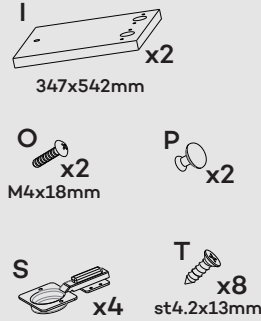

STEP 1.2a

Using the (T) screws, screw in the (S) hinges to the (I) cabinet door.

x2

STEP 1.2b

Using the (O) screw, screw in the (I) cabinet door's (P) handles as illustrated.



STAGE 2 OF 3

The Cabinet!

PARTS NEEDED



STEP 2.1a

Insert the (Q) wooden dowels into their holes in the (G) panel.

STEP 2.1b

Insert the (U) anchor and screw in the (M) cam dowel through it on their holes in the (G) panel.

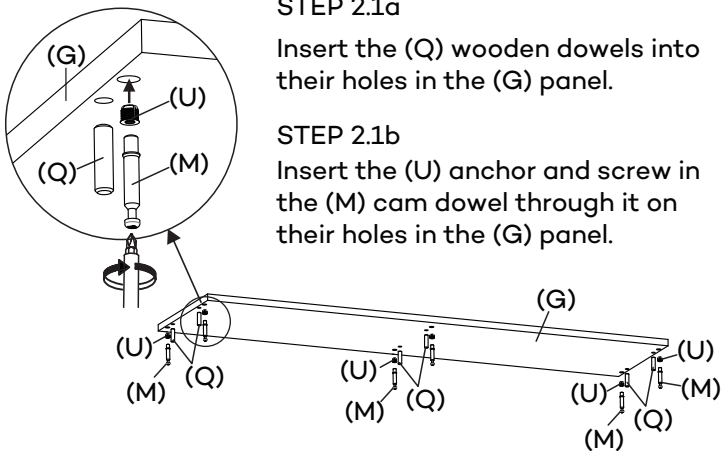

PARTS NEEDED

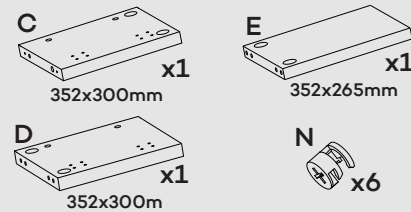

STEP 2.2

Using the (N) cam locks, lock the (M) cam dowels with the (C), (D), and (E) panels as illustrated.

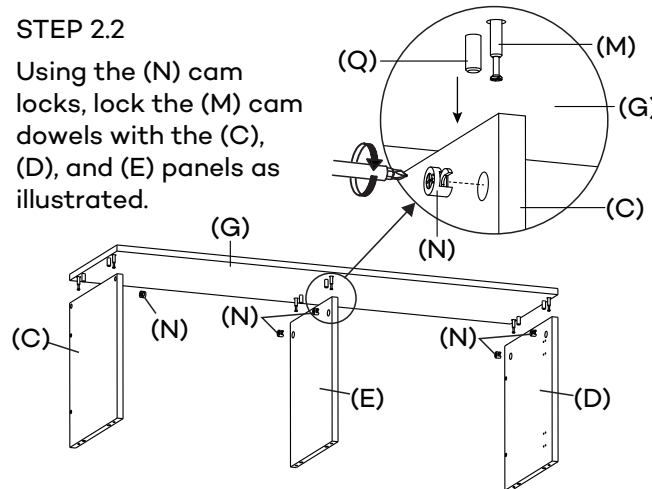

PARTS NEEDED

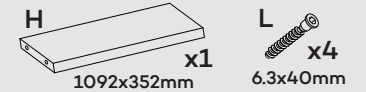

STEP 2.3

Using the (L) screw, screw in the (H) back panel into the sides of the (C) and (D) panels as illustrated.

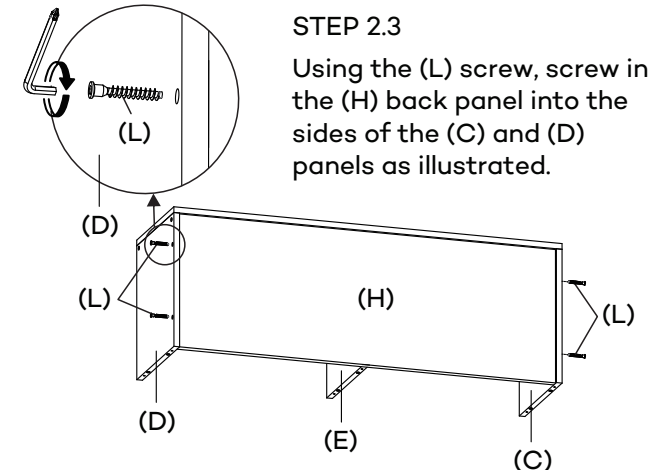

Turn the furniture to its back to follow this illustration.

PARTS NEEDED U x4 Q x6

STEP 2.4a
Push in the (U) anchors into the sides of the (C) and (D) panels as illustrated.

STEP 2.4b
Insert the (Q) wooden dowels into their holes in the (C), (D), and (E) panels.

PARTS NEEDED F 122x300mm x1 L 6.3x40mm x6

STEP 2.5
Use the (L) screws to screw-in the (F) panel into the bottom of the (C), (D), and (E) panels as illustrated.

i Turn the furniture to its front to follow this illustration.

PARTS NEEDED B x2 J st42x30mm x4

STEP 2.6
Use the (J) screws to the screw-in the (B) supporting bars into the (F) panel as illustrated.

STAGE 02

i Turn the furniture to its back to follow this illustration.

FINAL STAGE
Put it all together!

PARTS NEEDED K x8 M6x30mm

STEP 3.1
Use the (K) screws to screw-in the (A) shelf legs into the sides (B) supporting bars, and of the (C) and (D) panels as illustrated.

PARTS NEEDED T x16 st4.2x13mm

STEP 3.3
Use the (T) screws to screw-in the (S) hinges into the (C) and (D) panels as illustrated.

STEP 3.3
Make sure all the screws are tight enough and...

DONE!

STAGE 03