

WALLACE

FLYNN™

COLLECTIVE

SOFA SLEEPER UNIT REPLACEMENT INSTRUCTIONS



WET BAN

336-781-0504

SALES@SLEEPERMECHANISM.COM

SLEEPERMECHANISM.COM

SLEEPER 
MECHANISM
.com

REMOVING THE OLD SLEEPER UNIT



1.

Unfold the sleeper unit to bed position.

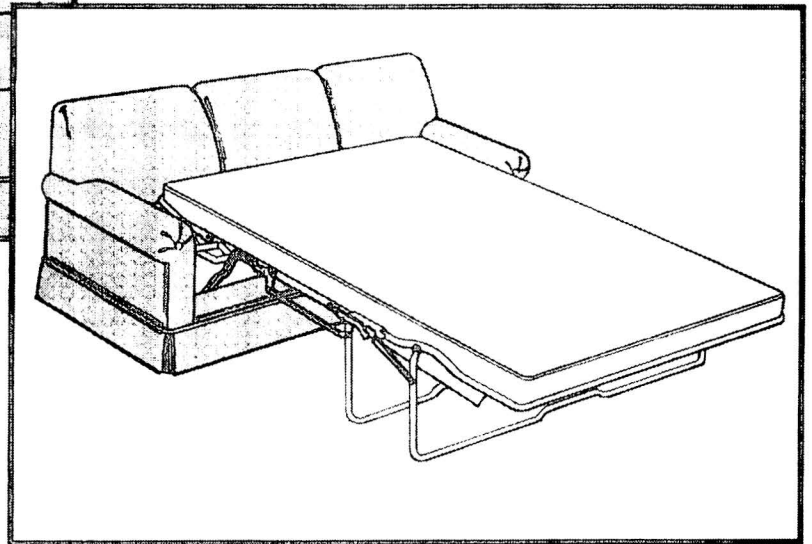

Unit in full open bed position.

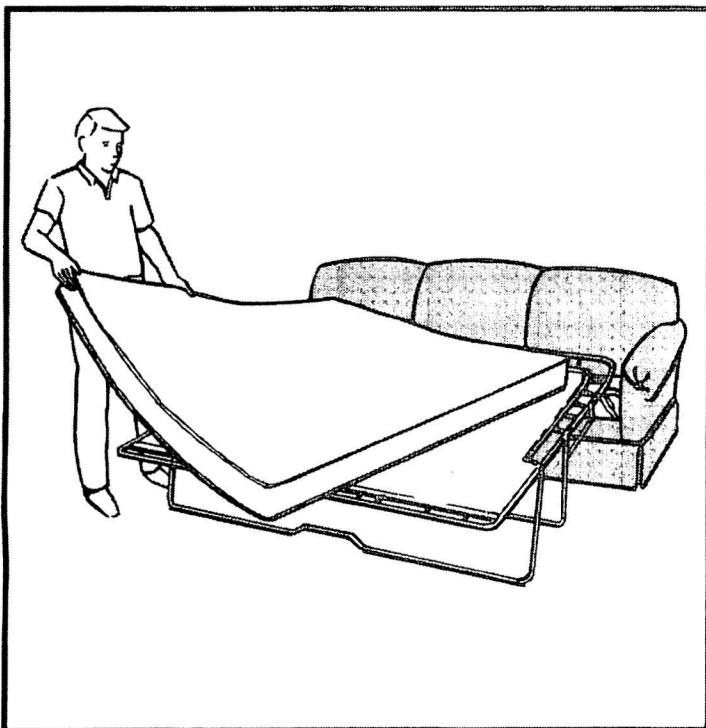

2.

Remove mattress from sleeper unit.

3.

Raise T.V. headrest to the up position. This allows access to the mounting plate where screws must be loosened or removed.

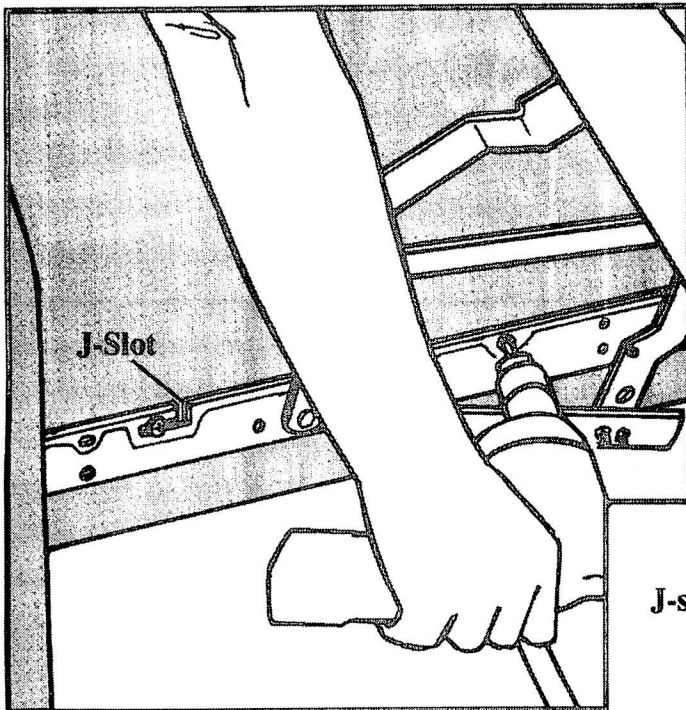
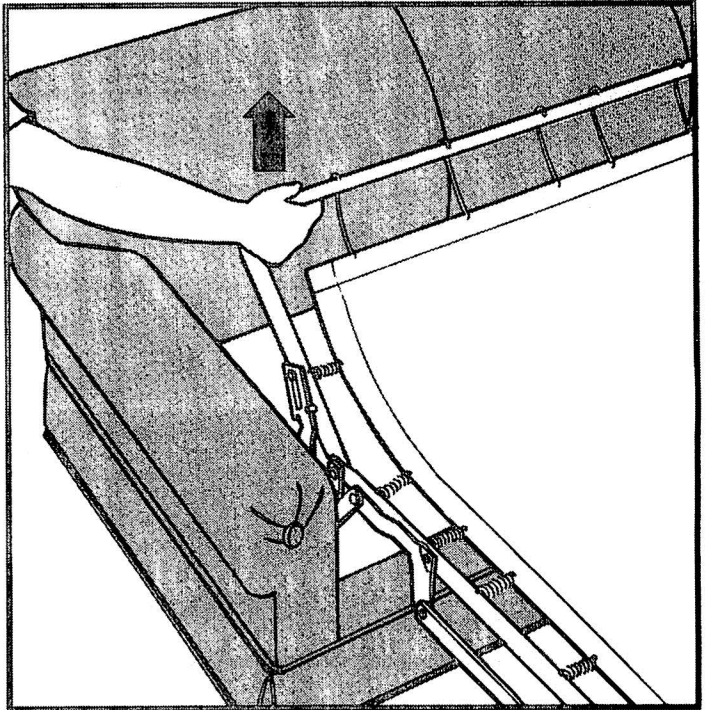

4. Remove all screws from the mounting plate, except for the TWO J-SLOT screws that should only be loosened, but not removed. Repeat procedure on opposite side.

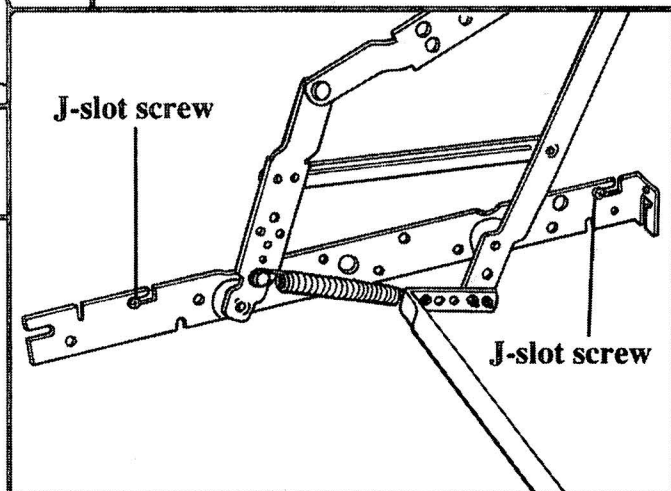

Note: Only loosen the two J-slot screws to allow for accurate positioning of new sleeper unit.

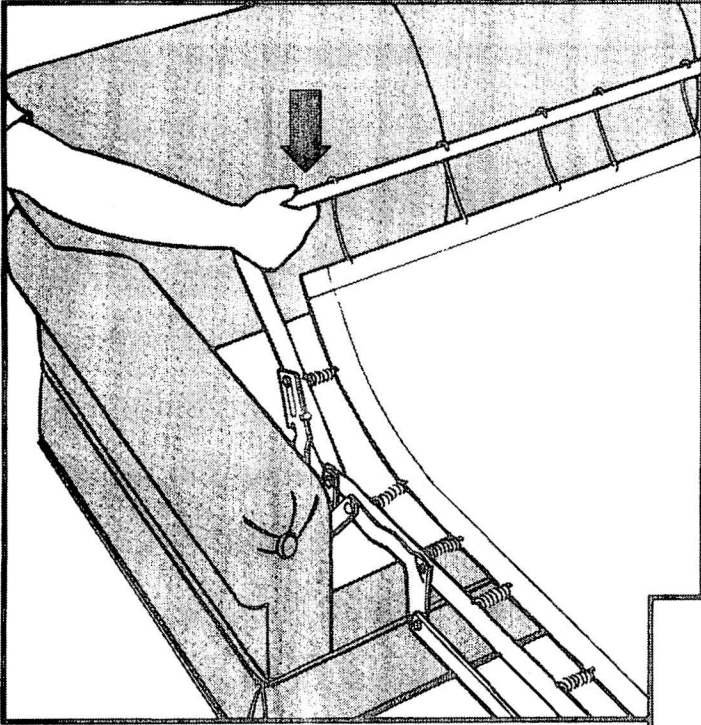

5.

Lower T.V. headrest. Refold unit into sofa slowly without mattress. Unit may fall off of J-slot screws while folding into sofa.

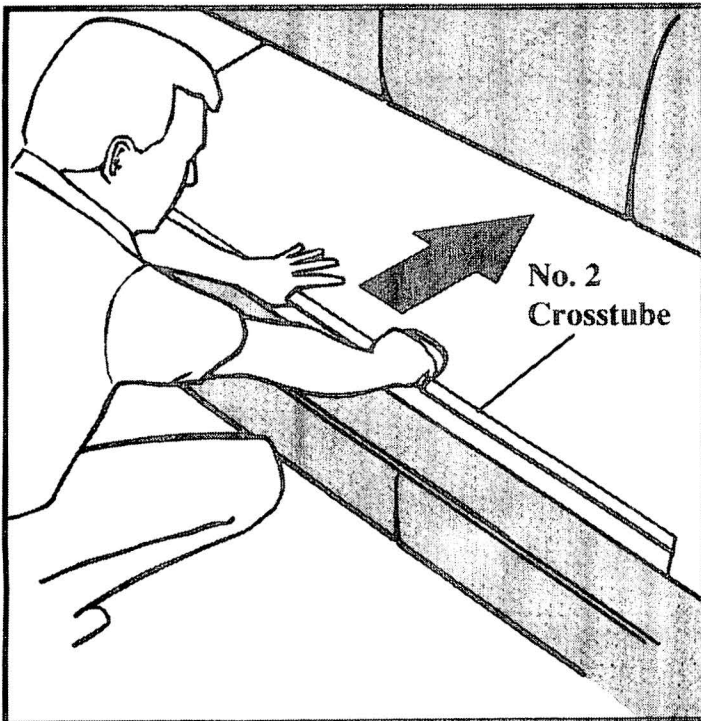
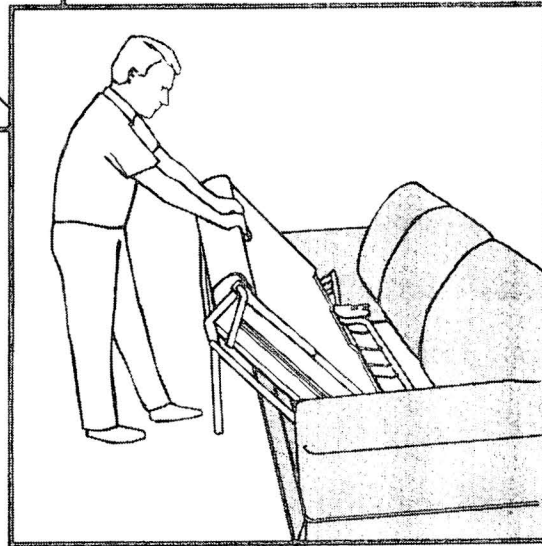

If sleeper unit does not come off the J-slot screws during closing, grasp No. 2 Crosstube shown in illustration and push toward back of sofa. (You may need to go to each end and lift unit off.)

6.

Tilt sofa up from the back side and lay sofa completely over on its front side. Sleeper unit should now be laying on the floor behind sofa.

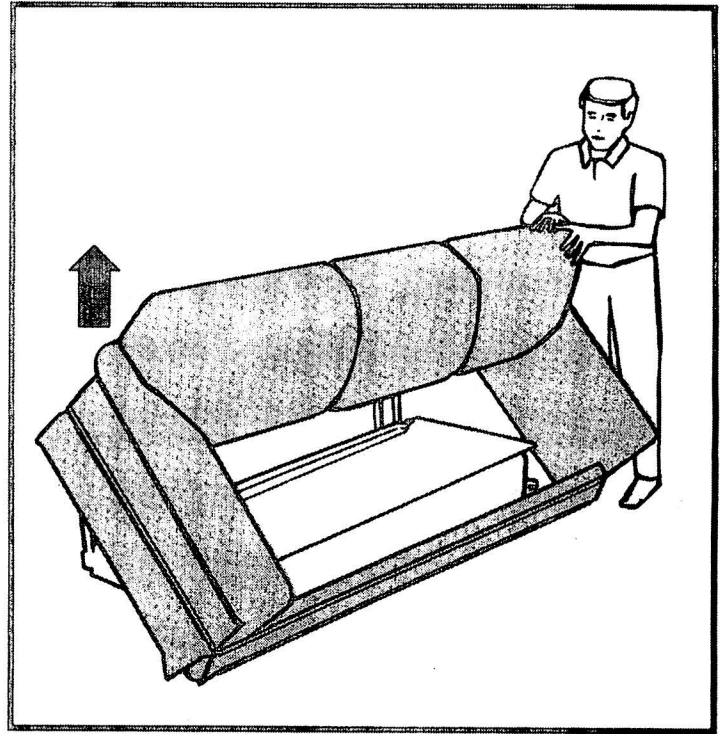

7.

Place new sleeper unit on its back and remove tie wires from the new unit. (Caution should be taken since the pilot tube and mounting plate may fall down while unit is on its back.) Tilt sleeper unit up on back side (as shown in illustration) and place wires around legs and side braces on each end of the old sleeper unit.

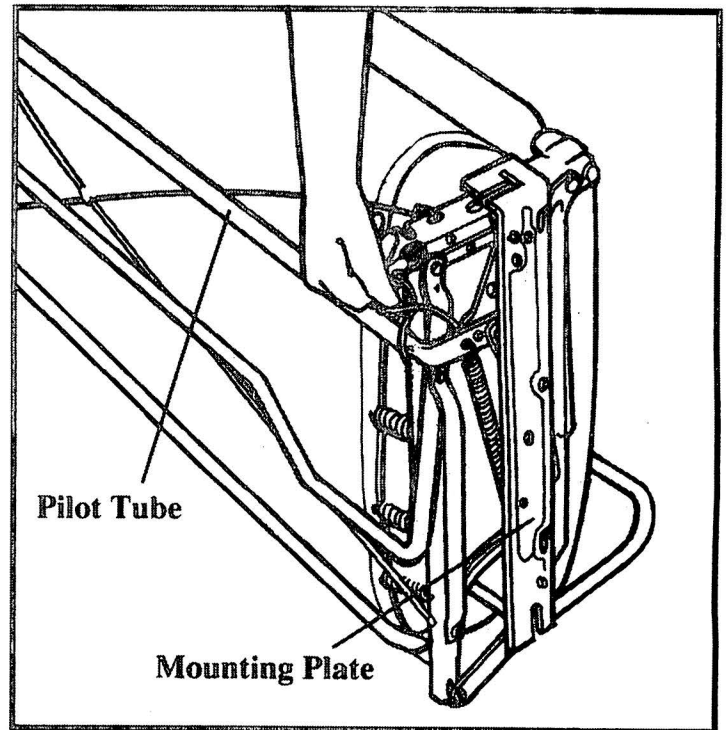

INSTALLATION OF NEW SLEEPER UNIT

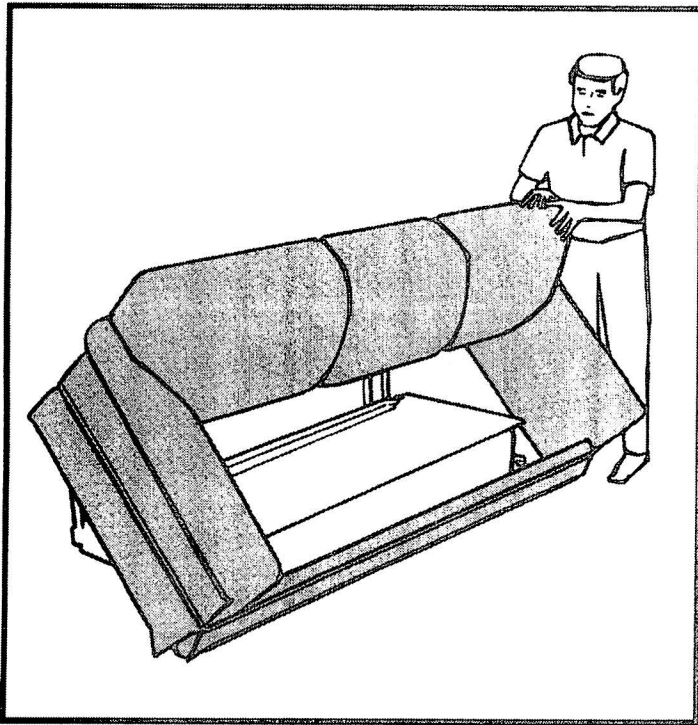

8.

Place new unit in same position as old unit and lower sofa down over new sleeper mechanism.



9.

Unfold sleeper mechanism slowly (because unit is not yet secured to a sofa frame) from the sofa to the full open position.

10.

Lift up sleeper at one end, at pilot arm, and upper rear support and slide J-slot screws into J-slots, which are in side rails. Push the unit forward (toward front rail). Tighten J-slot screws and install screws which were removed in Step 3. Repeat at opposite end of sofa.

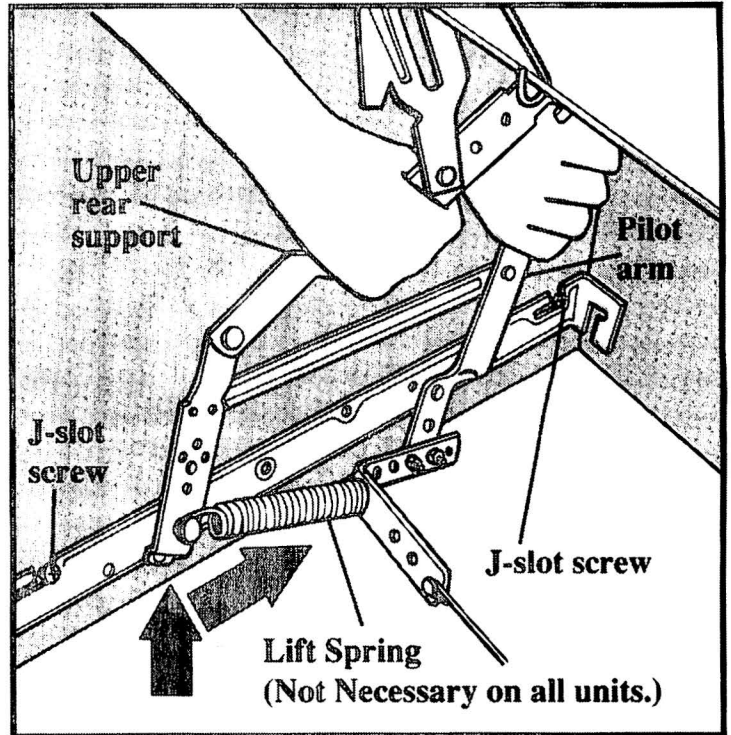

(CAUTION: Watch for pinch points and sharp edges when grasping mechanism.)

11.

Replace mattress.
Fold sleeper into sofa.
Replacement is now complete.

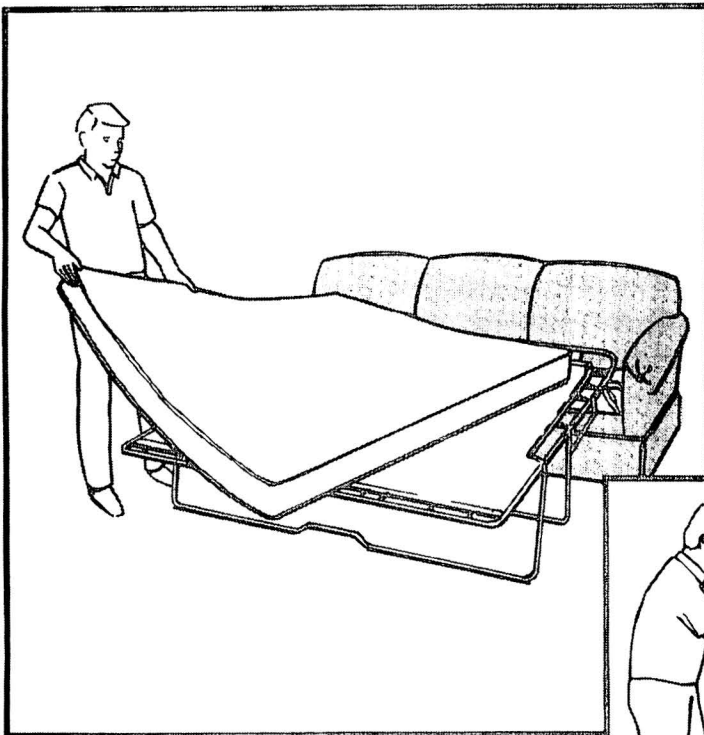



Anti-microbial protection that inhibits the growth of stain and odor-causing bacteria to ensure your fabric stays cleaner and fresher for longer.



DURABLE



EASILY CLEANED



ANTI-MICROBIAL



WATER RESISTANT



STAIN RESISTANT

For more information or to view our Wet Ban™ Ultra Smart Mattress line, please contact us.

wetban.com

336-781-0504

sales@wallaceflynn.com