

# Instructions for Use of Functional Test Kit on Digitrip 520 and 1150 Family of IEC Rated Low Voltage Power (Air) Circuit Breakers

---

## **⚠ WARNING**

DO NOT ATTEMPT TO INSTALL OR PERFORM MAINTENANCE ON EQUIPMENT WHILE IT IS ENERGIZED. DEATH OR SEVERE PERSONAL INJURY CAN RESULT FROM CONTACT WITH ENERGIZED EQUIPMENT. ALWAYS VERIFY THAT NO VOLTAGE IS PRESENT BEFORE PROCEEDING. ALWAYS FOLLOW SAFETY PROCEDURES. EATON IS NOT LIABLE FOR THE MISAPPLICATION OR MISINSTALLATION OF ITS PRODUCTS.

---

---

## **⚠ WARNING**

OBSERVE ALL RECOMMENDATIONS, NOTES, CAUTIONS, AND WARNINGS RELATING TO THE SAFETY OF PERSONNEL AND EQUIPMENT. OBSERVE AND COMPLY WITH ALL GENERAL AND LOCAL HEALTH AND SAFETY LAWS, CODES, AND PROCEDURES.

---

---

## **⚠ CAUTION**

TESTING A CIRCUIT BREAKER WHILE IN-SERVICE AND CARRYING LOAD CURRENT IS NOT RECOMMENDED FOR POWER AND MEDIUM VOLTAGE CIRCUIT BREAKERS. TESTING THAT RESULTS IN THE TRIPPING OF THE CIRCUIT BREAKER SHOULD BE DONE ONLY WITH THE CIRCUIT BREAKER IN A DEENERGIZED SYSTEM OR IN THE TEST OR DISCONNECTED CELL POSITIONS OR WHILE IT IS ON A TEST BENCH. PERFORMING TESTS WITHOUT THE EATON-APPROVED TEST KIT MAY DAMAGE THE TRIP UNIT.

---



# EATON

*Powering Business Worldwide*

| <b>Contents</b>                | <b>Page</b> |
|--------------------------------|-------------|
| <b>Section 1: Introduction</b> |             |
| General .....                  | 3           |
| When to test .....             | 3           |
| Batteries .....                | 3           |

|  |   |
|--|---|
| <b>Section 2: Series NRX Circuit Breakers with Digitrip 520 or 1150 Trip Unit Test Procedure</b> |   |
| Setup .....  | 5 |
| Power Up .....   | 6 |
| Instantaneous Trip Testing .....   | 6 |
| Short Delay Trip Testing .....   | 6 |
| Long Delay Pickup and Trip Testing .....   | 6 |
| Ground (Earth) Fault Trip Testing (if applicable) .....  | 6 |
| After Testing Completion .....   | 7 |

|  |   |
|--|---|
| <b>Section 3: Magnum Circuit Breakers with Digitrip 520 Trip Unit Test Procedure</b> |   |
| Set Up .....   | 7 |
| Power Up .....   | 8 |
| Instantaneous Trip Testing .....   | 8 |
| Maintenance Mode (ARMS) Trip Testing (if applicable) ..                              | 8 |
| Short Delay Trip Testing .....   | 8 |
| Long Delay Pickup and Trip Testing .....   | 9 |
| Ground (Earth) Fault Trip Testing (if applicable) .....                              | 9 |
| After Testing Completion .....   | 9 |

|   |    |
|---|----|
| <b>Section 4: Magnum Circuit Breakers with Digitrip 1150 Trip Unit Test Procedure</b> |    |
| Setup .....   | 10 |
| Power Up .....  | 10 |
| Instantaneous Trip Testing .....  | 10 |
| Maintenance Mode (ARMS) Trip Testing (if applicable) ..                               | 10 |
| Short Delay Trip Testing .....  | 11 |
| Long Delay Pickup and Trip Testing .....  | 11 |
| Ground (Earth) Fault Trip Testing (if applicable) .....                               | 11 |
| After Testing Completion .....  | 11 |

| <b>List of Figures</b>   | <b>Page</b> |
|--|-------------|
| Figure 1. Typical Test Kit .....   | 3           |
| Figure 2. Nameplate Digitrip 520/1150 Family<br>(Series NRX) .....                 | 4           |
| Figure 3. Nameplate Digitrip 520 Family (Magnum) ...                               | 4           |
| Figure 4. Nameplate Digitrip 1150 Family (Magnum) ...                              | 5           |
| Figure 5. Test Kit and Series NRX Trip Unit Shown ...                              | 5           |
| Figure 6. Long Time Memory (LTM) Jumper .....                                      | 6           |
| Figure 7. Long Time Memory (LTM) Jumper .....                                      | 7           |
| Figure 8. Test Kit and Magnum Trip Unit<br>Shown Connected .....                   | 7           |
| Figure 9. Breaker Secondary Contact Jumper for<br>Ground Fault Test (Magnum) ..... | 9           |

## Section 1: Introduction

### General

The Functional Test Kit shown in **Figure 1** is a handheld battery powered tester capable of testing electronic trip elements for many of Eaton's power circuit breaker trip units. This includes Digitrip Trip Unit models 520, 520M and 1150i utilized in IEC rated Series NRX (IZMX) circuit breakers, and models 520i, 520Mi, 520MCi and 1150i utilized in IEC rated Magnum (IZM) circuit breakers. A test kit is capable of testing a variety of trip unit models by simply overlaying the appropriate nameplate on the tester (**Figures 2, 3 and 4**).

When using this test kit, a functional local test of the trip unit's primary electronic circuitry and the circuit breaker's mechanical tripping action can be verified through the trip unit's test port receptacle. The types of tests that can be done are trip unit Power Up, Long Time Trip, Instantaneous Trip, Short Delay Trip, and Ground (Earth) Fault Trip. These test selections are chosen via the switch labeled "Select Test" on the test kit.

An Auxiliary Power Module is included to provide trip unit power to illuminate trip units that have displays.

It is recommended to use the auxiliary power module when testing to get confirmation of the cause of trip and the value of the test current.

### When to test

Series NRX and Magnum power (air) circuit breakers can be tested prior to start-up or with the circuit breaker out of its cassette. They can also be tested while in the TEST, DISCONNECTED, WITHDRAWN, or REMOVED cassette positions.

**Note:** Since time-current settings are based on desired system coordination and protection schemes, the protection settings selected and preset should be reset to their as-found conditions if altered during any routine test sequence. If there are any questions or further assistance is needed, please contact your local Eaton representative or visit [www.eaton.com](http://www.eaton.com).

---

### **⚠ CAUTION**

---

**TESTING A CIRCUIT BREAKER WHILE IN SERVICE AND CARRYING LOAD CURRENT IS NOT RECOMMENDED FOR POWER CIRCUIT BREAKERS. TESTING THAT RESULTS IN TRIPPING OF THE CIRCUIT BREAKER SHOULD BE DONE ONLY WITH THE CIRCUIT BREAKER IN A DEENERGIZED SYSTEM OR IN THE TEST DISCONNECTED CASSETTE POSITIONS, OR WHILE IT IS ON A TEST BENCH. PERFORMING TESTS WITHOUT THE EATON APPROVED TEST KIT COULD DAMAGE THE DIGITRIP TRIP UNIT.**

---

### Batteries

The Functional Test Kit contains a total of seven 9-Volt batteries located under the back cover. Remove the four screws securing the back cover in place to access the batteries. A single Lithium ion cell is the preferred battery type for BAT A and is attached to the main pc board of the Test Kit. This battery has a much longer life span to accurately perform the selected tests. The remaining six batteries, BAT B, are located on a separate board in the test kit and serve to power up the trip unit.

LED's A and B function to represent sufficient battery voltage. If either LED does not light or lights only dimly, replace the appropriate battery or batteries. To do this, open the back of the case using a screwdriver and remove the battery or batteries from their respective locations

For best results, replace Lithium battery (Battery A) with ULTRALIFE® U9VL Battery.

When replacing battery six-pack (BAT B), replace all batteries at the same time using standard 9V alkaline batteries.



Figure 1. Typical Test Kit



**Functional Test Kit  
For Series NRX with  
Digitrip 520, 520M, 1150, 1150i**

**70C1056**

**Push to Test**

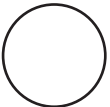

**Battery Voltage**

A B



**Select Test**

POWER UP

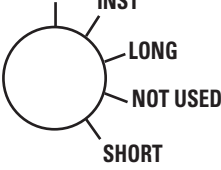

INST  
LONG  
NOT USED  
SHORT

**Test Procedures: (brief instruction, for details check Ref I.L.5721B13)**

- Connect cable from Test Kit to Circuit Breaker
  - Note the Circuit Breaker settings at this time.
  - Make the following Circuit Breaker settings.  
Long PU = 0.6, Long Time = 2, Short PU = 2, Inst = 2, GROUND = .25.
- Power Up and Test Settings:**
  - Position switch on test cable to "Phase".
  - Push Test Button, LEDs, A, B light, Status LED flashes. Unit should not trip.
  - Release Test Button.
- Instantaneous Trip:**
  - Position Select Test to INST.
  - Inst LED should flash.
  - Push Test and release immediately after trip
  - Reset breaker and trip unit.
- Short Delay Trip:**
  - Position Select Test to SHORT
  - Short Time LED should flash
  - Push Test and release immediately after trip.
  - Reset breaker and trip unit.
- Long Delay Pickup and Trip:**
  - Set Short Pickup and INST to 10x.
  - Position Select Test to LONG.
  - Push Test and hold.
  - Status LED flashes at fast rate.
  - Long Delay Trip in 3 to 35 seconds  
release test button.
  - Long Delay Trip LED should flash.
  - Reset breaker and trip unit.
- Ground Fault Trip: (if applicable).**
  - Position switch on cable to Ground
  - Push Test and release immediately after trip.
  - Trip and/or Ground Fault LED flashes.
  - Reset breaker and trip unit.
- Return Digitrip settings to original condition**

NP5720B54H4

Figure 2. Nameplate Digitrip 520/1150 Family (Series NRX)



**Functional Test Kit  
For Magnum with Digitrip  
220, 520, 520i,  
520M, 520Mi, 520MCi  
For VCP-T/T-VAC with Digitrip  
520V, 520MCV**

**70C1056**

**Push to Test**

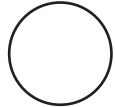

**Battery Voltage**

A B



**Select Test**

POWER UP

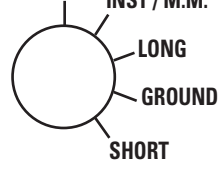

INST / M.M.  
LONG  
GROUND  
SHORT

**Test Procedures: (brief instruction, for details check Ref I.L.5721B13).**

- Note the Digitrip settings at this time.
  - Adjust LTM jumper to horizontal position (See I.L.)
  - Connect cable from Test Kit to Digitrip.
- Test Settings:**
  - Set Long Delay @ .4x.
  - Set Long Time @ 2s.
  - Set Short Delay @ 4.
  - Set Inst @ 2.
- Power Up:**
  - Push Test button, LEDs A, B light, Status LED flashes, Unit should not trip.
  - Release Test button.
- Instantaneous Trip:**
  - Position Select Test to INST /M.M.
  - Push Test and release.
  - Inst - Trip LED should flash if so equipped
  - Reset breaker and trip unit.
- Short Delay Trip: (if applicable).**
  - Push Test and release after trip.
  - Short time LED flash.
  - Reset breaker and trip unit.
- Long Delay Pickup and Trip.**
  - Position Select Test to LONG
  - Push Test and Hold
  - Status LED flashes at fast rate.
  - Long Delay Trip in 5 to 8 seconds. Release Test button immediately after trip.
  - Long Delay Trip LED should flash.
  - Reset breaker and trip unit.
- Ground Fault Trip: (if applicable).**
  - Attach jumper B-6 to B-7 (see IL).
  - Position Select Test to GROUND.
  - Push Test and release immediately after trip.
  - Trip and/or Ground Fault LED flashes
  - Reset breaker and trip unit.
- Maintenance Mode Trip: (ARMs) (if applicable)**
  - Set Digitrip Inst to OFF.
  - Set Maintenance Mode to ON (Indicated by blue LED).  
Set to RS.
  - Position Select Test to INST/M.M.
  - Push Test and release.
  - M.M. trips with Inst LED Flashing.
- Return Digitrip settings to original condition**

NP5720B54H4

Figure 3. Nameplate Digitrip 520 Family (Magnum)

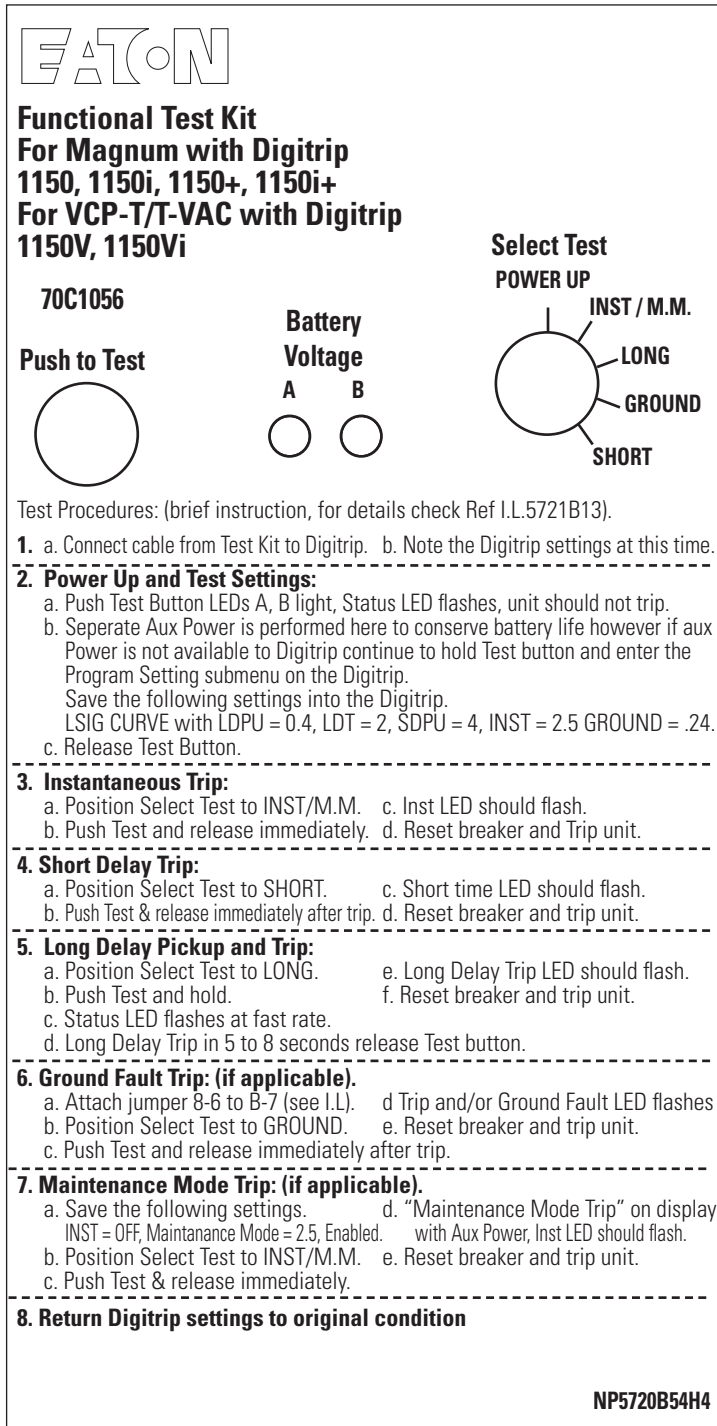

Figure 4. Nameplate Digitrip 1150 Family (Magnum)

## Section 2: Series NRX Circuit Breakers with Digitrip 520 or 1150 Trip Unit Test Procedure

### Setup

**Note:** Before testing, record all trip unit settings in use so they can be accurately restored upon completion of the test.

A plexiglass cover covering the trip unit must be removed to access the trip unit's test port. Simply remove the three screws holding the plexiglass cover in place. Once removed, a small additional cover covering the test port can be simply removed by pulling the tether on the cover.

### CAUTION

**THE ZONE SELECTIVE INTERLOCKING (ZSI) FUNCTION IS AN OPTIONAL FEATURE THAT CAN BE ORDERED FROM THE FACTORY. WITHOUT THIS FEATURE, THE TRIP UNIT WILL ALWAYS FOLLOW THE PROGRAMMED SHORT TIME DELAY OR GROUND FAULT TIME DELAY SETTINGS. WHEN TESTING A CIRCUIT BREAKER THAT IS EQUIPPED WITH THE ZONE SELECTIVE INTERLOCKING FEATURE, A JUMPER MAY BE REQUIRED BETWEEN SECONDARY TERMINALS 27 AND 29 TO PROVIDE SELF INTERLOCKING SO THAT TIME DELAY SETTINGS MAY BE OBSERVED WHEN TESTING SHORT OR GROUND PROTECTION.**

Connect the Functional Test Kit Cable from the left side of the Functional Test Kit to the Test Port Pins located on the front of the Digitrip Trip Unit (**Figure 5**). The trip unit end of the test kit cable is designed in such a way that it will only fit in the test port correctly.

Use the following settings to begin testing:

- Long Pickup = 0.6x
- Long Time = 2
- Instantaneous = 2x
- Ground (Earth) = 0.25

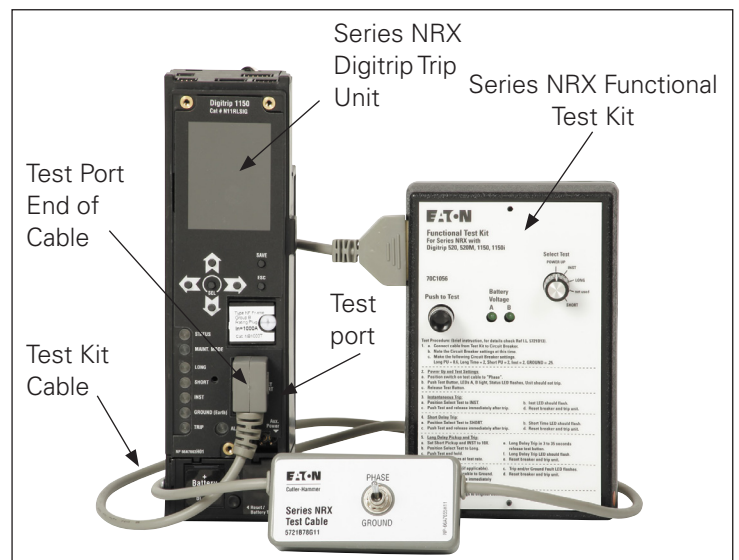

Figure 5. Test Kit and Series NRX Trip Unit Shown

**Power Up**

Put the Long Time Thermal Memory function in the Inactive mode when testing the NRX 520 styles (**Figure 6**). **After the testing, remember to return the jumper to the state it was in before the testing.** For NRX 1150, the LTM function can be enabled or disabled as a setting. The setting is located in the PGM Set (Program Settings) submenu, and then in the Trip/Alarm settings, under the Current Trip settings.

Set the Select Test Switch on the Test Kit to the "POWER UP" position. Position the switch located on the test cable to "PHASE".

Push the Test Button and observe:

- LEDs A and B on the Test Kit should light indicating available battery voltages
- Status LED on Digitrip Trip Unit should flash
- A trip should not occur
- Release the Test button

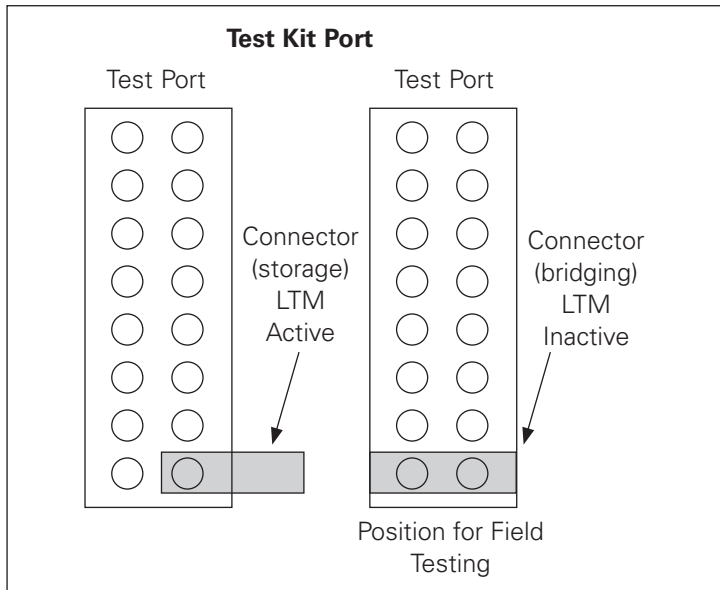

**Figure 6. Long Time Memory (LTM) Jumper**

**Instantaneous Trip Testing**

Proceed as following:

- Set Select Test Switch to "INST" position
- Push and hold Test Pushbutton for maximum of one (1) second – release immediately after circuit breaker trips or Digitrip Trip Unit indicates a trip condition
- Instantaneous LED should flash
- Reset circuit breaker and Digitrip Trip Unit

**Short Delay Trip Testing**

Proceed as follows:

- Set Select Test Switch to "SHORT" position
- Set Instantaneous Pickup to 10x
- Push and hold Test pushbutton for maximum of one (1) second – release immediately after circuit breaker trips or Digitrip Trip Unit indicates a trip condition
- Short Time LED should flash
- Reset circuit breaker and Digitrip trip unit

**Long Delay Pickup and Trip Testing**

Proceed as follows:

- Set Short Delay Pickup and Instantaneous to 10x
- Set Select Test Switch to "LONG" position
- Push and hold Test pushbutton
- Status indicator LED on trip unit should flash rapidly
- Long Delay Trip is 3 to 35 seconds
- Long Delay Trip LED should flash
- Release immediately after circuit breaker trips or Digitrip trip unit indicates a trip condition
- Reset circuit breaker and Digitrip trip unit

**Note:** After a circuit breaker trip has occurred, release the "Push to Test" pushbutton immediately. If it is held too long after a trip, the Digitrip Trip Unit will reenter its protection algorithm to start timing out for a second trip. In this process, the previous expected trip LED indication may get cleared.

**Ground (Earth) Fault Trip Testing (if applicable)**

Test the ground (earth) fault protection system to verify compliance with applicable IEC requirements.

Proceed as follows:

- Set switch on test kit cable to "GROUND"
- Push and hold Test pushbutton for maximum of one (1) second or release immediately after circuit breaker trips or Digitrip trip unit indicates a trip condition
- Trip and/or Ground (Earth) Fault LED flashes
- Reset circuit breaker and Digitrip trip unit

**After Testing Completion**

Proceed as follows:

- Always disconnect the Test Kit Cable from the Test Kit to prevent operation and/or battery drainage and reinstall test port cover
- Reset all Digitrip Trip Unit settings to original condition
- Reinstall previously removed plexiglass cover over Digitrip Trip Unit
- Restore any temporary connections made during testing to proper operating conditions before returning circuit breaker to service
- Record all test results on test form provided with equipment
- Test Kit components should be stored together in case

**Section 3: Magnum Circuit Breakers with Digitrip 520 Trip Unit Test Procedure**

**Setup**

**Note:** Before testing, record all trip unit settings in use so they can be accurately restored upon completion of the test.

Remove the plexiglass cover from the circuit breaker covering the Digitrip trip unit. This is accomplished by removing two screws holding the plexiglass cover in place. Once removed, a small additional cover covering the test port can be simply removed by pulling the tether on the cover.

If necessary, reposition the Thermal Memory jumper temporarily to a “bridging” position in order to defeat memory for these tests (Figure 7).

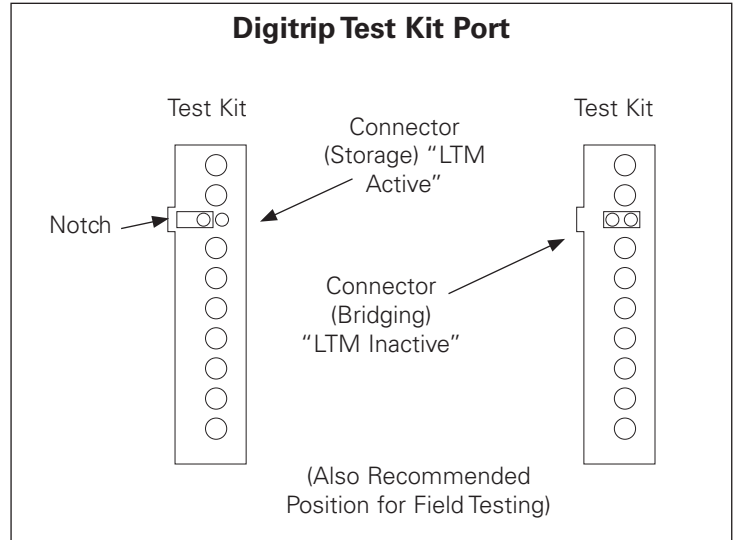

**Figure 7. Long Time Memory (LTM) Jumper**

Connect the Functional Test Kit cable from left side of Functional Test Kit to Test Port pins located on the left side of the Digitrip Trip Unit (Figure 8). The trip unit end of the Test Kit cable is designed in such a way that it will only fit over Test Port pins correctly.

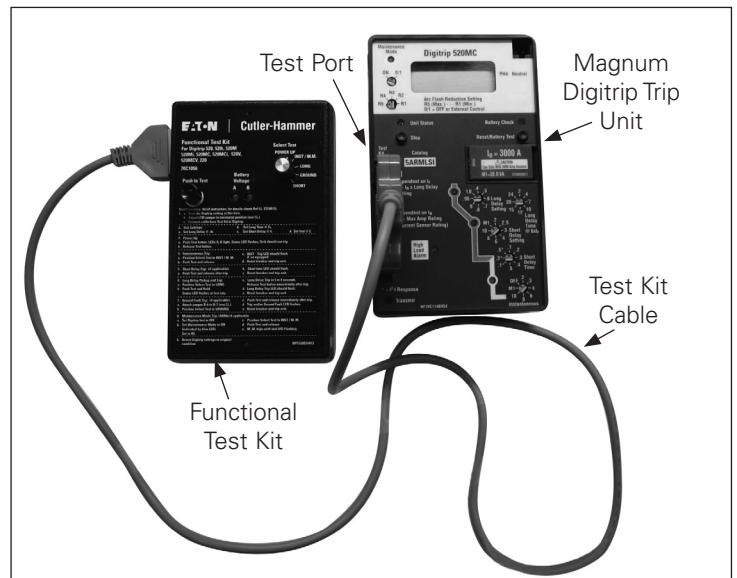

**Figure 8. Test Kit and Magnum Digitrip Trip Unit Shown Connected**

**CAUTION**

**BEFORE PLUGGING A TEST KIT INTO THE TEST PORT, VERIFY THAT THE LTM JUMPER IS IN THE INACTIVE POSITION (FIGURE 6). AFTER TESTING, RETURN THE LTM JUMPER TO ITS ORIGINAL POSITION. THIS IS NECESSARY TO ENSURE A SUCCESSFUL TESTING PROCEDURE.**

**CAUTION**

**THE ZONE SELECTIVE INTERLOCKING (ZSI) FUNCTION IS AN OPTIONAL FEATURE THAT CAN BE ORDERED FROM THE FACTORY. WITHOUT THIS FEATURE, THE TRIP UNIT WILL ALWAYS FOLLOW THE PROGRAMMED SHORT TIME DELAY OR GROUND FAULT TIME DELAY SETTINGS. WHEN TESTING A CIRCUIT BREAKER THAT IS EQUIPPED WITH THE ZONE SELECTIVE INTERLOCKING FEATURE, A JUMPER MAY BE REQUIRED BETWEEN SECONDARY TERMINALS B8 AND B9 TO PROVIDE SELF INTERLOCKING SO THAT TIME DELAY SETTINGS MAY BE OBSERVED WHEN TESTING SHORT OR GROUND PROTECTION.**

### Power Up

Set the Select Test Switch on the Test Kit to the "POWER UP" position.

Push the Test Button and observe:

- LEDs A and B on the Test Kit should light indicating available battery voltages

**Note:** The cable has an interlock feature and must be connected to the tester to enable battery power.

- Status LED on Digitrip Trip Unit should flash at rate of approximately one second on and one second off
- A trip should not occur
- Release the Test button

On Digitrip 520Mi and 520MCi trip unit models, a current value can be observed by pressing the Step button to select the Phase 2 readout. The readout value should be approximately 30% of the Plug rating (In).

### Instantaneous Trip Testing

Proceed as following:

- Set Select Test Switch to "INST" position
- Set Digitrip trip unit's Instantaneous Pickup to 2x and Short Delay Setting to 10x
- Close circuit breaker
- Push Test Pushbutton – release immediately after circuit breaker trips or Digitrip trip unit indicates a trip condition
- Instantaneous LED should flash at 4 or 5 second repetition rate
- Reclose circuit breaker and reset trip unit by depressing Reset Pushbutton

### Maintenance Mode (ARMS) Trip Testing (if applicable)

This fast acting analog trip function can be verified as follows:

- Set Select Test Switch to "INST/MM" position
- Set Digitrip Trip Unit's Instantaneous Pickup to OFF, Short Delay Setting to M1, and Long Delay Setting to 1.0x
- Set Maintenance Mode to ON setting
- Apply auxiliary power to receptacle in upper right corner of trip unit
- Blue LED will light indicating Maintenance Mode active
- Set Maintenance Mode reduction setting to R5 (maximum reduction-lowest pickup setting)
- Push Test pushbutton – release immediately
- Circuit breaker should trip
- Instantaneous LED should flash at a 4 or 5 second repetition rate
- Reposition Maintenance Mode to 0/1 to do other testing
- Reclose circuit breaker and reset trip unit by depressing Reset pushbutton

### Short Delay Trip Testing

Proceed as follows:

- Set Select Test switch to "SHORT" position
- Set Instantaneous Pickup to 6x or higher and Short Delay Pickup to 2x
- Push Test pushbutton and release immediately after circuit breaker trips or Digitrip Trip Unit indicates a trip condition
- Short Time LED should flash
- Reset circuit breaker and Digitrip trip unit
- Reposition Short Delay Pickup setting to 4x or higher



# Instructions for Use of Functional Test Kit on Digitrip 520 and 1150 Family of IEC Rated Low Voltage Power (Air) Circuit Breakers

## Long Delay Pickup and Trip Testing

Proceed as follows:

- Set Select Test Switch to “LONG” position
- Set Short Delay Pickup to 4x or higher
- Set Long Delay Pickup to 0.4x and Long Delay Time to 2 seconds
- Push and hold Test pushbutton
- Status indicator LED on trip unit should flash rapidly, indicating an overload
- Long Delay Trip should occur in 5-8 seconds
- Long Delay Trip LED should flash
- Release immediately after circuit breaker trips or Digitrip trip unit indicates a trip condition
- Reset circuit breaker and Digitrip trip unit

**Note:** After a circuit breaker trip has occurred, release the “Push to Test” pushbutton immediately. If it is held too long after a trip, the Digitrip trip unit will reenter its protection algorithm to start timing out for a second trip. In this process, the previous expected trip LED indication may get cleared.

## Ground (Earth) Fault Trip Testing (if applicable)

Test the ground (earth) fault protection system to verify compliance with applicable IEC requirements.

Proceed as follows:

- Set switch on test kit cable to “GROUND”
- Plug in Ground (Earth) Fault test connector supplied with kit to circuit breaker’s “B” secondary contact block – this provides temporary jumper from terminals B-6 to B-7 of circuit breaker (**Figure 9**)

**Note:** The circuit breaker will have to be in its disconnected position to plug in this connector. The jumper connection could be accomplished by other means.

- No setting changes are required for this test.
- Push and hold the Test pushbutton until circuit breaker trips and/or the Digitrip Ground (Earth) Fault LED flashes

When testing is completed, remove the Ground (Earth) Fault connector jumper with the yellow tag and disconnect the cable from both the trip unit and test kit.

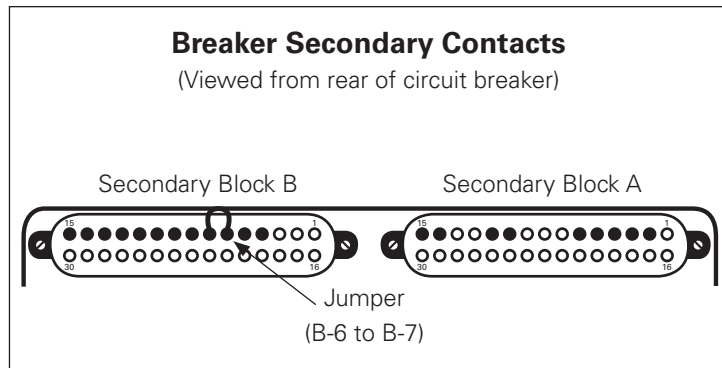

**Figure 9. Breaker Secondary Contact Jumper for Ground Fault Test (Magnum)**

**Note:** For Digitrip 520Mi and 520MCi Models: Before removing the test cable, set the Select Test Switch back to the “Power Up” position. Depress the “Push to Test” pushbutton and then depress the “Reset” pushbutton in the Digitrip Trip Unit. This action will provide a complete reset of the Digitrip’s cause of trip memory, and eliminate relighting of previous test trip LED when the circuit breaker is put back into service.

## After Testing Completion

Proceed as follows:

- Always disconnect test kit cable from test kit to prevent operation and/or battery drainage and reinstall port cover.
- Reset all Digitrip trip unit settings to original condition, including LTM jumper
- Reinstall previously removed test port cover and plexiglass cover over Digitrip Trip Unit
- Restore any temporary connections made during testing to proper operating conditions before returning circuit breaker to service
- Record all test results on test form provided with equipment
- Test Kit components should be stored together in case

**Note:** Refer to **Figure 7**. On the left side of the graphic, a relief notch is shown next to the jumper to accommodate a non-connected “storage” position. Some Digitrip Trip Units may not have this notch. In the case, the LTM is made active by placing the jumper over the outer pin and letting it hang down.

## Section 4: Magnum Circuit Breakers with Digitrip 1150 Trip Unit Test Procedure

### Setup

Before testing, apply the Digitrip 1150 overlay onto the handheld tester to aid in the test sequence (**Figure 4**).

Remove the plexiglass cover from the circuit breaker covering the Digitrip trip unit. This is accomplished by removing two screws holding the plexiglass cover in place. Once removed, a small additional cover covering the test port can be simply removed by pulling the tether on the cover.

**Note:** Before testing, record all trip unit settings in use so they can be accurately restored upon completion of the test. This can be accomplished by entering the **VIEW SET**tings menu.

### **⚠ CAUTION**

**IF ZONE INTERLOCKING IS NOT TO BE USED AND ONLY STANDARD TIME DELAY COORDINATION IS INTENDED, JUMPER TERMINAL B8 TO B9 ON THE CIRCUIT BREAKER SECONDARY CONNECTOR.**

Enter the Program Setting menu. Temporarily enter test settings by depressing the Reset pushbutton and selecting **PRO**gram **SET**tings in the middle display using the down arrow **VIEW** pushbutton.

Select **CURRENT** and then **LSIG** (curve). Make the following test settings:

- LONG SLOPE =  $I^2t$
- LONG Pickup = 0.4x
- LONG TIME = 2
- SHORT Pickup = 4x
- INSTANTANEOUS = 2.5x
- GROUND (EARTH) = 0.24x or 0.4x
- Push **SAVE** to transfer Test settings into memory
- **VOLTAGE** Settings (if applicable) must be **DISABLED** at this time while performing current injection type tests

Connect the Functional Test Kit cable from left side of Functional Test Kit to Test Port Pins located on the left side of the Digitrip trip unit (**Figure 8**). The trip unit end of the test kit cable is designed in such a way that it will only fit over Test Port Pins correctly.

### Power Up

Set the Select Test Switch on the test kit to the "POWER UP" position.

Push the Test button and observe:

- LEDs A and B on the test kit should light indicating available battery voltage from both power sources – In the event that either of the LEDs do not light, refer to the Note in this section under the heading Long Delay Pickup and Trip Testing for assistance

**Note:** The cable has an interlock feature and must be connected to the tester to enable battery power.

- Status LED on Digitrip trip unit should flash at a rate of approximately one second on and one second off
- A trip should not occur
- Release the Test button

### Instantaneous Trip Testing

Proceed as following:

- Set Select Test Switch to "INST" position
- Close circuit breaker
- Push Test pushbutton – release immediately after circuit breaker trips or Digitrip trip unit indicates a trip condition

**Note:** The cable has an interlock feature and must be connected to the tester to enable battery power. In the event that either of the LEDs do not light, refer to the Note in this section under the heading Long Delay Pickup and Trip Testing for assistance.

### Maintenance Mode (ARMS) Trip Testing (if applicable)

This fast acting analog trip function can be verified using the test kit. For the Digitrip 1150i version, use the following settings made to the LSIG curve:

- LSIG = 1
- SDPU = M1
- NST = OFF
- MAINTENANCE MODE = 2.5x
- Maintenance Mode ENABLED
- Maintenance Mode ENABLED message displayed on trip unit

# Instructions for Use of Functional Test Kit on Digitrip 520 and 1150 Family of IEC Rated Low Voltage Power (Air) Circuit Breakers

Once settings are made, proceed as follows:

- Set Select Test Switch to “INST/MM” position
- Push Test pushbutton – release immediately
- Circuit breaker should trip
- Instantaneous LED should flash at a 4 or 5 second repetition rate
- Reset trip unit by depressing Reset pushbutton
- Reinstall original settings

## Short Delay Trip Testing

Proceed as follows:

- Set Select Test switch to “SHORT” position
- Push Test pushbutton and hold for maximum of one second
- Release immediately after circuit breaker trips or Digitrip trip unit indicates a trip condition
- Short Time LED should flash
- Reset Digitrip trip unit and red trip flag on circuit breaker

## Long Delay Pickup and Trip Testing

Proceed as follows:

- Set Select Test switch to “LONG” position
- Push and hold Test pushbutton
- Status indicator LED on trip unit should flash rapidly indicating an overload condition.
- Long Delay trip should occur in 5-8 seconds
- Long Delay trip LED should flash
- Release immediately after circuit breaker trips or Digitrip trip unit indicates a trip condition

**Note:** After a circuit breaker trip has occurred, release the “Push to Test” pushbutton immediately. If it is held too long after a trip, the Digitrip trip unit will reenter its protection algorithm to start timing out for a second trip. In this process, the previous expected trip LED indication may get cleared and a “CHECK AUX SWITCH” alarm message may appear on the display. This message would be as expected if the Test pushbutton is held in too long.

## Ground (Earth) Fault Trip Testing (if applicable)

Test the ground (earth) fault protection system to verify compliance with applicable IEC requirements.

Proceed as follows:

- Set switch on Test Kit Cable to “GROUND”
- Plug in Ground (Earth) Fault Test Connector supplied with kit to circuit breaker’s “B” secondary contact block – this provides temporary jumper from terminals B-6 to B-7 of circuit breaker (**Figure 9**).

**Note:** The circuit breaker will have to be in its Disconnected position to plug in this connector. The jumper connection could be accomplished by other means.

- No setting changes are required for this test.
- Push and hold Test Pushbutton until circuit breaker trips and/or Digitrip Ground (Earth) Fault LED flashes

When testing is completed, remove the Ground (Earth) Fault Connector jumper with the yellow tag and disconnect the cable from both the trip unit and test kit.

## After Testing Completion

Proceed as follows:

- Always disconnect test kit cable from test kit to prevent operation and/or battery drainage and reinstall test port cover.
- Reset all Digitrip trip unit settings to original condition
- Reinstall previously removed and plexiglass cover over Digitrip trip unit
- Restore any temporary connections made during testing to proper operating conditions before returning circuit breaker to service
- Record all test results on test form provided with equipment
- Test kit components should be stored together in case

### Disclaimer of warranties and limitation of liability

The information, recommendations, descriptions, and safety notations in this document are based on Eaton Corporation's ("Eaton") experience and judgment, and may not cover all contingencies. If further information is required, an Eaton sales office should be consulted.

Sale of the product shown in this literature is subject to the terms and conditions outlined in appropriate Eaton selling policies or other contractual agreement between Eaton and the purchaser.

THERE ARE NO UNDERSTANDINGS, AGREEMENTS, WARRANTIES, EXPRESSED OR IMPLIED, INCLUDING WARRANTIES OF FITNESS FOR A PARTICULAR PURPOSE OR MERCHANTABILITY, OTHER THAN THOSE SPECIFICALLY SET OUT IN ANY EXISTING CONTRACT BETWEEN THE PARTIES. ANY SUCH CONTRACT STATES THE ENTIRE OBLIGATION OF EATON. THE CONTENTS OF THIS DOCUMENT SHALL NOT BECOME PART OF OR MODIFY ANY CONTRACT BETWEEN THE PARTIES.

In no event will Eaton be responsible to the purchaser or user in contract, in tort (including negligence), strict liability, or otherwise for any special, indirect, incidental, or consequential damage or loss whatsoever, including but not limited to damage or loss of use of equipment, plant or power system, cost of capital, loss of power, additional expenses in the use of existing power facilities, or claims against the purchaser or user by its customers resulting from the use of the information, recommendations, and descriptions contained herein.

The information contained in this manual is subject to change without notice.

**Eaton Corporation**  
Electrical Group  
1000 Cherrington Parkway  
Moon Township, PA 15108  
United States  
877-ETN-CARE (877-386-2273)  
Eaton.com

© 2011 Eaton Corporation  
All Rights Reserved  
Printed in USA  
Publication No. IL01301067EH01  
October 2011



PowerChain  
Management<sup>®</sup>

Power Chain Management is a registered  
Trademark of Eaton Corporation

All other Trademarks are property of their  
respective owners.