

D900.S-CR LED downlight

Datasheet



Product codes

Unit:	Series:	Colour temp.:	Beam angle (°):	Colour:
D900.S	CR	3K 4K 5K	25 40	B (Black) W (White)

Photometrics

Standard Products

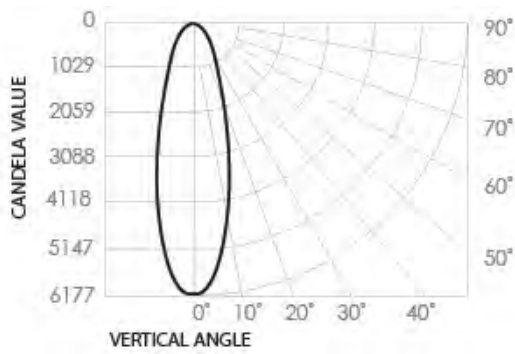

Source lumen output: 1165lm
 Delivered lumen: 920lm
 Efficacy: 77lm/W
 Colour temp.: 4000K
 Beam angle: 25°
 Standard Deviation of colour matching (SDCM): 0MacAdams Steps

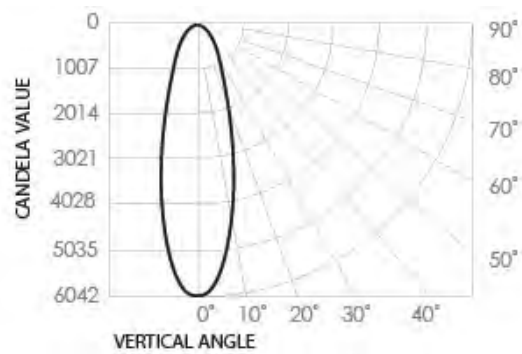

Source lumen output: 1140lm
 Delivered lumen: 900lm
 Efficacy: 75lm/W
 Colour temp.: 3000K
 Beam angle: 25°
 Standard Deviation of colour matching (SDCM): 0MacAdams Steps

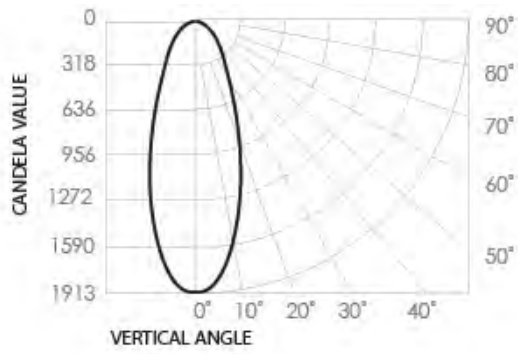

Source lumen output: 1140lm

Delivered lumen: 900lm

Efficacy: 75lm/W

Colour temp.: 3000K

Beam angle: 40°

Standard Deviation of colour matching (SDCM): 0MacAdams Steps

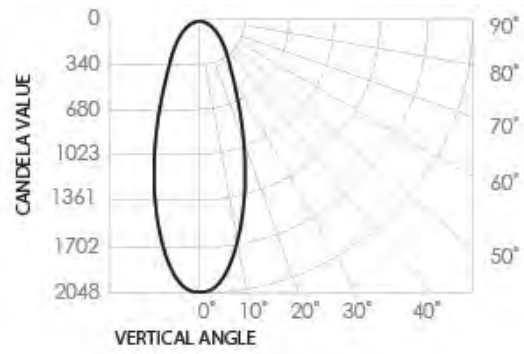

Source lumen output: 1165lm

Delivered lumen: 920lm

Efficacy: 77lm/W

Colour temp.: 4000K

Beam angle: 40°

Standard Deviation of colour matching (SDCM): 0MacAdams Steps

Dimensions (mm)

Front view

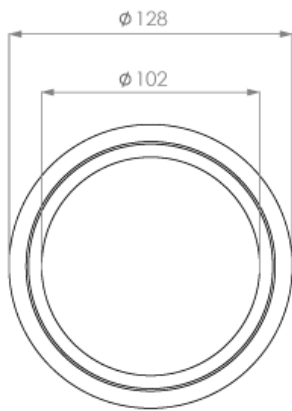

Side view

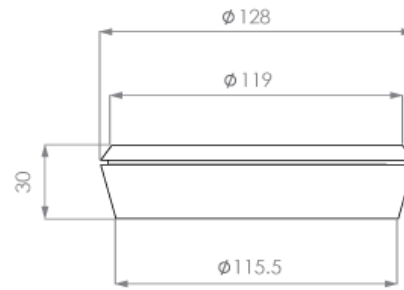

Electrical

Input voltage: 220-240V	Power usage: 12W	IP rating: IP44	Surge protection: Yes	Dimmable: No
-----------------------------------	----------------------------	---------------------------	---------------------------------	------------------------

Operational

Operating temp.: -10 to 90°C	Average temp.: 60°C	Ambient temp.: -28 to 65°C	Lifetime L70, B10: 70,000 hrs (@TA25)	Source Lumens: 1140lm or 1165lm
--	-------------------------------	--------------------------------------	---	---

Physical

Weight: 300g	Warranty: 7 years
------------------------	-----------------------------

Installation

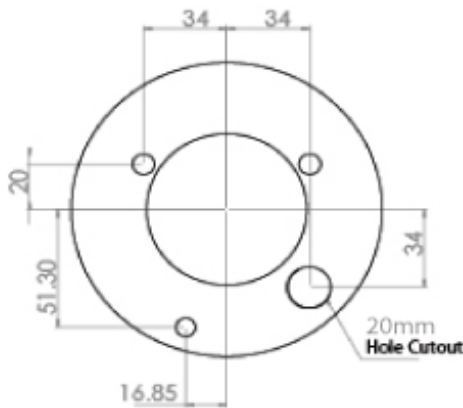

Step 1
Using a guide or the junction plate, mark out the placements of the 3 mounting screws and 20mm hole cut out.

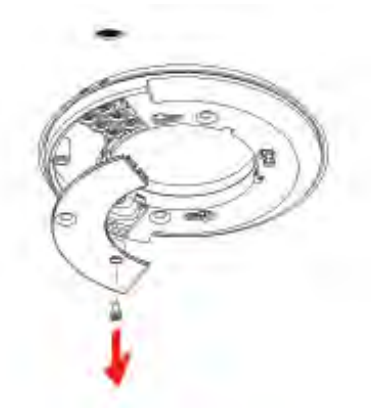

Step 2
Remove the cover on the junction plate by unscrewing the holding screw



Step 3
Pull the power cable through the junction plate.



Step 4
Strip back the outer insulation on the power cable line to allow approximately 8cm of the inner insulation wire. Correctly wire the power cable into the junction plate in line with Australian Standards. Where necessary daisy chain another power cable into the next unit.

Installation

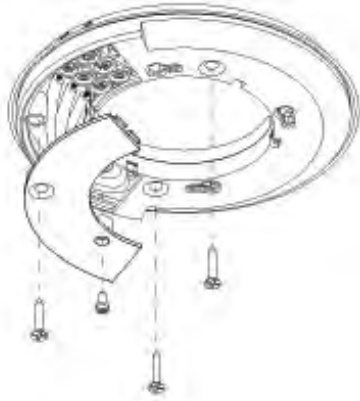

Step 5

Ensure cabling sits flat within the junction recess, then attach the junction cap and fasten the base plate to the ceiling using the provided screws.

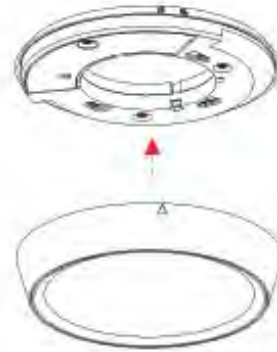

Step 6

Align the luminaire to the base plate.

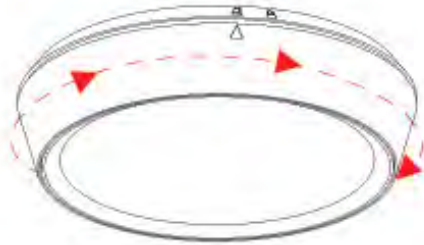

Step 7

Twist the luminaire clockwise to lock into position.