

Massachusetts Division of Fisheries and Wildlife

The Use of Water Flow Devices in Addressing Flooding Problems Caused by Beaver in Massachusetts

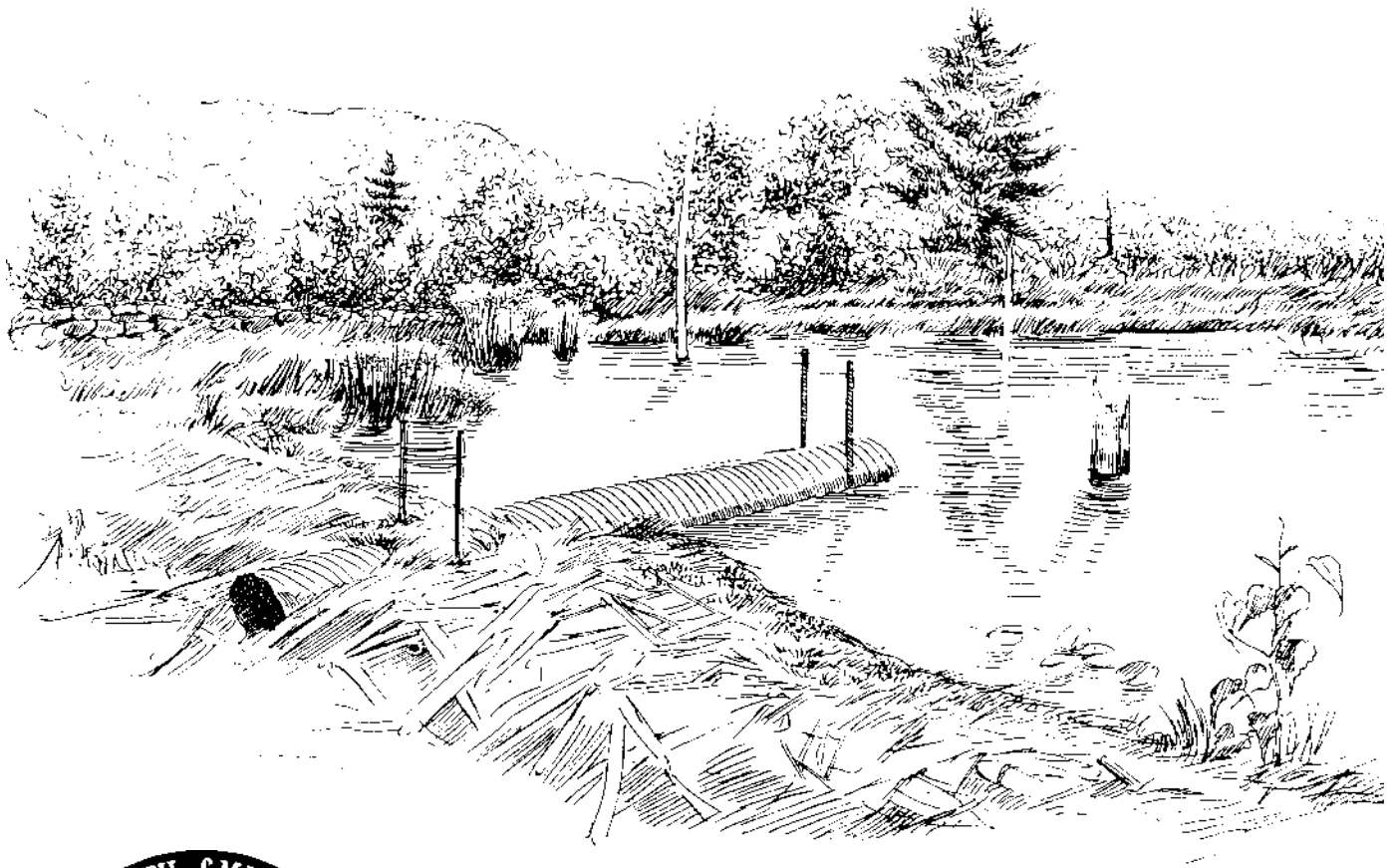

MassWildlife

The Use of Water Flow Devices in Addressing Flooding Problems Caused by Beaver in Massachusetts

Compiled by
Susan Langlois and Thomas Decker, 1997
Revised by Chrissie Henner, 2004
Massachusetts Division of Fisheries & Wildlife

Publication Information

This booklet is a publication of the Massachusetts Division of Fisheries and Wildlife (MassWildlife). MassWildlife is a state agency with a history that dates back to 1866. The agency's mission is "to protect, conserve, restore and manage inland species of fish, plants and wildlife, and their habitat, for the benefit of the people of the Commonwealth." MassWildlife is concerned for the welfare of all fish and wildlife including rare and endangered species and is staffed with professional biologists who inventory, conduct research and develop management plans to insure their continued existence in the Commonwealth. Balancing the needs of people and wildlife is an ongoing mission.

Publication of this booklet is funded in part by a grant from the U.S. Fish and Wildlife Service.

Copies of this publication are available from the Massachusetts Division of Fisheries and Wildlife, One Rabbit Hill Road, Westborough MA. 01581. Copies can also be found in libraries throughout the Commonwealth and online at www.masswildlife.org.

This guide should be cited as:

Langlois, S.A. and T.A. Decker. 2004. *The Use of Water Flow Devices and Flooding Problems Caused by Beaver in Massachusetts* (Rev. Ed.). MA Division of Fisheries and Wildlife. 18pp.

Acknowledgments

This booklet is a compilation of existing manuals, guides and research material regarding methods to address problems caused by beaver. Sources of information for this publication drew heavily from two existing comprehensive publications: *The Beaver Handbook: A Guide to Understanding and Coping With Beaver Activity* by R.G. D'Eon, R. Lapointe, N. Bosnick, J.C. Davies, B. MacLean, W.R. Watt and R.G. Wilson (Published by the Ontario Ministry of Natural Resources, Northeast Science and Technology, 1995, 76pp. available from Lakehead University Bookstore (807) 343-8589); and *Beaver Damage Control Techniques Manual*, compiled by the New York State Department of Environmental Conservation's Bureau of Wildlife by D. Hamelin, D. Dougherty, G. Fuerst, D. Jenks, T. Raffaldi, V. Gilligan, G. Golja and B. Tullar, 1997, 40pp. Sections of these publications are presented verbatim within this booklet. We are indebted to these agencies and their authors for the use of their materials in this booklet.

We also thank David Gabriel for layout and design and Peter Mirick for design and editorial review. Nancy Haver and Shayna LaBelle-Beadman provided illustrations and drawings. Reference to a specific product or manufacturer does not imply endorsement by the Massachusetts Division of Fisheries & Wildlife.



MassWildlife

Table of Contents

| | |
|--|----|
| Introduction | 4 |
| Beaver Management in Massachusetts | 4 |
| Dealing with Flooding Problems Caused by Beaver | 4 |
| Complaint Procedures | 5 |
| Water Control | 5 |
| Removing or Breaching Beaver Dams | 5 |
| Road Culvert | 6 |
| Culvert Guards, Meshes and Grills | 6 |
| Pitchfork-shaped Guard - Removable Pull Rod Grill..... | 7 |
| Beaver Fences..... | 7 |
| Deep Water Fence | 8 |
| Special Concerns Regarding Water Level Control Devices | 9 |
| How Does a WLCD Function? | 9 |
| Why Should a WLCD be installed? | 9 |
| Where can a WLCD be used? | 9 |
| Water Level Control Device Installation | 10 |
| Site Preparation | 10 |
| Water Level Control Device Materials | 10 |
| Combination Deep Water Fence/Pipe | 11 |
| Clemson Beaver Pond Leveler | 11 |
| Pond Drain Pipes | 13 |
| Maintenance of Water Level Control Devices | 13 |
| Frequency | 13 |
| Maintenance | 13 |
| Seasonal Considerations | 13 |
| Additional Considerations for Proactive and Preventive Measures | 14 |
| Road Design Considerations at Water Crossings | 14 |
| Road design in Conjunction with Forest Cutting Practices | 15 |
| Modifying Sites to Discourage Beaver Occupation | 16 |

Introduction

This manual is designed as a reference tool for people who are incurring beaver problems. It explains how to obtain information regarding current regulations to alleviate such problems, and provides information on the various techniques currently available to resolve flooding problems caused by beaver activity. While the techniques covered here are highly effective at some problem sites, none will work in every situation; all have limitations, and sometimes unsuitable side effects or unacceptable costs. This manual provides the information necessary to determine which technique, if any, is the best option for any particular situation.

Information on beaver biology, natural history, population dynamics and the positive and negative aspects associated with beaver can be found in a companion publication entitled: *Beavers in Massachusetts: Natural History, Benefits, and Ways to Resolve Conflicts Between People and Beaver*. This publication is available at all MassWildlife offices (see list at back of booklet), the University of Massachusetts at Amherst Cooperative Extension Office and at our website www.masswildlife.org.

Beaver Management in Massachusetts

The statewide beaver management program includes public education, wetland management, and an annual regulated harvest season used to control the beaver population. This program also allows for traditional, cultural, social and economic activities, along with the utilization of a secure, sustainable wildlife resource.

Specific Goals for Beaver:

- Maintain beaver populations compatible with available habitat.
- Minimize beaver complaints and property damage caused by beaver.
- Allow a sustainable public harvest of beaver, to control the beaver population within population density goals.
- Manage beaver for their aesthetic, economic, consumptive and ecological wetland values.

Dealing with Flooding Problems Caused by Beaver

The number of complaints and the amount of damage caused by beaver in the state is directly related to the size of the beaver population. Historically, beaver abundance was influenced by two predators: timber wolves and people. With the extirpation of wolves and the lack of any diseases in our region of the country that effect beaver populations on a large scale, the only factor left that can control beaver numbers today is regulated trapping.

The number of beavers in Massachusetts has typically been controlled by the number of beaver harvested by the public under regulated trapping seasons. Regulated trapping supports many of the management goals for beaver. The public may engage in the cultural and traditional uses of the resource, the beaver population can be maintained at levels compatible with existing habitat, and the amount of property damage incurred by the general public is reduced. The best prevention is to control the growth and maintain the beaver population at suitable levels.

However, the adoption of an anti-trapping ballot referendum in 1996 has severely hampered the ability of fur trappers to control beaver, hence problems related to beaver activity are increasing statewide. The net effect of the law actually maximizes the number of beavers found in Massachusetts. A maximized beaver population maximizes the amount of property damage and other related beaver problems incurred by citizens.

The state's beaver management program has historically regulated the number of beavers afield, maintaining the population at levels compatible with suitable habitat for beaver. The new law eliminates proactive regulated management, yielding an uncontrolled expansion of the beaver population. It allows the citizens of Massachusetts to take only reactive measures to beaver that cause property damage.

Complaint Procedures

Please contact a MassWildlife office (listed on page 17 of this booklet) for information on current permitting regulations regarding beaver complaints.

Breaching, disturbing or removing beaver dams. State law makes it illegal for any person to disturb or tear open a beaver dam or beaver lodge without written permission from MassWildlife and the local Conservation Commission or Department of Environmental Protection. Permits are needed to disturb a beaver dam for any reason in Massachusetts. Even dams that cause flooding require permits to be breached. Disturbing beaver dams includes breaching a dam (removing sticks, mud, rocks), adding vegetation and/or mud onto a dam, or installing a water flow device through a dam. If the complainant does not own or legally control the site where the beaver dam is located, it is their responsibility to obtain permission to go on lands he or she does not own or legally control to carry out the permitted actions.

Disturbing a beaver dam without a permit may result in fines of up to \$25,000 per day for each day the dam is illegally breached.

Water Control

Since beavers have the ability to build dams to impound water systems, they can dramatically alter the environment in which they live. When this activity is in conflict with human land use practices, it can result in extensive complaints due to damage caused by flooding. Techniques used to mitigate the flooding damage caused by beaver include breaching of beaver dams, protecting road culverts with fences or guards, and controlling water levels with water flow devices. All these techniques require a certain degree of effort and regular maintenance to insure water levels that can be tolerated (thereby preserving the positive aspects of the associated wetland).

Initial costs to install and maintain culvert guards/meshes or water flow devices can be less than the costs to repair roads, property or buildings damaged by flooding. Recognizing chronic or potential problem sites and taking proactive preventive measures may be more cost effective in the long run.

Removing or Breaching Beaver Dams

Dam breaching is an immediate but very short-term solution to flooding problems caused by beaver. Beavers usually rebuild dams quickly, sometimes enlarging them in the process or creating step dams throughout the watershed. Beavers are most active at night. Therefore, dams should be breached in the morning to allow water to flow all day.

If the complete draining of a beaver pond is warranted, it is more successful during the dry summer months when there is less available water to resupply the ponds that are being drained. Ponds that are supplied by seasonal runoff can sometimes be drained during dry periods so as to discourage beaver and cause them to relocate. It may also be advantageous to eventually dismantle the entire dam once the beaver flowage is abandoned. A narrow notch in the dam of an abandoned pond is easily plugged by wandering beavers.

Dismantling by hand. Potato hoes or stone hooks are the best tools for dismantling dams by hand. Shovels and spading forks are ineffective. Good water con-

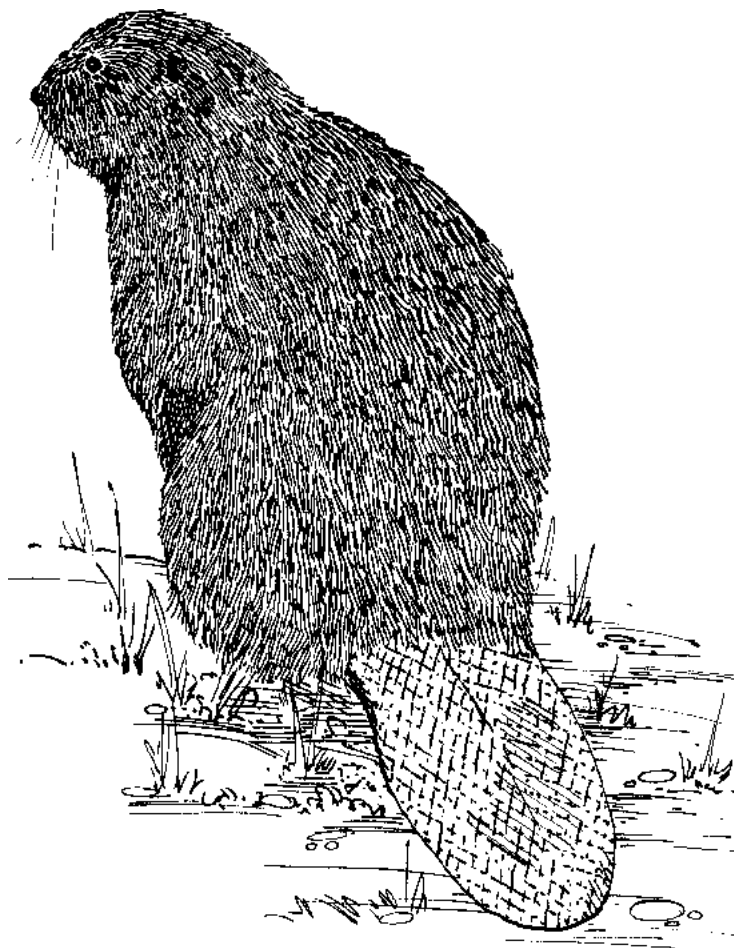

ontrol is possible if the breach is kept shallow and broad so that the water level falls slowly. Opening a deep breach creates a dangerous situation and may cause serious flooding and erosion down stream.

Power Excavating. Tractor or truck mounted excavators may be used by town, county or state highway employees to remove large amounts of material from beaver dams but care should be taken to avoid downstream flooding. Neighbors should be told where, when, and why a dam excavation is going to be done. If the method is justified and must be used, it is best done in mid-summer when the water is low.

Road Culverts

The dam construction activity of beavers is instinctive behavior. It is believed to be a combination of water flow sensation and the sound associated with running water that stimulates the dam building activity. Culverts, especially ones made out of metal, will resonate the sound of the water rushing through them. Thus, beaver will commonly block road culverts with sticks, mud and rocks. Culverts blocked from the inside are difficult to clean and potentially dangerous. The use of meshes and grills, placed on both the *upstream* and *downstream* ends of the culvert, can prevent beavers from entering.

Precautions for working around road culverts.

Working around road culverts and other water control structures can be hazardous. Appropriate safety measures must be taken. Be aware of the following:

- fast flowing water
- irregular and slippery bottoms
- cold water
- being drawn into a culvert
- isolated work sites
- unstable pond bottom

Culvert Meshes and Grills: Pros (+) and Cons (-)

- + Relatively inexpensive
- + Easy Installation
- + Works well if regular cleaning can be maintained
- Requires frequent and regular cleaning
- May reduce discharge capacity (water flow) from original culvert design
- May block fish passage
- May be damaged by ice

Culvert Guards, Meshes and Grills

These devices prevent beaver from building a dam *inside* a culvert. This is a preventive measure and not a water regulation device. If beavers build a dam in front of the culvert, other measures should be taken

(Note: It is not safe to constrict the flow of water through a road culvert. Culvert guards must be as open as possible, regularly inspected and cleared of debris. It is also extremely hazardous to stand in the water in front of a culvert while unblocking it or to crawl into one to open it.).

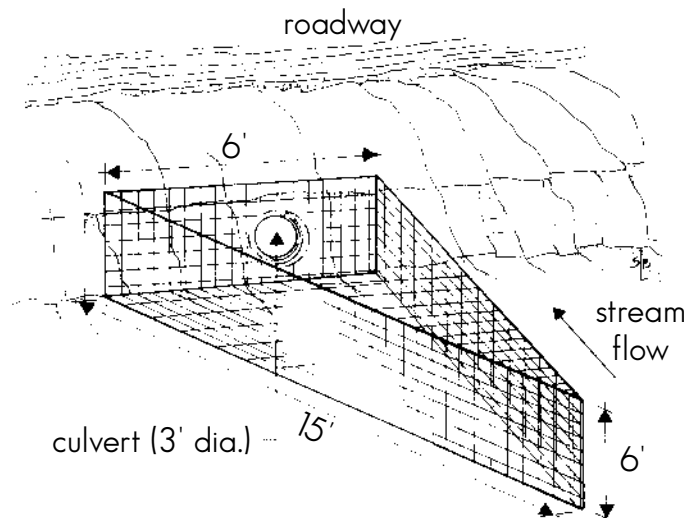

Triangular screen mesh design Constructed from 2" mesh welded wire; placed on upstream end of culvert; should be removed during winter to prevent ice damage. Dimensions shown are for a 1 meter culvert, increase measurements if required. (Drawing not to scale).

Pitchfork-shaped guard - Removable Pull Rod Grill

This is made of 1/2"-3/4" heavy steel rods welded 6" apart and held together only at the top with two horizontal braces or a piece of 3 to 4 inch channel iron. This device is held in place by the current and by driving the vertical rods about 6 inches into the streambed in front of the culvert. It is a preventive measure to keep wandering beaver from getting inside a culvert and plugging it.

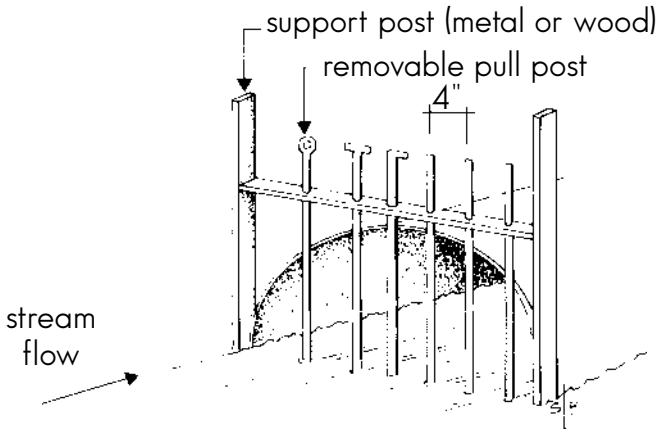

Removable pull rod grill is easier to remove than wire mesh because there are no horizontal bars to catch deposited material. After most material is cleared, posts can be pulled out, allowing the current to wash away any remaining material.

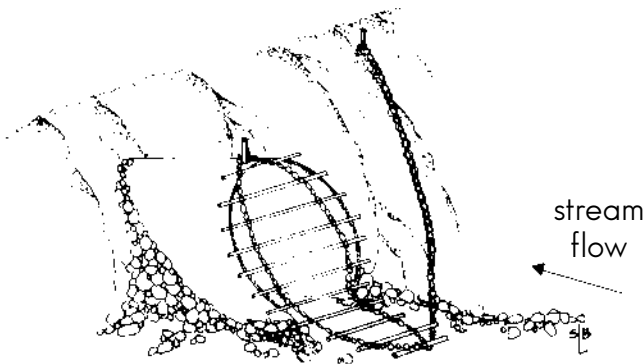

Culvert protector-cleaner Constructed by welding steel rods (4 inches apart) across a looped chain: upper end is held by a bolt placed through the top of the culvert; tail end is looped back and anchored on road bank; end of chain can then be attached to a vehicle and the grill flipped up onto the road to clear culvert

Electric breach guard - This is an electrically charged, smooth wire fence with dangling bobs. It is constructed in front of a dam to keep beaver away from a breach or away from a previously blocked

culvert. A rigid main wire is suspended above the water on floats. Several short "dangle" wires hang from this main wire. These wires extend within an inch of the surface. When a beaver swims up to inspect the breach in the dam, it will receive a shock when it touches one of the dangle wires.

The main advantage of the beaver shocker is that it is easy to install and is a fairly compact device to carry in the field. The device has to be checked daily after the installation until the beavers receive a shock and learn to leave it alone. Since the depth of the breach in the dam determines the depth of the water in the pond, a wide range of water level control can be provided with the use of this device. If the water becomes too shallow behind the dam, beaver may try to build a dam around the upstream side to try to neutralize the device.

Both the energizer and battery are expensive and are often stolen. Therefore, we suggest the use of a box with a lock for security. Maintenance is minimal. The device must be checked for battery condition and to make sure there is no debris in the breach that might short out the system and shorten the life of the battery. For these reasons, this device is often ineffective if not inspected and serviced frequently.

Beaver Fences

The purpose of the beaver fence is to physically exclude beaver from plugging the intakes of road culverts and prevent them from detecting the flow of water into the culvert.

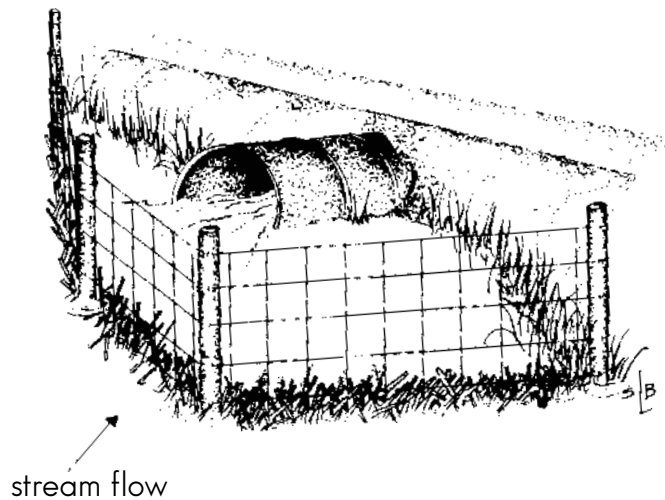

Beaver Fence Constructed on upstream side of a culvert, it keeps the culvert clear and allows high water to flow over dam and through the culvert.

Beaver Fences: Pros (+) and Cons (-)

- + Maintains culvert clear and intact
- + High water flows will spill over dam and through culvert
- + Maintains constant water level
- + In conjunction with beaver pipes, can regulate water levels
- Can be expensive, especially if area to be fenced is large
- Usually requires regular maintenance
- Can create impoundment which will affect road or railbed characteristics
- Beavers may build dam higher than roadbed, which may flood road on sides of impoundment
- May reduce water flow and fish passage

Deep Water Fence

These D-shaped or square fences, 10' to 20' on each side, are made of 6" by 6" reinforced steel mesh held by 6' steel fence posts. They are placed above intakes to prevent floodwater debris or beaver from blocking a culvert. If beaver place material against the fence, the resulting dam becomes a temporary emergency spillway which must be removed or modified to prevent the road grade from becoming a dike. If a Water Level Control Device (WLCD) is to be used in a culvert, it should be used in conjunction with a deep-water fence.

Deep-water Fence Installation Guidelines

1. Beaver must be prevented from gaining access to the culvert by keeping the wire enclosure tight against the bottom and extending the wire 18-24 inches above the surface of the water. It may be necessary to lay mesh across the top surface as well.

2. The enclosure must be of sufficient size to effectively eliminate the sensation of waterflow entering the culvert. If material is deposited on the wire and it becomes a temporary dam, the flow capacity of the enclosure must be at least equal to that of the road culvert. A 10' by 10' area is generally adequate.

3. The larger the enclosure, the more effective it is in reducing the sensation of flow. Culverts with high flow may require larger enclosure.

4. In areas with uneven bottoms, a floor may be added to prevent beaver from swimming underneath the enclosure.

Materials needed

1. 6" x 6" mesh concrete reinforcement wire (6 gauge) has been found to exclude beaver and still allow debris to pass through. This comes in 5' x 10' panels and in 60" wide rolls.

2. Heavy duty steel posts.

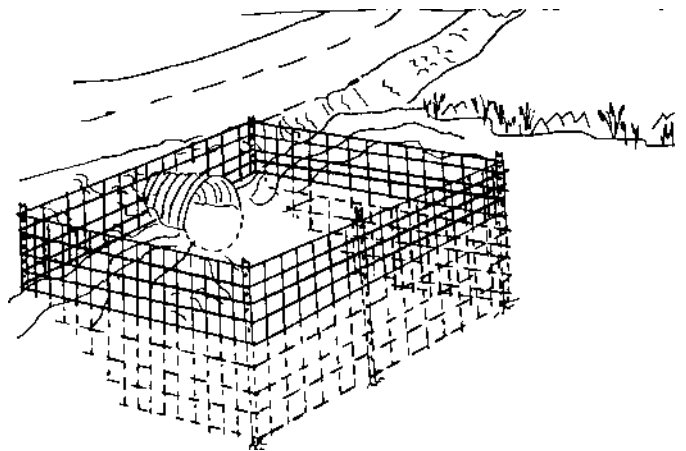

If beavers do begin to construct a dam against a fence installed to protect a culvert, it may then be necessary to install a WLCD to regulate the water level. The deep-water fence protecting the culvert will act as an emergency spillway during high run-off conditions when the WLCD cannot handle the flow. (Note: Road grades cannot usually be used as dikes. Deposited debris may have to be removed or modified.)

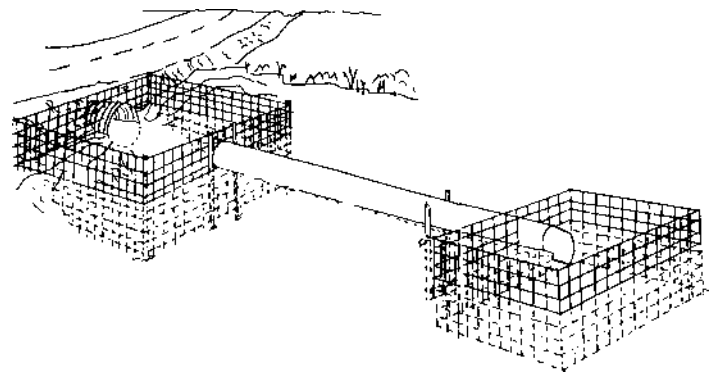

Water Level Control Devices

Special Concerns Regarding Water Level Control Devices

An assortment of Water Level Control Devices (WLCD) are available today. All have advantages and disadvantages associated with their use, and they vary in terms of expense, maintenance requirements and performance. (None are 100% effective.) The use of WLCDs does not eliminate the need to control beaver populations, but may increase tolerance for beaver activity in a specific area. It is usually the application and modification of a few techniques, used in combination, that is most beneficial at a specific site.

One significant drawback is that very few beaver problems (i.e.: 4.5% in Massachusetts; 3% in New York) can actually be solved with a water level control device. Because considerable time and money is required to build, install and maintain a WLCD, it is important to choose a site carefully. Even where one can be successful, a complainant must be committed to the concept. It is likely to fail if not regularly inspected and maintained. Therefore, consider the following before installing a WLCD:

How does a WLCD function?

a. By excluding and regulating. The best devices keep beaver away from their intakes and regulate the water level in the pond. Some devices only delay the beaver from getting to the intake of the device and merely slow them from plugging it.

b. The best devices muffle the sound of escaping water and make the sensation of flow undetectable. An example would be the Clemson pipe or combination deep water fence and pipe.

c. The level at which a beaver pond may be held and have the beaver remain varies. The depth of the lodge or burrow entrance may be used to gauge this level. If the pond is drawn too low and the beavers are unable to neutralize the device, the beaver must either build another dam upstream or downstream, or abandon the pond.

Why should a WLCD be installed?

a. To prolong the life of a desirable beaver wetland. However, few sites can support beaver for more than a few years if young beavers are not harvested each year.

b. To resolve a dispute between adjacent property owners affected by the same beaver. One or both owners must agree to purchase materials and to assemble, install, and maintain the device.

Where can a WLCD be used?

a. Only in a beaver dam that does not directly involve a water control box, dike, or man-made structure. Structures for retaining or passing water must handle runoff of severe storms; partial obstruction of these can be disastrous. Never restrict flow capacity from the original design. (See "Use of WLCD in Road Culverts").

b. Only in beaver dams where temporary flooding will do little harm. A WLCD should not be installed where flooding to the original level cannot be tolerated. It is important not to underestimate the flow rate when installing pipe style WLCDs. Inadequate size tubing will result in persistent flooding problems.

c. In areas where there is minimal opportunity for beaver to neutralize the pipe's effectiveness. A WLCD should not be installed in a dam if there are constrictions in the topography downstream of the site. A drainage that provides countless dam sites should be avoided.

d. In beaver ponds with pool depth of 4 feet or more. A WLCD can be installed in less water, but only if the device disguises the flow of water into the intake and/or the intake is protected by an enclosure.

e. In ponds with clay or gravel bottoms. Soft mucky or silty bottoms allow beaver the material for blocking WLCD intakes. This is especially true for WLCDs that have intakes that are not protected by enclosure or do not disguise the flow of water.

f. Only in accessible sites. People must get to the site easily for construction, inspection, and maintenance.

WLCD Installation

Site Preparation

Prior to installing a WLCD in a beaver dam, the water level in the pond should be lowered to the installation height. Large amounts of water flowing through a narrow opening in the dam not only make installation more difficult, but can be dangerous as well. Depending on the physical characteristics of the pond, the length of time needed for drawdown may vary from a few hours to overnight.

WLCD Materials

Polyvinyl chloride (PVC) pipe is quieter than most other suitable materials but is limited to diameters of 10" or less because of weight. The Clemson pipe, made with this material, is especially effective.

Corrugated Flexible polyethylene tubing must be protected from beaver chewing by wrapping it with chicken or welded wire. It tends to float, so it must be staked down every 5 to 10 feet. It is also limited to diameters of 10" or less, but is the cheapest material available.

Corrugated galvanized steel pipe is limited to small diameters (less than 8") because of weight and high cost. It's more likely to attract beaver plugging, because water causes excessive noise when passing through it.

Welded wire cylinders must be reinforced to prevent crushing by beaver and are seriously weakened by corrosion. They often become non-degradable litter because they are very difficult to remove. However, they are cheap, easily carried to remote sites, and can be used for quick relief until a more suitable device can be assembled.

CAUTION

WATER LEVEL CONTROL DEVICES
(WLCD) WORK ONLY IN A LIMITED
NUMBER OF SITUATIONS

Many important details must be
considered

Use of Water Level Control Devices in Road Culverts

If a decision is made to install a water control device in a road culvert, the device must be able to handle at least the same amount of water as the road culvert to avoid road flooding.

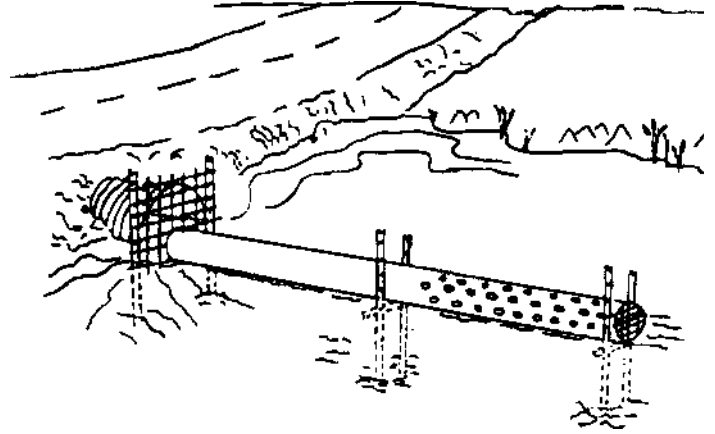

Incorrect Installation

The example above shows a water level control device that passes water directly into a screened-off culvert. The screening is easily plugged, which will leave only the device — much smaller in diameter than the road culvert — to pass the same volume of water the culvert was originally designed to handle. This will undoubtedly lead to road flooding during high water periods.

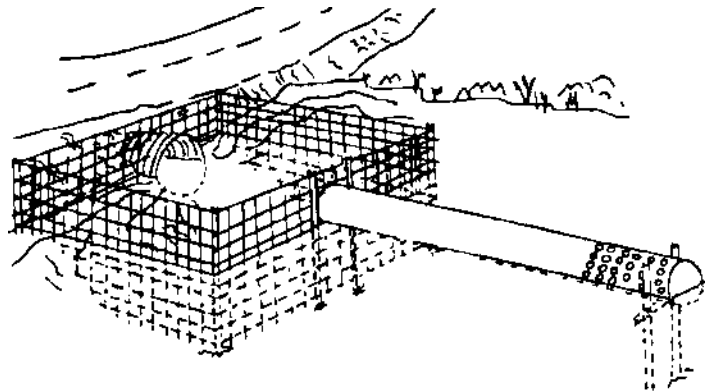

Correct Installation

This example shows a much better design: even if the screening is blocked and the water control device cannot handle the water flow, the fenced off enclosure will simply act as an emergency spillway, and road flooding will be avoided.

Culvert Pipes Pros (+) and Cons (-)

- + Relatively inexpensive
- + Easy construction and installation
- Must be deep enough to keep intake fully submerged
- Variable success
- Usually requires regular maintenance
- Reduces amount of water passage from original culvert design
- May reduce fish passage

Combination Deep Water Fence/Pipe

This is a ten foot square or larger rectangle made of heavy reinforcing mesh or welded wire fencing placed out in the deepest water of a beaver pond. A length of solid tubing is extended from the fence through the dam at the desired water level. The fence prevents the beaver from plugging the intake of the pipe, but sometimes they build a dam around it if they hear or feel the flow of water.

Special Considerations

1. Use pipe material that conducts the least amount of sound. Rigid, smooth PVC pipe is probably the best.
2. Use 6" x 6" mesh concrete reinforcement wire (6 gauge). The mesh size is small enough to keep beaver out and still let debris through the enclosure. This wire is available in 5' and 10' panels and rolls.
3. Use of an elbow or angling the pipe so that the intake remains underwater at all times when the device is operating will cut down on the sound of flowing water.
4. The larger the enclosure, the more effective in reducing the sensation of waterflow.
5. The wire enclosure must be tight against the bottom of the pond so that beavers are unable to get underneath it, and should extend 18"-24" above the pond level. In areas with uneven bottoms, a floor may be added to prevent beaver from swimming underneath.

Clemson Beaver Pond Leveler

This is a perforated PVC pipe within a welded wire pipe and is installed so that the inlet is always submerged. It is designed to minimize the probability that current flow can be detected by beaver, hence the animals don't try to block the intake. This particular design is limited to situations where the water input to a pond is from a small stream or spring. Although, in some cases, several levelers can be combined to deal with moderate flows. It is suitable only for small watersheds. During periods of unusually high rainfall, problems related to the inability of the device to handle large amounts of water may occur. The situation must be such that occasional flooding is acceptable.

Clemson Beaver Pond Leveler Pros (+) and Cons (-)

- + Low maintenance
- + Has been used with excellent success elsewhere
- + Can control water levels
- + Can combine several levelers together in heavy flow areas
- + Much information available on construction and use
- Requires initial investment of time and money to build and install
- Intake device must be submerged to work optimally
- Not designed for high volume or fast flowing water
- May reduce water flow and fish passage

Construction and Installation Guidelines

The Clemson Leveler is designed to muffle the sound of escaping water and to make the sensation of water flow undetectable. To insure the device works properly it must be constructed and installed using the following guidelines:

1. The intake should be installed so that it is always underwater. This helps to eliminate the sound of the water trickling.

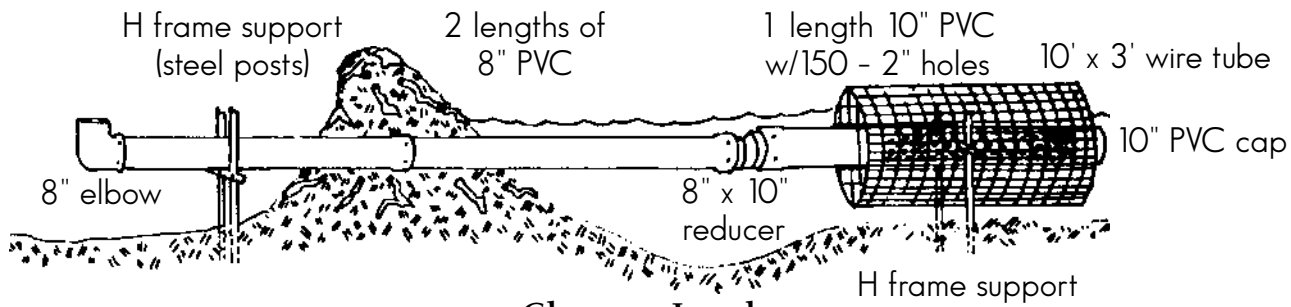

Clemson Leveler

2. Two features are required to help reduce the sensation of water flowing. First, the intake has 150 2-inch holes drilled into the 10-inch PVC which is protected by a 3-foot diameter wire pipe enclosure. Second, the 10-inch diameter intake device is reduced down to 8 inch PVC pipe.

3. An 8-inch PVC is installed on the end of the device facing up. This helps to keep the intake of the leveler under the surface of the water.

4. The farther the outlet is from the dam, the less attractive it is to beaver.

5. Because the intake of the pond leveler must be under water, there must be a minimum depth of 2 feet of water at the location of the pond leveler.

List of Materials

- 1...13' section of 10" diameter SDR-35 pipe
- 1...10"x8" SDR-3 pipe reducer coupling
- 2...13' sections of 8" diameter SDR-35 pipe
- 1...10" SDR-35 PVC cap (wooden plug may be substituted)
- 1...8" elbow (SDR-35)
- 2...96" sections of 6"x6"x60" concrete reinforcement wire

- 1...96" section of 2"x4"x72" galvanized welded wire
- 1...96" section of 2"x4"x48" galvanized welded wire
- 2...48" sections of 6"x6"x60" concrete reinforcement wire
- 1...box of hog rings
- 20...Drill point screws to secure the PVC pipe together
- 5...8' steel "lug-u" posts
- 4...2" 5/16" or 1/2" bolts with nuts and washers

Tie wire to attach the cage to the 10" PVC pipe
 The above listed materials are required to assemble the beaver pond leveler as shown above.

Pond Leveler Intake Construction
 (shown below)

1. Cut two 8' sections of 6"x6"x60" concrete reinforcement wire.
2. Cut the wire so that there are 6" wire ends.
3. Fold into cylinder 5' long; use the wire to fasten the cylinder together.
4. Fasten the two 5' cylinders together with tie wire; alternate the seams for a stronger cage.
5. Cap the ends of 10' long cylinder with 3' square pieces of concrete reinforcement wire.
6. Cover cage with 2"x4" mesh welded wire.

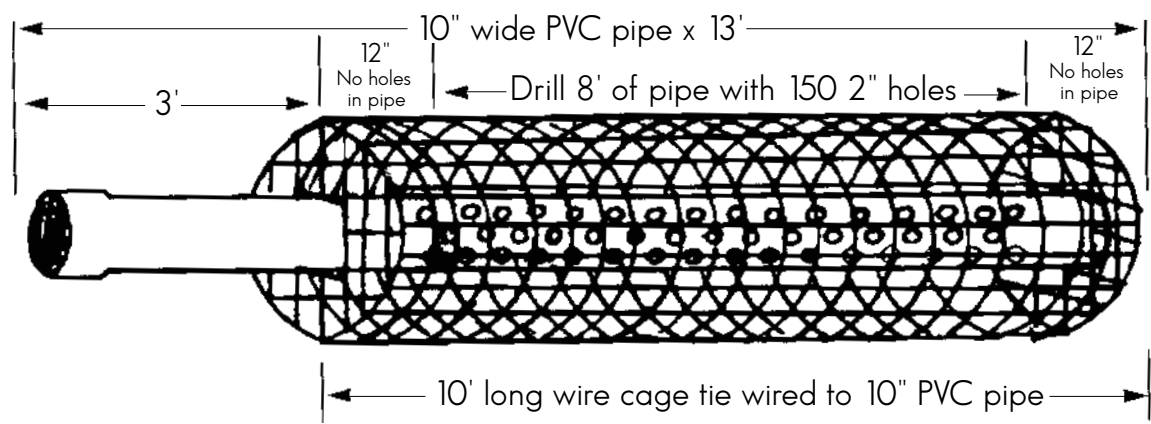

Clemson Intake Device

Pond Drain Pipes

These WLCDs do not disguise the flow of water. They are usually suspended on posts (3'- 4') above the bottom of the pond. This helps to delay the beaver from packing sediment and debris around the intake. The harder the bottom, the longer the delay. These WLCDs are less expensive and lightweight, but require more maintenance than other WLCDs.

Pond Drain Pipes Pros (+) and Cons (-)

- + Relatively inexpensive
- + Can set constant water level in beaver impoundments
- + Preserves impoundment
- Requires initial construction and installation
- Usually requires regular cleaning and maintenance
- Variable success rate

ally determines the amount of maintenance that is necessary. In general, regular pipes installed in ponds with a silt bottom require frequent cleaning to remove accumulated sediment, while those installed in ponds with gravel or hard clay bottoms need less upkeep. (The composition of pond or stream bottoms is not a factor when "Clemson Levelers" are used). Maintenance is also found to be related in part to the proximity of the beaver lodge to the installation. The flow devices located closer to active lodges may have a larger amount of plugging material, thus increasing the amount of maintenance required to keep the pipe clear of debris.

Frequency

Flow devices should be inspected a few days after installation and once again during the first month of operation. The frequency of subsequent inspections and maintenance can be judged from this and, in general, will be at least once a month thereafter.

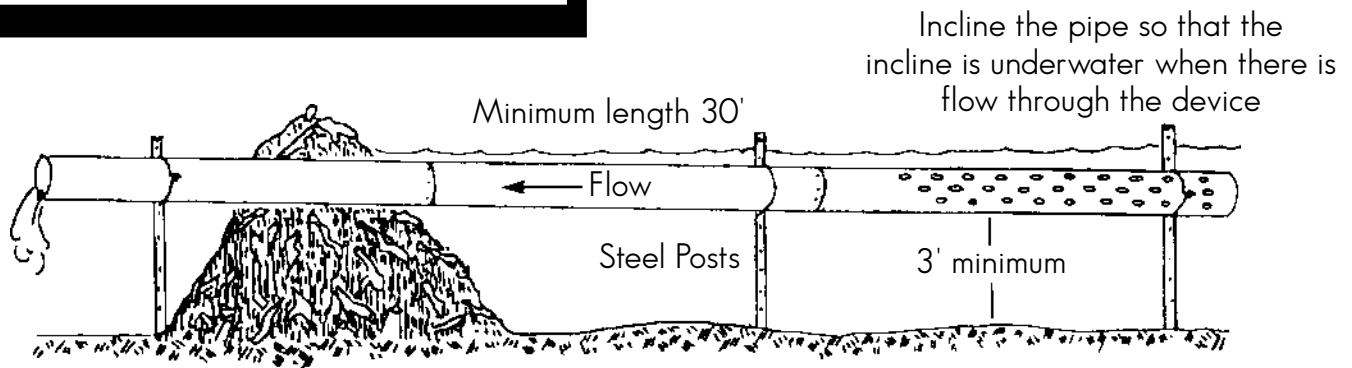

Pond Drain Pipe

Dam Installation of a Beaver Drain Pipe

1. Pipe size and material can vary depending on flow requirements and the material available.

2. Soft pond bottoms will reduce the useful life of the pipe. This WLCD lasts long in ponds with gravel or hard clay bottoms.

Maintenance of Water Level Control Devices

Beaver pipes need regular maintenance to remain functional. Maintenance requirements vary greatly with the individual installation and with the season. The composition of the pond or stream bottom usu-

Maintenance

After beavers rebuild the dam, they may extend it back along the pipe for a short distance. Maintenance consists of cleaning out this debris along the underside of the pipe with a potato hook or by hand. Beavers may also try to plug the outlet end of the pipe by piling brush on it. This is usually unsuccessful and normally does not interfere with the function of the pipe.

Seasonal Considerations

During the fall, pipes may get clogged with leaves and other debris which needs to be removed. Pipes not adequately cleaned in the fall usually need

cleaning in the spring. All pipes should be checked for ice damage in the spring because they may dislodge from their support posts. The amount of summer maintenance depends upon the total rainfall and seasonal flow in the stream bed, as well as the composition of the stream bottom.

Monthly inspections are generally adequate to keep pipes functional. However, unless this maintenance is carried out, more than half of the pipes installed will fail.

Additional Considerations for Proactive and Preventive Measures

The following sections introduce additional considerations to help reduce the potential for beaver problems in an area. All of these methods propose ways to alter the area to make the site less attractive to beaver. Unfortunately though, it may also alter habitat for other flora and fauna. Please be aware that all of these methods are highly regulated. The application of any method must be reviewed on a site by site basis. The governing state agency that has authority over the activity is provided at the beginning of each section for your information.

Road Design Considerations at Water Crossings

(These activities are governed by Massachusetts Wetland Protection Act Regulations (310 CMR 10.00). Contact your local Conservation Commission or state Dept. of Environmental Protection office for filing information).

Proactive strategies such as designing road structures to anticipate beaver problems or selecting appropriate sites for water crossing can prove very effective. Structure types available include bridges, round culverts, pipe-arch culverts, horizontal ellipse culverts, and arches.

Understanding beaver behavior can improve structure design. Since the sound of water flowing over rocks or logs or rippling through a culvert will stimulate a beaver to build a dam, the road designer may select a structure with a large area opening to accommodate the natural channel and minimize water flow noise. Also, metal tends to amplify sound so utilizing other materials in place of steel culverts, such as wooden bridges or concrete structure, can reduce noise.

When planning the route a road will take and where it will cross the stream, try to avoid areas where a beaver flowage has previously existed. Although the area is presently inactive, it is typical for beaver to re-occupy a site once the food base has regenerated. One should also avoid areas where a food supply such as Aspen, Willow or Balsam Poplar is in abundance.

Since it is more difficult for beaver to dam an area with steep gradients and fast-moving water, locating a structure (e.g. bridge or arch) at rapids or riffles with gradients more than 6 percent (slope of 16.7H:1V) can help avoid beaver problems. Since structures in areas with steep gradients can impact fish passage, it is recommended that bridges or arches be used. Culverts should only be installed in areas with a zero or minimal gradient.

Fish passage is required for all anadromous fisheries and certain rare/endangered fisheries and is advisable for all cold water trout streams. To address fish passage, designers should check water velocities in a structure to reduce noise and to compare velocities against fish swimming speeds over the length of the structure. Designing for fish passage may automatically “beaver-proof” the structure.

At existing structures the water channel at the outlet can often be altered. Adding rip rap across the channel downstream of the structure will cause ponding water to back up into the structure. This flooding will raise the water level in the structure, effectively slowing the water flow velocity and reducing the noise. By creating several shallow ponds (steps) fish passage is provided.

Once a structure is sized and installed, it is important to remember that future installation of water control devices (e.g. simple screens at the inlet and outlet) may reduce the structure’s capacity to pass flood flows. Generally, a culvert in a pond may be submerged up to one-half of its opening height without impairing its capacity to pass water. If the culvert will be submerged more than one-half of its opening height, then a larger structure will be required. Devices that diminish flow should be removed during flood periods and in the autumn prior to freeze up. Often these devices become clogged with debris and must be cleaned.

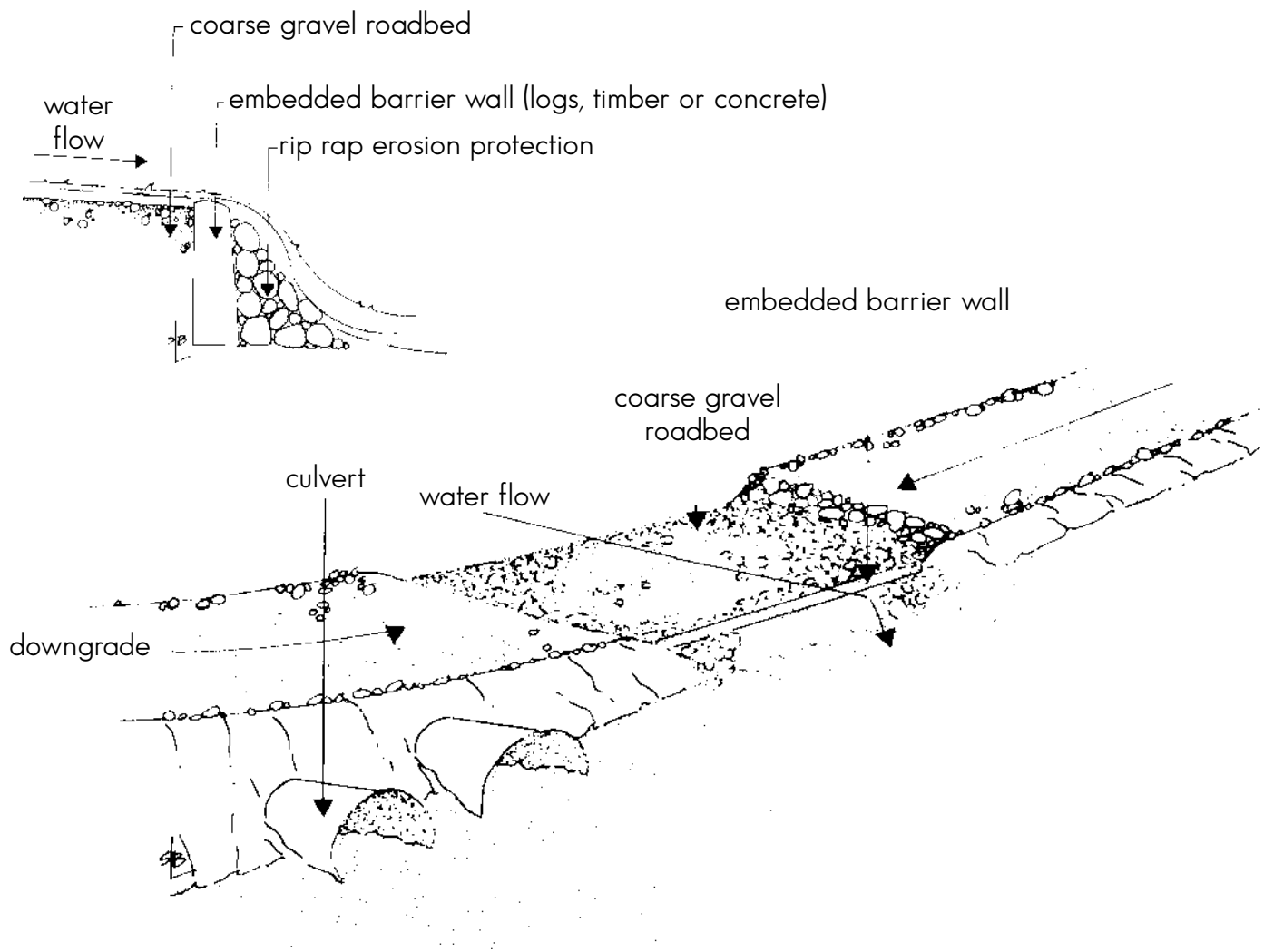

Low water crossing If we can accept the fact that a road will experience periodic flooding, then the road can be designed to receive the flowing water with minimal or no damage.

Road design in conjunction with Forest Cutting Practices

(This activity is governed by Massachusetts Forest Cutting Practices Act (132 CMR 40-46). Contact your regional office of the Department of Conservation and Recreation for filing information).

To minimize road maintenance where beaver problems are anticipated on lower standard roads, designers can provide a dip or shallow spillway on the road itself to pass flooding caused by beavers. This is known as a “low water crossing” or a “wet crossing.”

If designers recognize that there may be a future beaver problem and choose to accept the occasional flooding of the road, then the entire section of road that is expected to be flooded can be reinforced with rip rap. The surface of the spillway would be coarse gravel or rip rap sized to stay in place against flood

water velocities, with smaller stones on the road and larger boulders on the downstream road side slope where water velocities would be greatest. In some cases, logs have been used at the edge to provide for a uniform overflow and resist erosion. This will minimize road washouts.

Another consideration during the planning stages of a road is how the road, and specifically, how the water crossing will be abandoned when it is no longer required. This is particularly true in areas of beaver activity, since the water crossings will no longer be maintained. For environmental reasons, it is now required to remove the crossings and stabilize the stream banks to prevent long-term erosion. (Refer to the *Massachusetts Forestry Best Management Practices Manual* for regulatory requirements and guidance).

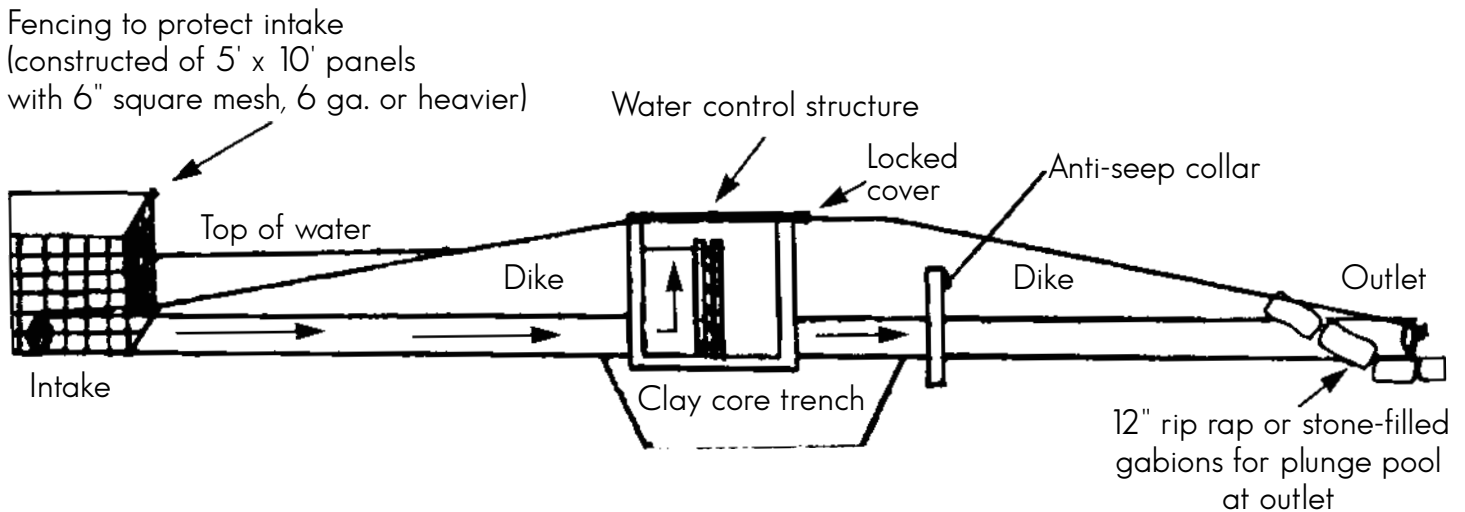

Cross Section of Low Level Dike and Water Control Structure

Modifying Sites to Discourage Beaver Occupation

(Contact your local Conservation Commission or state Dept. of Environmental Protection office for filing information).

If possible, include beaver damage prevention, water control techniques or structures in initial engineering plans. For instance, once an area has been altered by road construction, it is best to augment these areas by seeding or planting with new vegetation to stabilize the soil and minimize erosion. *At chronic sites, it may be feasible, to replace material beaver might use to construct dams and/or utilize as a food source with native herbaceous plants which can be maintained by mowing.* To make mowing easier, the banks of drainage ditches and man-made ponds should be gently sloping. This not only discourages beaver from burrowing and creating a bank lodge but minimizes the probability of dam construction. This technique can be effective if implemented immediately upstream and downstream of road culverts.

Beaver activity can also be discouraged by eliminating pools and creating riffle areas *leading into* road culverts. This can be accomplished through mechanical grading and placement of coarse stone or rubble in the stream bed. This prevents beaver from obtaining mud and/or from moving material to a site which they have previously dammed. Beavers are also less

likely to construct dams in high gradient areas. Again, this is most effective when woody vegetation from the immediate area is replaced with a native herbaceous mix. (Contact the Natural Heritage Program for guidance.)

Water control technology should be incorporated into engineering designs for pond and marsh construction. In shallow water impoundments, dikes should be constructed with wide bases, gentle slopes, and be no higher than the top of the water control box. This control should be an in-line water control structure placed in the center of the dike or as far away from the intake as possible. The top of the box should be protected with a locked cover. Water levels should be maintained so that the intake remains completely under water. The intake should also be protected with a deep water cage or fence to prevent beaver or flood debris from plugging it.

There are two main objectives with this design. One is to minimize washout potential by constructing a wide, low level dike. The other is to disguise the flow of water at the intake and protect the water control box from beaver activity.

If you have a beaver complaint or would like more information on controlling beaver damage, contact the nearest Division of Fisheries and Wildlife District office.

Western Wildlife District
400 Hubbard Avenue
Pittsfield, MA 01201
(413) 447-9789

Northeast Wildlife District
Harris Street, Box 2086
Acton, MA 01720
(978) 263-4347

Connecticut Valley Wildlife District
341 East Street
Belchertown, MA 01007
(413) 323-7632

Southeast Wildlife District
195 Bournedale Road
Buzzards Bay, MA 02532
(508) 759-3406

Central Wildlife District
211 Temple Street
West Boylston, MA 01583
(508) 835-3607

Field Headquarters
1 Rabbit Hill Road
Westboro, MA 01581
(508) 792-7270

Additional Contacts:

Natural Heritage & Endangered Species Program
Div. Fisheries and Wildlife
Field Headquarters
Westboro, MA 01581
(508) 792-7270

Dept. of Conservation and Recreation
Division of State Parks & Recreation
251 Causeway Street, Suite 600
Boston, MA 02114
(617) 626-1250

Dept of Environmental Protection,
Div. of Wetlands and Waterways
One Winter Street
Boston, MA 02108
(617) 292-5500

MASSACHUSETTS WILDLIFE

Four Issues Per Year



Photocopy and Mail!
Subscribe today to *your* outdoor magazine.
Yes! I'm enclosing \$6. Please start my subscription with the next issue.
Name _____
Address _____
City _____ State _____ Zip _____

- TRADITION** - Fifty years at the forefront of superb wildlife reporting.
- BEAUTY** - Exceptional nature photography.
- VARIETY** - From Cape Cod beaches to the Berkshire Hills.
- ACTION** - Tips on hunting, fishing, wildlife viewing, Follow biologists in the field.
- VALUE** - **One year subscription: only \$6!**

Send check or money order to:
MASSACHUSETTS WILDLIFE
Division of Fisheries & Wildlife, Dept. WCD2004
Field Headquarters, Westboro, Massachusetts 01581