

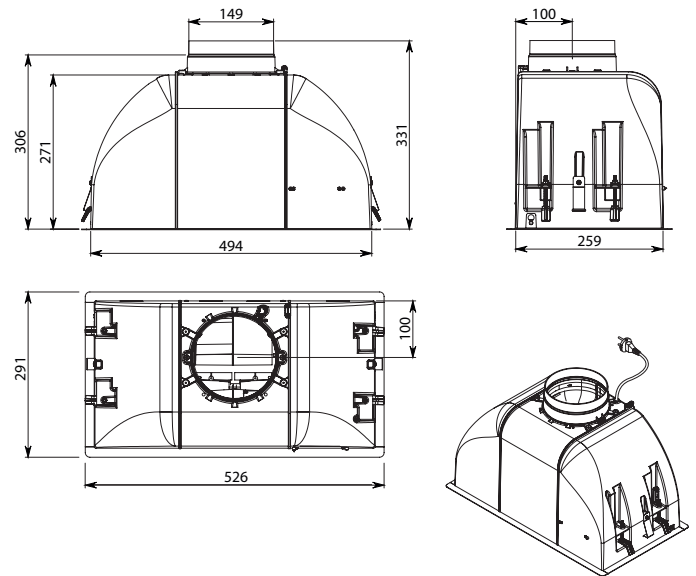

Product Features

<b>Motor Type</b>	On Board Motor
<b>Dimensions</b>	531(W) x 320(H) x 294(D)mm Suits 50cm-90cm Cooking Surfaces
<b>Cut-Out</b>	506 x 262mm
<b>Filtration Type</b>	Perimeter Suction
<b>Controls</b>	Soft Touch Control
<b>Lighting</b>	2 x Dynamic LED
<b>Speed Settings</b>	3 Speed + Boost
<b>Timer Function</b>	15 Min Auto Shut-Off
<b>Ducting</b>	150mm Circular Outlet
<b>Remote Control</b>	Optional
<b>Grease Filter Alarm</b>	Yes
<b>Dishwasher Safe Filters</b>	Yes
<b>Charcoal Filter</b>	Yes

Dimensioned Drawings



\* Semi-rigid or rigid ducting recommended.

Model Code	Size	Motor Output	Finish
F3GI60S1	60cm	800 m <sup>3</sup> /hr	Stainless Steel

## GRUPPO INCASSO

### Version

Built-in 60 cm - 800 m<sup>3</sup>/h

### Collection

Design

### EAN code

8034122353395

## MOTOR TECHNICAL SHEET

Motor speed	1	2	3	4
Noise level dB(A) <sub>re1pW-I.E.C.60704-2-13</sub>	49	55	61	67
Capacity (m <sup>3</sup> /h) I.E.C.61591	270	360	470	670
Maximum pressure (Pa)	390	420	460	500
Motor Power (W)	134	156	180	215
Air outlet	150	150	150	150

## CAPACITY / PRESSURE

