

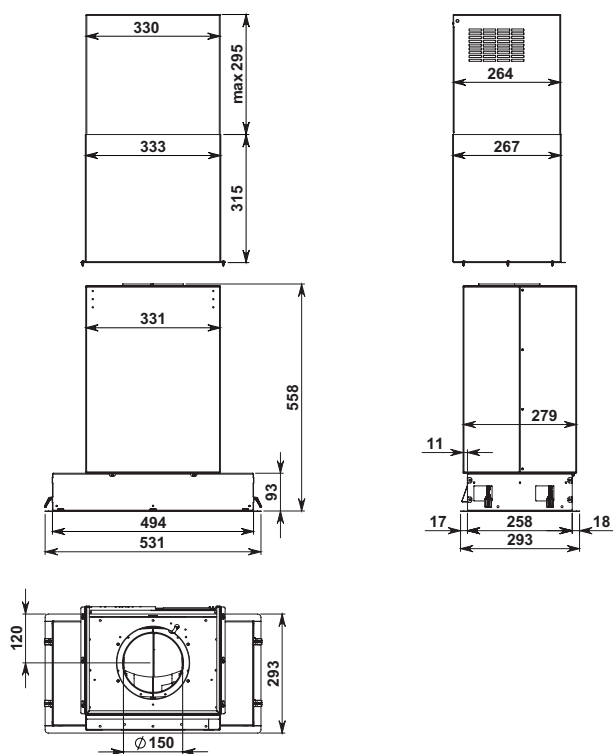

Product Features

Motor Type	On Board Motor
Dimensions	531(W) x 558(H) x 293(D)mm Suits 50cm-90cm Cooking Surfaces
Cut-Out	506 x 262mm
Filtration Type	2 x Aluminum Mesh Filters
Controls	Electronic Control
Lighting Type	2 x Dynamic LED
Speed Settings	3 Speed + Boost
Timer Function	15 Min Auto Shut-Off
Duct Outlet	150mm Circular
Optional Accessories	Charcoal Filters
Remote Control	Included
Grease Filter Alarm	Yes
Dishwasher Safe Filters	Yes

Dimensioned Drawings



Model Code	Size	Motor Output	Finish
F3GN60S1	60cm	800 m³/hr	Stainless Steel

GRUPPO INCASSO NRS

Version

Built-in 50 cm - 800 m3/h

Collection

Silence - NRS

EAN code

8034122343105

MOTOR TECHNICAL SHEET

Motor speed	1	2	3	4
Noise level dB(A)re1pW-I.E.C.60704-2-13	37	41	46	54,5
Capacity (m3/h) I.E.C.61591	220	290	375	610
Maximum pressure (Pa)	390	440	490	510
Motor Power (W)	130	150	178	224
Air outlet	150	150	150	150