



INSTRUCTION MANUAL

VHF MARINE TRANSCEIVER
GM600



Icom Inc.

Thank you for choosing this Icom product.

This product is designed and built with Icom's state of the art technology and craftsmanship.

With proper care, this product should provide you with years of trouble-free operation.

The GM600 VHF MARINE TRANSCEIVER has the Class A DSC functions for a distress alert transmission and reception, as well as the general DSC calls (Individual call, All Ships call, Group call, and so on).

You must connect the GM600 to the DC power supply through the PS-310 DC-DC POWER SUPPLY that is sold as a set with the GM600.

EN60945 Environmental category

The GM600 is protected from the weather.

The PS-310 is protected from the weather.

IMPORTANT

READ ALL INSTRUCTIONS carefully and completely before using the transceiver.

SAVE THIS INSTRUCTION MANUAL — This instruction manual contains important operating instructions for the GM600.

EXPLICIT DEFINITIONS

WORD	DEFINITION
 WARNING!	Personal injury, fire hazard or electric shock may occur.
CAUTION	Equipment damage may occur.
NOTE	If disregarded, inconvenience only. No risk of personal injury, fire or electric shock.

DISPOSAL



The crossed-out wheeled-bin symbol on your product, literature, or packaging reminds you that in the European Union, all electrical and electronic products, batteries, and accumulators (rechargeable batteries) must be taken to designated collection locations at the end of their working life. Do not dispose of these products as unsorted municipal waste. Dispose of them according to the laws in your area.

Icom, Icom Inc. and Icom logo are registered trademarks of Icom Incorporated (Japan) in Japan, the United States, the United Kingdom, Germany, France, Spain, Russia, Australia, New Zealand, and/or other countries.

IN CASE OF EMERGENCY

If your vessel requires assistance, contact other vessels and the Coast Guard by sending a Distress call on Channel 16.

USING CHANNEL 16

DISTRESS CALL PROCEDURE

1. "MAYDAY MAYDAY MAYDAY."
2. "THIS IS" (name of vessel).
3. Say your call sign or other description of the vessel (AND 9 digit DSC ID if you have one).
4. "LOCATED AT" (your position).
5. State the nature of the distress and assistance required.
6. Give any other information which might facilitate the rescue.

Or, transmit your Distress call using digital selective calling on Channel 70.

USING DIGITAL SELECTIVE CALLING (Ch 70)

DISTRESS CALL PROCEDURE

1. While lifting up the key cover, hold down [DISTRESS] for 3 seconds until you hear 3 short beeps and then one long beep.
2. Wait for an acknowledgment on Channel 70 from a coast station.
 - After the acknowledgement is received, Channel 16 is automatically selected.
3. Hold down [PTT], then transmit the appropriate information as listed above.

INSTALLATION NOTE

Installation:

The installation of this equipment should be made in such a manner as to respect the EC recommended electromagnetic field exposure limits. (1999/519/EC)

The maximum RF power available from this device is 25 watts. The antenna should be installed as high as possible for maximum efficiency and the installation height should be at least 1.76 meters above any accessible position. In the case where an antenna cannot be installed at a reasonable height, then the transmitter should neither be continuously operated for long periods if any person is within a distance of 1.76 meters of the antenna, nor operated at all if any person is touching the antenna.

It is recommended that antenna of a maximum gain of 3 dB is used. If higher gain antenna are required then please contact your Icom distributor for revised installation recommendations.

Operation:

The exposure to RF electromagnetic field is only applicable when this device is transmitting. This exposure is naturally reduced due to the nature of alternating periods of receiving and transmitting. Keep your transmissions to the minimum necessary.

PRECAUTIONS

⚠ **WARNING! NEVER** connect the transceiver to an AC outlet. This may pose a fire hazard or result in an electric shock.

⚠ **WARNING! NEVER** connect the transceiver to an external DC power supply directly. The transceiver must be connected to the DC power supply through the PS-310 DC-DC POWER SUPPLY that is sold as a set with this transceiver. Be sure to not connect with reverse polarity.

PS-310's version	Input voltage	Output voltage
#01	21.6 to 31.2 V DC	12.6 V DC
#02	10.8 to 15.6 V DC	12.6 V DC

⚠ **WARNING! NEVER** cut the DC power cable between the DC plug at the back of the transceiver/PS-310 and the fuse holder. If an incorrect connection is made, the transceiver may be damaged.

CAUTION: NEVER place the transceiver where normal operation of the vessel may be hindered, or where it could cause bodily injury.

KEEP the transceiver and microphone at least 1 meter away from the vessel's magnetic navigation compass.

DO NOT place or leave the transceiver in areas with temperatures below -15°C or above $+55^{\circ}\text{C}$, or in areas subject to direct sunlight, such as a dashboard.

DO NOT use harsh solvents such as Benzine or alcohol to clean the transceiver, as they will damage the transceiver's surfaces. If the transceiver becomes dusty or dirty, wipe it clean with a soft, dry cloth.

BE CAREFUL! The transceiver rear panel will become hot when operating continuously for long periods of time.

Place the transceiver in a secure place to avoid inadvertent use by unauthorized persons.

BE CAREFUL! The transceiver's front panel meets IPX7* requirements for waterproof protection. However, once the transceiver has been dropped, or the waterproof seal is cracked or damaged, waterproof protection cannot be guaranteed because of possible damage to the case or the waterproof seal.

*The connectors on the rear panel do not meet IPX7.

If the front panel is exposed to saltwater, **BE SURE TO CLEAN IT THOROUGHLY WITH FRESH WATER** when the front panel's waterproof protection is effective. Otherwise, the keys and switch may become inoperable due to salt crystallization.

COUNTRY CODE LIST

• ISO 3166-1

	Country	Codes		Country	Codes
1	Austria	AT	18	Liechtenstein	LI
2	Belgium	BE	19	Lithuania	LT
3	Bulgaria	BG	20	Luxembourg	LU
4	Croatia	HR	21	Malta	MT
5	Czech Republic	CZ	22	Netherlands	NL
6	Cyprus	CY	23	Norway	NO
7	Denmark	DK	24	Poland	PL
8	Estonia	EE	25	Portugal	PT
9	Finland	FI	26	Romania	RO
10	France	FR	27	Slovakia	SK
11	Germany	DE	28	Slovenia	SI
12	Greece	GR	29	Spain	ES
13	Hungary	HU	30	Sweden	SE
14	Iceland	IS	31	Switzerland	CH
15	Ireland	IE	32	Turkey	TR
16	Italy	IT	33	United Kingdom	GB
17	Latvia	LV			

ACTION ICON DESCRIPTION

The following describes the [CH/ENT], [ENT] and the keypad operations in this instruction manual.

Rotate



: Rotate [CH/ENT] to select.

Push



: Push [ENT] to enter or set.

Push



: Push the keypad to enter a digit or text.

Also, you can use the following key functions in the Menu screen.



FUNCTION	ACTION
Select	Rotate [CH/ENT]. Push [▲] or [▼].
Enter	Push [ENT], [CH/ENT], or [Enter]  .
Go to the next tree level	Push [ENT] or [▶].
Go back to the previous tree level	Push [CLR], [◀], or [Back]  .
Cancel	Push [CLR].
Exit	Push [MENU] or [Exit]  .

TABLE OF CONTENTS

IMPORTANT.....	i	7 DSC OPERATION.....	23-75
EXPLICIT DEFINITIONS.....	i	■ DSC address ID.....	23
DISPOSAL.....	i	■ Entering the position and time.....	25
IN CASE OF EMERGENCY.....	ii	■ DSC Task mode.....	27
INSTALLATION NOTE.....	ii	■ Sending a Distress call.....	29
PRECAUTIONS.....	iii	■ Sending a Non-Distress call.....	42
COUNTRY CODE LIST.....	iv	■ Receiving DSC calls.....	54
ACTION ICON DESCRIPTION.....	iv	■ Received Call log.....	69
1 OPERATING RULES.....	1	■ Transmitted Call log.....	70
2 PANEL DESCRIPTION.....	2-8	■ DSC Settings.....	71
■ Front panel.....	2	8 MENU ITEMS.....	76-81
■ Software key function.....	5	■ Menu items.....	76
■ Speaker Microphone.....	5	■ Radio Settings.....	77
■ Function display (Main screen).....	6	■ Configuration.....	78
3 PREPARATION.....	9	9 CONNECTIONS AND MAINTENANCE.....	82-88
■ Entering the MMSI code.....	9	■ Connections.....	82
4 MENU SCREEN.....	10-12	■ Antenna.....	84
■ Construction.....	10	■ Fuse replacement.....	84
■ Selecting a Menu item.....	12	■ Cleaning.....	84
5 BASIC OPERATION.....	13-19	■ Supplied accessories.....	85
■ Selecting a channel.....	13	■ Power source connections.....	86
■ Setting the Call channel.....	14	■ Mounting the transceiver.....	87
■ Receiving and transmitting.....	15	■ Handset (HS-98).....	88
■ Backlight function.....	17	10 SPECIFICATIONS AND OPTIONS.....	89-90
■ Microphone Lock function.....	17	■ Specifications.....	89
■ Entering a Channel name.....	18	■ Options.....	90
5 SCAN OPERATION.....	20-21	11 TROUBLESHOOTING.....	91-92
■ Scan types.....	20	12 CHANNEL LIST.....	93
■ Favorite channels.....	21	13 DIGITAL INTERFACE (IEC 61162-1).....	94-97
■ Starting a scan.....	21	■ I/O Sentences.....	94
6 DUALWATCH/TRI-WATCH.....	22	■ Schematic diagram.....	97
■ Description.....	22	■ Hardware version.....	97
■ Operation.....	22	■ Software version.....	97
		INDEX.....	98-100

◇ **Priorities**

- Read all rules and regulations pertaining to call priorities, and keep an up-to-date copy handy. Safety and distress calls take priority over all others.
- You must monitor Channel 16 when you are not operating on another channel.
- False or fraudulent distress calls are prohibited under law.

◇ **Privacy**

- Information overheard, but not intended for you, cannot lawfully be used in any way.
- Indecent or profane language is prohibited.

◇ **Radio licenses**

(1) SHIP STATION LICENSE

You may require a current radio station license before using the transceiver. It is unlawful to operate a ship station which is not licensed, but required to be.

If required, contact your dealer or the appropriate government agency for a Ship-Radiotelephone license application. This government-issued license states the call sign which is your craft's identification for radio purposes.

(2) OPERATOR'S LICENSE

A Restricted Radiotelephone Operator Permit is the license most often held by small vessel radio operators when a radio is not required for safety purposes.

If required, the Restricted Radiotelephone Operator Permit must be posted or kept with the operator. If required, only a licensed radio operator may operate a transceiver.

However, non-licensed individuals may talk over a transceiver if a licensed operator starts, supervises, ends the call and makes the necessary log entries.

A current copy of the applicable government rules and regulations is only required to be on hand for vessels in which a radio telephone is compulsory. However, even if you are not required to have these on hand it is your responsibility to be thoroughly acquainted with all pertinent rules and regulations.

■ Front panel

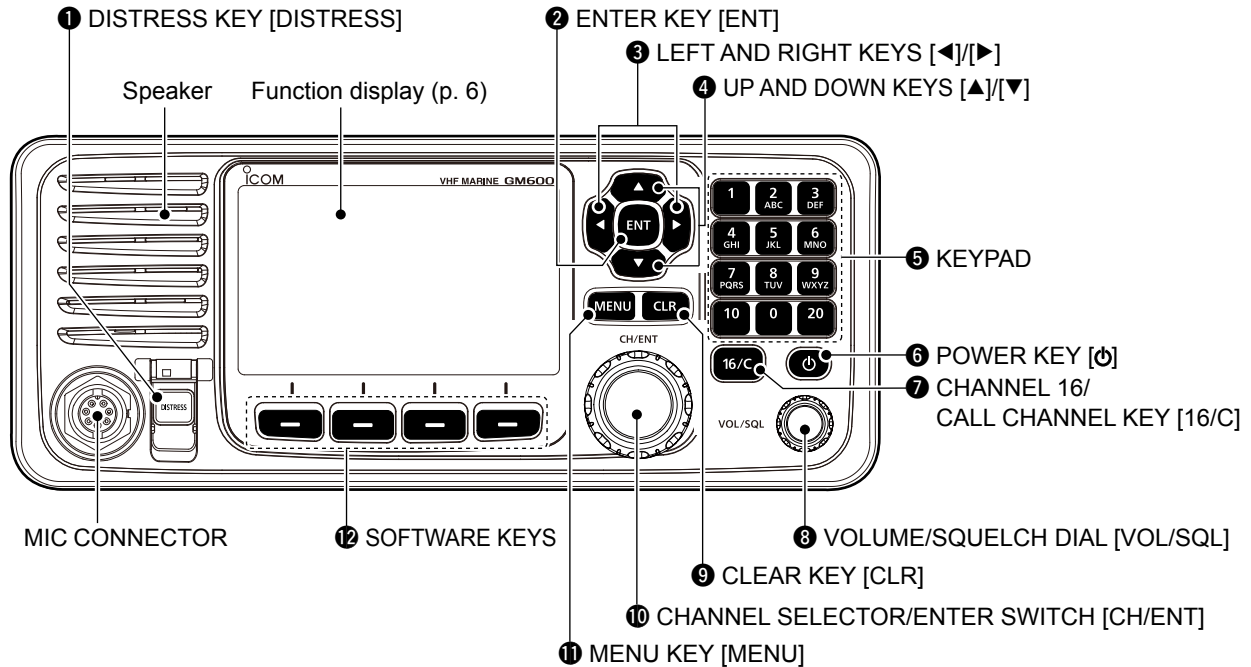

1 DISTRESS KEY [DISTRESS] (p. 29)

Hold down for 3 seconds to transmit a Distress call.

2 ENTER KEY [ENT]

Push to set the entered data, selected item, and so on.

3 LEFT AND RIGHT KEYS [◀]/[▶]

- Push to scroll the software key functions. (p. 5)
- In the character or number entry mode, push to select the desired character or number in the keypad. (p. 18)

4 UP AND DOWN/CHANNEL SELECT KEYS [▲]/[▼]

- Push to select the operating channel (p. 13), Menu items (p. 12), Menu settings (p. 12), and so on.
- While scanning, push to check the Favorite channels, change the scanning direction or manually resume a scan. (p. 21)

5 KEYPAD

Push to enter numbers, letters or symbols.
 For channel number entry, see page 13.
 For channel name entry, see page 18.

6 POWER KEY [⏻]

Hold down for 1 second to turn the transceiver ON or OFF.

7 CHANNEL 16/CALL CHANNEL KEY [16/C]

- Push to select Channel 16. (p. 13)
- Hold down for 1 second to select the Call channel. (p. 13)
 - “CALL” is displayed when the Call channel is selected.

8 VOLUME/SQUELCH DIAL [VOL/SQL] (p. 15)

- Rotate to adjust the volume level.
- Push once or twice to display the Volume or Squelch Setting screen, and then rotate to adjust the volume or squelch level.

9 CLEAR KEY [CLR]

Push to cancel the entered data, or to return to the previous screen.

10 CHANNEL SELECTOR/ENTER SWITCH [CH/ENT]

- Rotate to select the operating channel (p. 13), Menu items (p. 12), Menu settings (p. 12), and so on.
- Push to set the entered data, selected item, and so on. (p. 12)

11 MENU KEY [MENU]

Push to enter or exit the Menu screen. (p. 12)

2 PANEL DESCRIPTION

■ Front panel (Continued)

⑫ SOFTWARE KEYS (p. 5)

You can use various key functions that are assigned to the software keys, as described below.

Compose Distress* (p. 30)

Push to display the COMPOSE DISTRESS screen.

Compose Non-Distress* (p. 42)

Push to display the COMPOSE NON-DISTRESS screen.

Compose DROBOSE* (p. 36)

Push to display the COMPOSE DROBOSE screen.

Task Mode (p. 27)

When the transceiver has any task, push to enter the Task mode.

Scan (p. 21)

Push to start or stop a Normal or Priority scan.

Dualwatch/Tri-watch [DW] (p. 22)

Push to start or stop the Dualwatch or Tri-watch.

High/Low [HI/LO] (p. 15)

Push to set the output power level to high or low.
• Some channels are set to only low power.

Channel [CHAN] (p. 13)

When Channel 16 or the Call channel is selected, push to select the last selected channel.

Favorite channel [Favorite] (p. 21)

Push to set or clear the displayed channel as a Favorite channel.

Channel Name (p. 18)

Push to display the CHANNEL NAME screen.

Backlight (p. 17)

Push to open the Backlight Settings window.

DSC Log (p. 69)

Push to display the RCVD CALL LOG screen.

* These key functions are not displayed in the Radio Telephone (RT) mode. (p. 14)

■ Software key function

The transceiver has the software keys for various functions. The key function is displayed above the software key, as shown below.

◇ Selecting the software key function

When “◀” or “▶” is displayed beside the key icon, pushing [◀] or [▶] scrolls the software key functions. When you push [◀] or [▶] once, 4 functions scroll together.

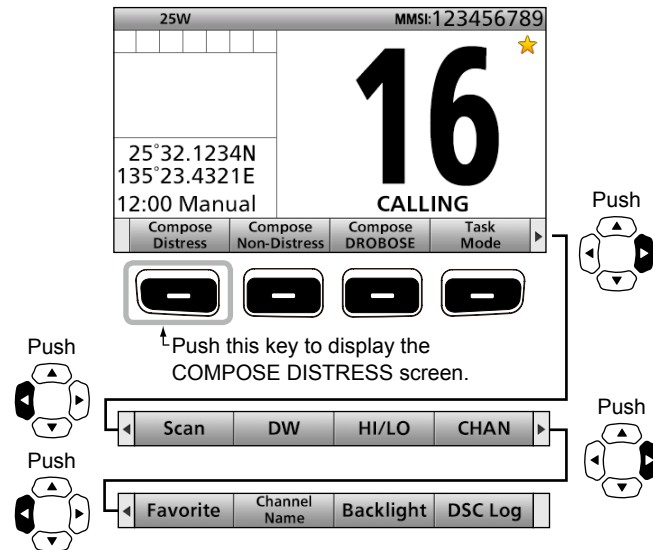

■ Speaker Microphone

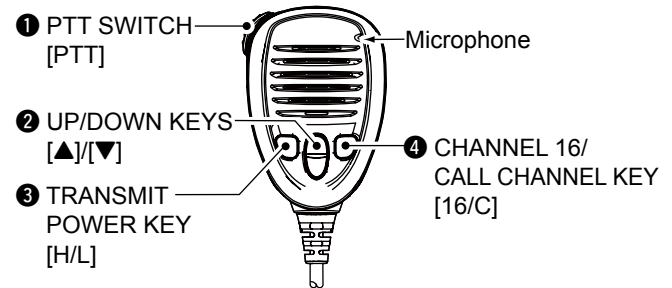

- 1 **PTT SWITCH [PTT]** (pp. 15, 29)
Hold down to transmit, release to receive.
- 2 **UP/DOWN KEYS [▲]/[▼]** (p. 21)
Push to select the Favorite channels, change scanning direction or manually resume a scan.
 - When the “FAV on MIC” item is set to “OFF,” you can select all channels. (p. 78)
- 3 **TRANSMIT POWER KEY [H/L]**
 - Push to set the power level to high or low. (p. 15)
 - Some channels are set to only low power.
 - While holding down this key, turn ON the transceiver to turn the Microphone Lock function ON or OFF. (p. 17)
- 4 **CHANNEL 16/CALL CHANNEL KEY [16/C]** (p. 13)
 - Push to select Channel 16.
 - Hold down for 1 second to select the Call channel.
 - The “CALL” icon is displayed.

2 PANEL DESCRIPTION

■ Function display (Main screen)

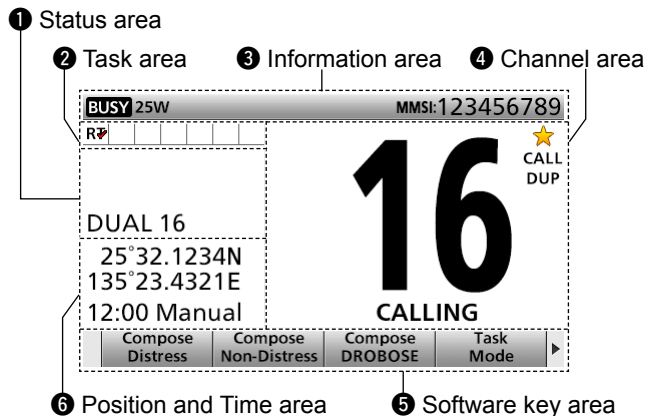

Display area	Description
1 Status area	Displays the current status.
2 Task area	Displays up to 7 task icons.
3 Information area	Displays various icons and the MMSI code.
4 Channel area	Displays the selected operating channel information. (p. 7)
5 Software key area	Displays the key function for each software key. (p. 5)
6 Position and Time area	Displays the current position and time. (p. 8)

◇ Status area

The current status is displayed in the Status area.

Indicator	Description
SCAN 16	Displayed during a Priority scan. (p. 21)
SCAN	Displayed during a Normal scan. (p. 21)
DUAL 16	Displayed during Dualwatch. (p. 22)
TRI 16	Displayed during Tri-watch. (p. 22)







◇ Task area

Up to 7 task icons are displayed in the Task area when the transceiver has a task.

Indicator	Description
RT	Displayed while in the Radio Telephone (RT) mode. (p. 14) <ul style="list-style-type: none"> • "RT" is displayed when the RT mode task is activated. • Disappears if no operation occurs during the preset period of time. (p. 80)
	Displayed after receiving a DSC call. (p. 27) <ul style="list-style-type: none"> • "↓" is displayed when the RX call task is activated.
	Displayed after making a DSC call. (p. 27) <ul style="list-style-type: none"> • "↑" is displayed when the TX call task is activated.

◇ **Information area**

The 9 digit MMSI (Maritime Mobile Service Identity: DSC self ID) code and the following indicators are displayed in the Information area.

Indicator	Description
	Displayed when receiving a signal or when the squelch is open.
	Displayed while transmitting.
25W	Displayed when high power is selected.
1W	Displayed when low power is selected.
	Displayed when the transceiver receives a valid GPS data from the GPS receiver. Blinks while invalid GPS data is being received.
	Blinks when there is an unread DSC message.
	Displayed when the "Internal Speaker" item is OFF. (p. 81)
	Displayed when the battery voltage is low.

◇ **Channel area**

The selected operating channel number, channel name, and the following indicators are displayed in the Channel area.

Indicator	Description
	Displayed when a Favorite (Tag) channel is selected.
CALL	Displayed when the Call channel is selected.
DUP	Displayed when a Duplex channel is selected.

2 PANEL DESCRIPTION

■ Function display (Main screen) (Continued)

◇ Position and Time area

POSITION AREA

The current position is displayed when valid GPS data is received, or you manually enter your position.

Indicator	Description
NO POSITION	Displayed when a GPS receiver is not connected and your position has not been manually entered.
??	Blinks every 2 seconds instead of your position when the GPS position is invalid. <ul style="list-style-type: none">• The last position is held for only 23.5 hours. After that, "NO POSITION" will be displayed.
	Blinks every 2 seconds instead of the position after 4 hours have passed since you manually entered your position. <ul style="list-style-type: none">• The manually entered position is held for only 23.5 hours. After that, "NO POSITION" will be displayed.

TIME AREA

- ➔ The current time is displayed when a valid GPS data is received, or manually enter the time.
- ➔ The date information is displayed when the RMC GPS sentence formats are included in the GPS signal.

Indicator	Description
NO TIME	Displayed when a GPS receiver is not connected and the time has not been manually entered.
Local	Displayed when the offset time is set.
Manual	Displayed when the time was manually entered.
UTC	Displayed when the GGA, GLL or GNS GPS sentence formats are included in the GPS signal.
??	Blinks every 2 seconds instead of the time when the GPS current time is invalid. <ul style="list-style-type: none">• After 23.5 hours has passed, "NO TIME" will be displayed.
	Blinks every 2 seconds instead of the time after 4 hours have passed since you manually entered the time. <ul style="list-style-type: none">• The manually entered time is held for only 23.5 hours. After that, "NO TIME" will be displayed.

■ Entering the MMSI code

First, you must enter the 9 digit MMSI (Maritime Mobile Service Identity: DSC self ID) code at power ON.

You can perform this initial code entry ONLY ONCE. After entry, only your dealer or distributor can change it. If you have already entered your MMSI code, these procedures are not necessary.

- ① Hold down [⏻] for 1 second to turn ON the transceiver.
 - Three short beeps sound.
 - “Push [ENT] to Register Your MMSI” is displayed.
- ② Push [ENT] to enter the MMSI code entry mode.

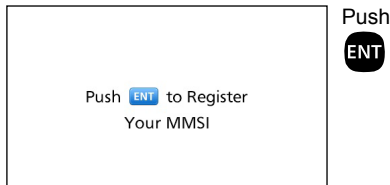

- Push [CLR] to cancel the entry. In that case, the transceiver displays “Push [ENT] to Register Your MMSI” again.

- ③ Enter your 9 digit MMSI code.

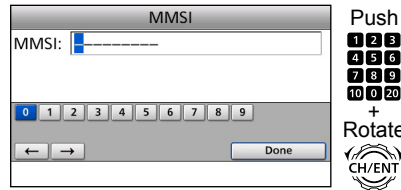

- ④ After entering the 9th digit, set the ID.

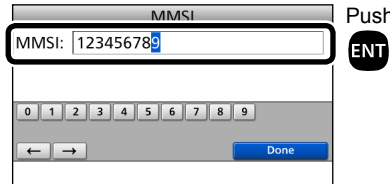

- ⑤ Reenter your MMSI code to confirm.

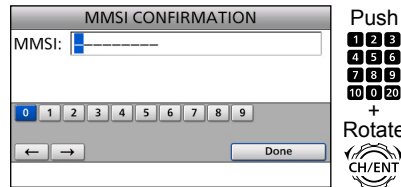

- ⑥ After entering the 9th digit, register the ID.

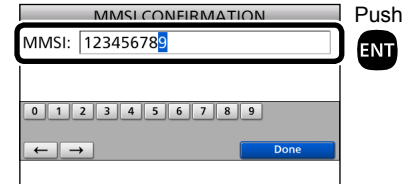

- When you successfully enter your MMSI code, the following screen is displayed.



- After that, the Main screen is displayed. The registered MMSI code is displayed at the top of the screen.

You can use the Menu screen to set infrequently changed values or function settings.

Construction

The Menu screen is constructed in a tree structure.

You can go to the next tree level with [ENT], or go back a level with [CLR]. See page iv for details.

To select an item, rotate [CH/ENT].

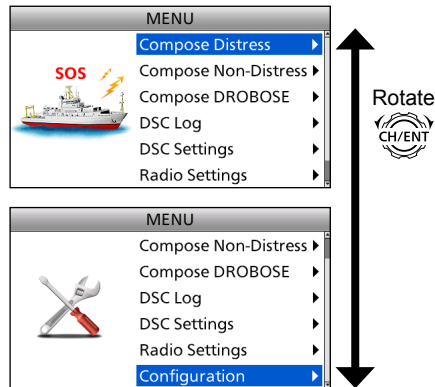

• Compose Distress (p. 30)

Nature of Distress	Select a Nature of Distress option.
Position	Enter your position.
• Latitude	Displays latitude data.
• Longitude	Displays longitude data.
• UTC	Displays UTC offset data.

• Compose Non-Distress (p. 42)

Message Type	Select a Message Type option.
Address	Enter a destination address.
Position* ¹	Enter your position.
• Latitude* ¹	Displays latitude data.
• Longitude* ¹	Displays longitude data.
• UTC* ¹	Displays UTC offset data.
Category	Select a Category option.
Mode* ¹	Select a Mode option.
Channel* ¹	Select an Intership channel.

• Compose DROBOSE (p. 36)

Message Type	Select a Message Type option.
Address* ¹	Enter a destination address.
Distress ID	Enter a Distress ID.
Nature of Distress	Select a Nature of Distress option.
Position	Enter your position.
• Latitude	Displays latitude data.
• Longitude	Displays longitude data.
• UTC	Displays UTC offset data.
Mode	Displays the communication mode.

• DSC Log (pp. 69, 70)

Received Call Log	
• Distress	Displays the received Distress call log.
• Others	Displays the received call log other than the Distress call.
Transmitted Call Log	Displays the transmitted call log.

• DSC Settings (p. 71)

Position Input* ²	Enter your position.
Individual ID	Enter an Individual ID.
Group ID	Enter a Group ID.
Individual ACK	Select an Individual ACK option.
Position ACK	Select a Position ACK option.
Polling ACK	Select a Polling ACK option.
Test ACK	Select a Test ACK option.
Medical Transports	Turn the Medical Transports call ON or OFF.
Ships and Aircraft	Turn the Ships and Aircraft call ON or OFF.
10 Second Delay	Turn the 10 Second Delay function ON or OFF.
Alarm Status	
• Safety	Turn the Alarm Status for Safety ON or OFF.
• Routine	Turn the Alarm Status for Routine ON or OFF.
• Warning	Turn the Alarm Status for Warning ON or OFF.
• Self-Terminate	Turn the Alarm Status for Self-Terminate ON or OFF.
• Discrete	Turn the Alarm Status for Discrete ON or OFF.

*¹ These items may not be displayed, depending on the "Message Type" item's option.

*² This item is not displayed, when a valid GPS data is received.

• DSC Settings (Continued)

CH70 SQL Level	Select the Channel 70 squelch level.
Auto Print	Turn the Auto Print function ON or OFF.
DSC Loop Test	Starts the DSC Loop Test.

• Radio Settings (p. 77)

Scan Type	Select a Scan Type from Normal Scan or Priority Scan
Scan Timer	Turn the Scan Timer function ON or OFF.
Dual/Tri-Watch	Select the Dualwatch or Tri-watch function.
Call Channel	Set the Call channel.
FAV on MIC	Turn the FAV on MIC function ON or OFF.
FAV Settings	Set the Favorite channel settings.

• Configuration (p. 78)

Key Beep	Turn the Key Beep function ON or OFF.
UTC Offset	Set the UTC Offset.
Inactivity Timer	Set the inactivity timer.
• Not DSC Related	Set the inactivity timer for not DSC related calls.
• DSC Related	Set the inactivity timer for DSC related calls.
• Distress Related	Set the inactivity timer for Distress related calls.
• RT Related	Set the inactivity timer for the Radio Telephone mode.
NMEA Data Output	Set the NMEA 0183 Output functions.
• DSC Data Output	Select a DSC Data Output option.
• POS Data Output	Select a Position Data Output option.
Internal Speaker	Turn the Internal Speaker function ON or OFF.
MIC Type	Select a microphone type.
Software Version	Display the software version.

4 MENU SCREEN

■ Selecting a Menu item

Follow the procedures as described below to select a Menu item.

Example: Set the Tri-watch function.

- ① Push [MENU] to display the MENU screen.
- ② Rotate [CH/ENT] to select "Radio Settings," then push [ENT].

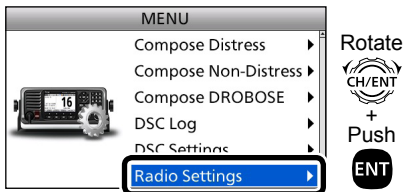

- ③ Rotate [CH/ENT] to select "Dual/Tri-Watch," then push [ENT].

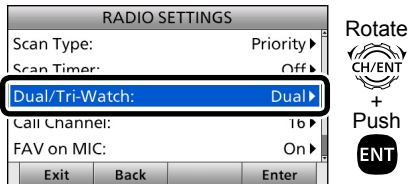

- ④ Rotate [CH/ENT] to select "Tri-Watch," then push [ENT].

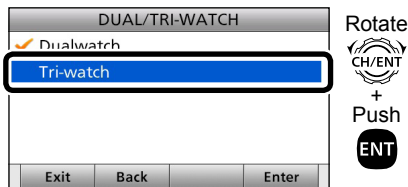

• Sets the Tri-watch function, and then goes back to the RADIO SETTINGS screen, after pushing [ENT].

- ⑤ Push [MENU] to return to the Main screen.

■ Selecting a channel

◇ Selecting a regular channel

Selecting a channel in sequence:

- ➔ Rotate [CH/ENT].
- ➔ Push [▲] or [▼].

Entering the desired channel number:

- ➔ Push the keypad to directly enter the desired channel number.

Example: Selecting Channel 22
Push [2 ABC] → [2 ABC].

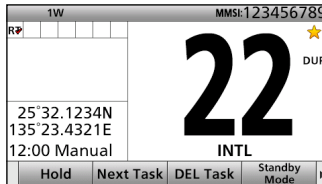

◇ Selecting Channel 16

Channel 16 is the distress and safety channel. It is used for establishing initial contact with a station, and for emergency communications. While standing by, you must monitor Channel 16.

- ➔ Push [16/C].

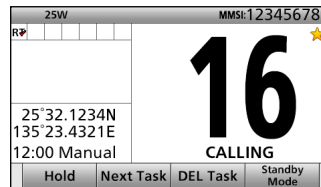

To recall the channel that was displayed before selecting Channel 16:

- ➔ Push [CHAN] .

◇ Selecting Call channel

You have a leisure use Call channel for quick recall.

To set your most used channel, see page 14.

The default Call channel is Channel 16.

- ➔ Hold down [16/C] for 1 second.

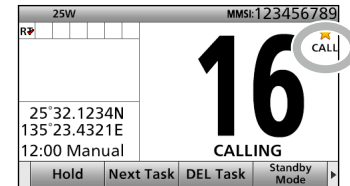

To recall the channel that was displayed before selecting Call channel:

- ➔ Push [CHAN] .

5 BASIC OPERATION

■ Selecting a channel (Continued)

TIP: After receiving a signal or you operate the transceiver, the transceiver enters the Radio Telephone (RT) mode. In the RT mode, you can make a voice communication except for the DSC operation.

- “RT” is displayed while in the RT mode.
- “RT” is displayed when the RT mode task is activated.
- “RT” or “RT” disappears if no operation occurs during the preset period of time. (p. 80)
- The following software key functions are not displayed in the RT mode.
[Compose Distress]
[Compose Non-Distress]
[Compose DROBOSE]

■ Setting the Call channel

You can set the Call channel with your most often-used channel for quick recall.

- ① Push [MENU] to display the MENU screen.
- ② Rotate [CH/ENT] to select “Radio Settings,” then push [ENT].

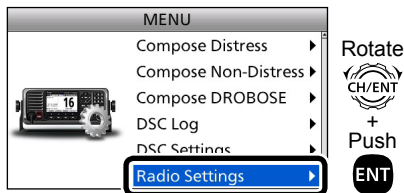

- ③ Rotate [CH/ENT] to select “Call Channel,” then push [ENT].

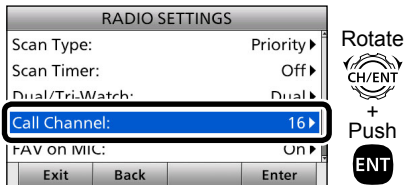

- ④ Rotate [CH/ENT] to select the desired channel to be set as the Call channel, then push [ENT].

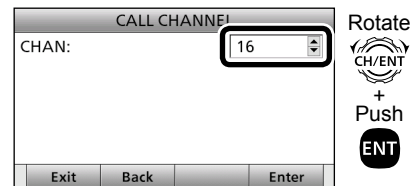

- Goes back to the previous screen, after pushing [ENT].
- ⑤ Push [MENU] to return to the Main screen.

TIP: To confirm that your setting is correctly set, hold down [16/C] for 1 second. (p. 13)

■ Receiving and transmitting

CAUTION: Transmitting without an antenna will damage the transceiver.

- ① First, turn ON the PS-310 DC-DC POWER SUPPLY.
- ② Hold down [⏻] for 1 second to turn ON the transceiver.
 - If no MMSI code is entered, “Push [ENT] to Register Your MMSI” is displayed. (p. 9)
- ③ Rotate [VOL/SQL] to adjust the audio level.



- ④ Push [VOL/SQL] once or twice to open the SQL Setting window.



- ⑤ Rotate [VOL/SQL] to adjust the squelch level until the noise just disappears.
- ⑥ Select a channel. (p. 13)
- ⑦ Push [◀] or [▶] until software key function [HI/LO] is displayed.
- ⑧ Push [HI/LO] [⏻] to select an output power high or low.

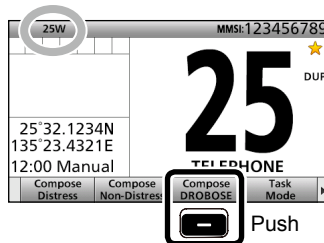

- ⑨ Hold down [PTT], and speak at your normal voice level.
 - “TX” is displayed.
- ⑩ Release [PTT] to return to receive.

NOTE:

Selecting a channel:

- When receiving a signal, “BUSY” is displayed.
- You can use Channel 70 only for Digital Selective Calling (DSC) transmissions.
- When the “FAV on MIC” item is set to “OFF,” you can select all channels using the [▲] or [▼] keys on the microphone. (p. 78)

Selecting an output power:

- “25W” is displayed when high power is selected. Choose high power for longer distance communications.
- “1W” is displayed when low power is selected. Choose low power for short range communications.
- Some channels are restricted to low power.

5 BASIC OPERATION

■ Receiving and transmitting (Continued)

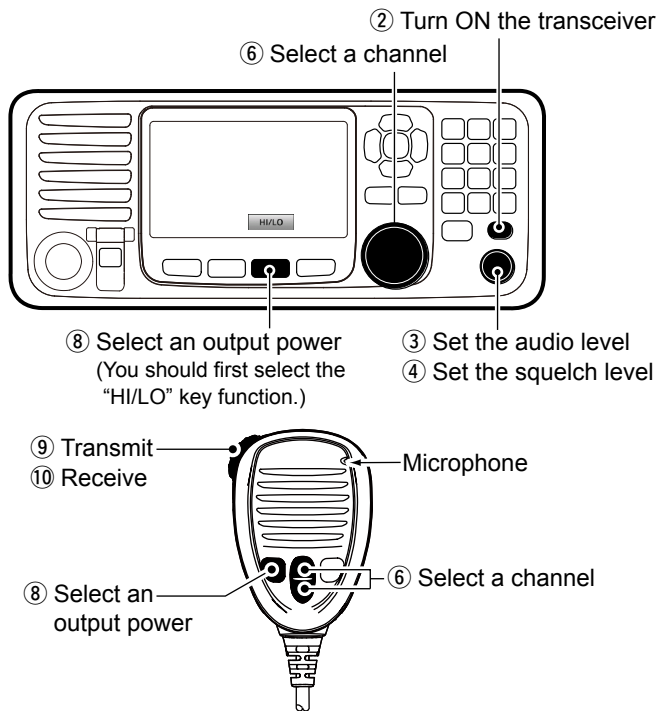

IMPORTANT: To maximize the readability of your transmitted signal at a receiver station, pause a second after pushing [PTT], and then hold the microphone 5 to 10 cm from your mouth and speak at your normal voice level.

NOTE for the Time-out Timer (TOT) function

The TOT function inhibits continuous transmission beyond a preset time period after the transmission starts. 10 seconds before transmission is cut off, a beep sounds to indicate the transmission will be cut off, and "TOT" is displayed in the channel name field. You cannot transmit again for 10 seconds after it is cut off.

■ Backlight function

The function display and keys can be backlit for better visibility under low light conditions.

And, you can set the Backlight mode to Day mode or Night mode.

The Day mode is for the daytime operation, and the screen items are in color.

The Night mode is for the nighttime operation, and the screen items are in black and red.

- ① Push [◀] or [▶] until software key function [Backlight] is displayed.
- ② Push [Backlight]  to open the Backlight Settings window.

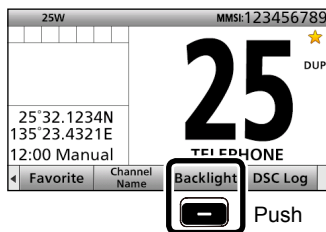

- In the Backlight Setting screen, if you push no key for about 5 seconds, the transceiver automatically returns to the Normal operation mode.

- ③ Push [▲] or [▼] to select “Day Mode” or “Night Mode.”

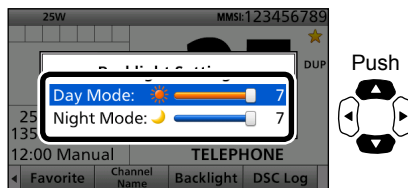

- ④ Rotate [CH/ENT] to adjust the backlight level, then push [ENT].

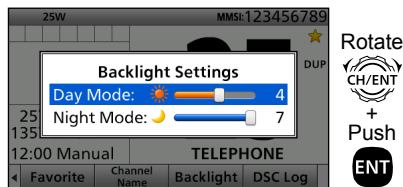

- The backlight level is adjustable in 7 levels and “OFF.”*
**“OFF” is selectable only for the Day mode.

■ Microphone Lock function

The Microphone Lock function electrically locks [▲], [▼], [16/C] and [H/L] on the supplied microphone. This prevents accidental channel changes and function access.

- While holding down [H/L] on the microphone, hold down [Ⓛ] for 1 second to turn ON the transceiver.
 - The Microphone Lock function is turned ON or OFF.

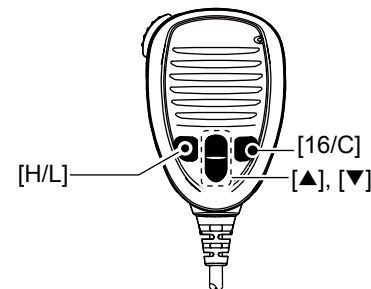

■ Entering a Channel name

You can rename each channel with a unique alphanumeric ID of up to 10 characters.

- ① First, cancel the Dualwatch, Tri-watch or Scan function, if activated.
- ② Rotate [CH/ENT] to select a channel.
- ③ Push [Channel Name] .



- ④ Enter the desired character.

Using the keypad:

Push a keypad to enter a character. (Example: Entering "S")



Push

 5 times

- To move the cursor, rotate [CH/ENT].
- You can enter the following characters by pushing the keypad one or more times.

KEY	ENTRY	KEY	ENTRY
[1]	1	[6]	6 M N O
[2]	2 A B C	[7]	7 P Q R S
[3]	3 D E F	[8]	8 T U V
[4]	4 G H I	[9]	9 W X Y Z
[5]	5 J K L	[0]	0 . (period)

Using [▲], [▼], [◀], or [▶]:

Push [▲], [▼], [◀], or [▶] to select the desired character. Then, push [ENT] to enter the character. (Example: Entering "S")



Push

 + Push
 ENT

- To move the cursor, push [▲], [▼], [◀], or [▶] to select either arrow, "←" or "→", then push [ENT].
- You can enter capital letters, 0 to 9, some symbols (! " # \$ % & ' () * + , - . / [\] ^ _ ; : < = > ?) and a space.

See 'Common operation' as described on page 19 for details of the following operations.

- Entering a symbol/space
- Deleting a character
- Canceling an entry
- Correcting an entry

Common operation

- **To enter a symbol:**
Push [“!\$?”] , then push [▲], [▼], [◀], or [▶] to select the desired character. And then, push [ENT].
 - **To enter a space:**
Push [▲], [▼], [◀], or [▶] to select a “Space,” and then push [ENT].
 - **To delete a character:**
Push [▲], [▼], [◀], or [▶] to select “Delete,” and then push [ENT].
 - **To cancel an entry:**
Push [CLR].
 - **To correct an entry:**
Move the cursor to the character, and then, enter the correct character.
- ⑤ Repeat step ④ to enter all characters.
- ⑥ Push [▲], [▼], [◀], or [▶] to select “Done,” then push [ENT].
- Return to the previous screen.
 - During the keypad operation, “Done” is automatically selected.

■ Scan types

You can find ongoing calls by scanning the Favorite channels without rotating [CH/ENT].

The GM600 has two scan types.

- Priority scan (default)
- Normal scan

PRIORITY SCAN

A Priority scan sequentially scans all Favorite channels while also monitoring Channel 16.

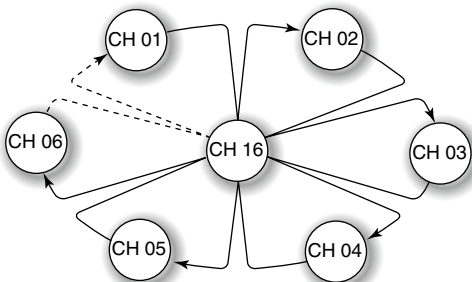

When a signal is received:

• On Channel 16

The scan pauses until the signal on Channel 16 disappears.

• On a channel other than Channel 16:

The scan switches to Dualwatch, until the signal disappears.

Before you start a scan:

- Set the desired channels you want to scan as Favorite channels. (Scans only Favorite channels.) (p. 21)
- Set the desired scan type to "Normal" or "Priority." (p. 77)

NORMAL SCAN

A Normal scan sequentially scans all Favorite channels. However, the scan does not check Channel 16 unless it is set as a Favorite channel.

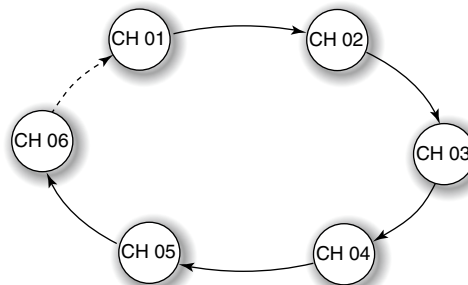

Favorite channels

You can quickly recall often-used channels by setting them as Favorite channels.

All channels are set as Favorite channels by default.

Setting

- ① Rotate [CH/ENT] to select a channel.
- ② Push [Favorite]  to set the channel as a Favorite channel.
 - “★” is displayed.

Selecting

- ➔ Push [▲] or [▼] on the microphone.
 - Non-Favorite channels are skipped and not displayed.
 - When the “FAV on MIC” item is set to “OFF,” you can select all channels. (p. 78)



TIP: You can select all channels by rotating [CH/ENT] or pushing [▲] or [▼] on the transceiver. (p. 13)

Clearing

- ① Select a Favorite channel to clear.
- ② Push [Favorite]  to clear the channel as the Favorite channel.
 - “★” disappears.

TIP: You can clear all Favorite channels in the Menu screen. (p. 78)

Starting a scan

- ① Push [Scan]  to start a scan.
 - During a Priority scan, “SCAN 16” is displayed.
 - During a Normal scan, “SCAN” is displayed.
- ② Push [Scan]  again to cancel the scan.
 - “SCAN 16” or “SCAN” disappears.

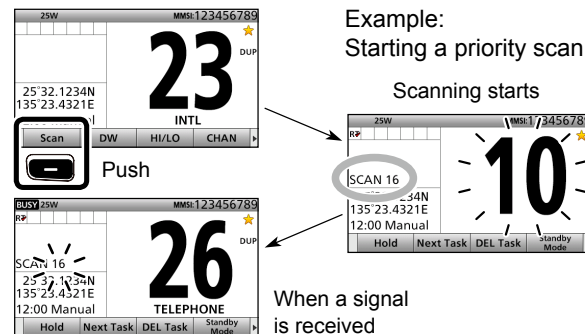

NOTE:



- When a signal is received, the scan pauses until the signal disappears, or resumes after pausing for 5 seconds, depending on the “Scan Timer” setting. (p. 77)
- You can check the scanning channel, change the scan direction, or manually resume the scan by pushing [▲] or [▼] on either the transceiver or the microphone.
- A beep tone sounds and “16” blinks when a signal is received on Channel 16 during a Priority scan.
- In order to properly receive signals, you must adjust the squelch to the proper level. (p. 15)

■ Description

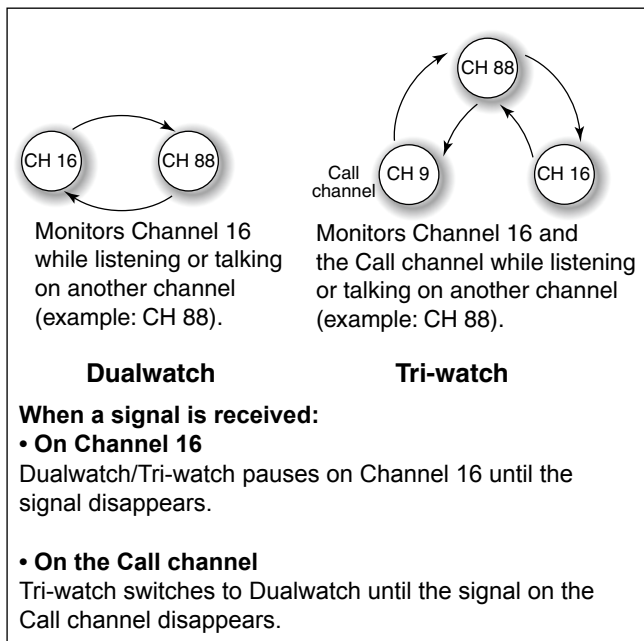
Dualwatch and Tri-watch are convenient to monitor Channel 16 while you are listening or talking on another channel.



■ Operation

- ① Select Dualwatch or Tri-watch in the Menu screen. (p. 77)
- ② Select a channel. (p. 13)
- ③ Push [DW]  to start Dualwatch or Tri-watch.
 - During Dualwatch, "DUAL 16" is displayed.
 - During Tri-watch, "TRI 16" is displayed.
 - A beep tone sounds and "16" starts to blink when a signal is received on Channel 16.
- ④ Push [DW]  again to cancel Dualwatch or Tri-watch.

Example: Operating Dualwatch on Channel 07.

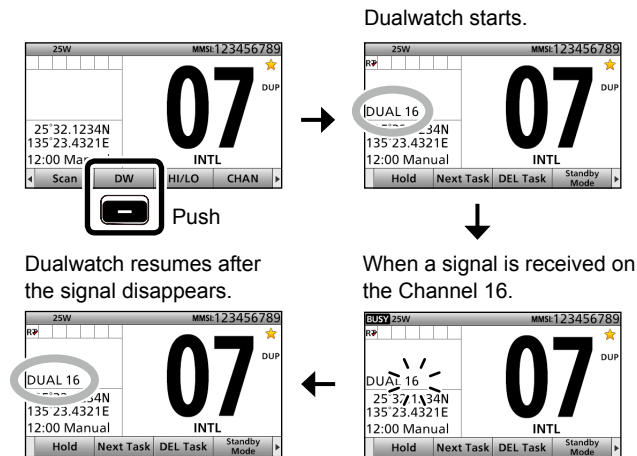

■ DSC address ID

You can enter a total of 100 DSC address IDs (Individual ID: 75, Group ID: 25), and assign a name of up to 10 characters.

◇ Entering Individual ID

- ① Push [MENU].
- ② Select "Individual ID," then push [ENT].
(DSC Settings > Individual ID)
- ③ Push [Add] .

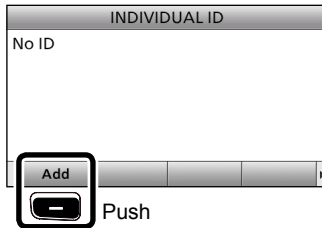

- ④ Enter a 9 digit Individual ID.

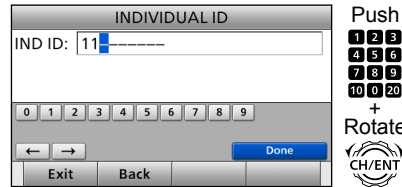

TIP: You must set the first digit for the Individual ID to between '1' and '9.'

- The first digit must be set to '0' for a Group ID.
- The first two digits must be set to '0' for any Coast station ID.

- ⑤ After entering all 9 digits, push [ENT].
- ⑥ Enter the desired ID name.

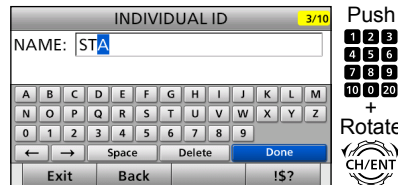

• See page 18 for text entry details.

- ⑦ After entering, push [ENT].

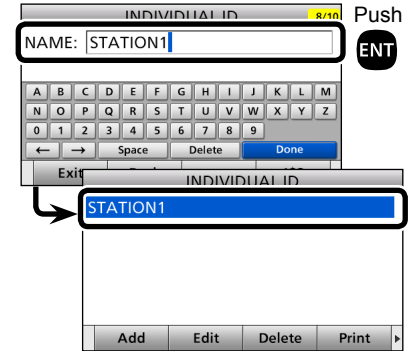

- The entered Individual ID and name are added to the ID list.
- ⑧ Push [MENU] to return to the Main screen.

8 DSC OPERATION

◆ Entering Group ID

- ① Push [MENU].
- ② Select "Group ID," then push [ENT].
(DSC Settings > **Group ID**)
- ③ Push [Add] .

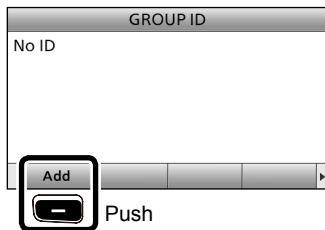

- ④ Enter a 9 digit Group ID.

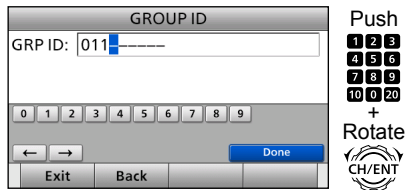

TIP: You must set the first digit for a Group ID to '0.'

- The first digit must be set to between '1' and '9' for an Individual ID.
- The first two digits must be set to '0' for any Coast station ID.

- ⑤ After entering all 9 digits, push [ENT].
- ⑥ Enter the desired ID name.

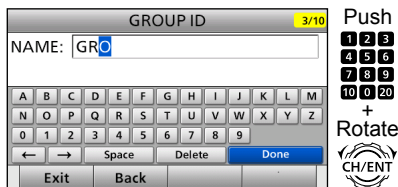

• See page 18 for text entry details.

- ⑦ After entering, push [ENT].

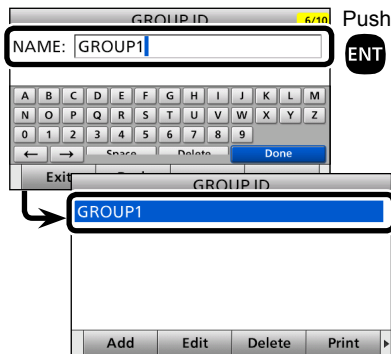



- ⑧ Push [MENU] to return to the Main screen.

◆ Deleting an entered ID

- ① Push [MENU].
- ② Select "Individual ID" or "Group ID," then push [ENT].
(DSC Settings > **Individual ID**)
(DSC Settings > **Group ID**)
- ③ Rotate [CH/ENT] to select the ID to delete.

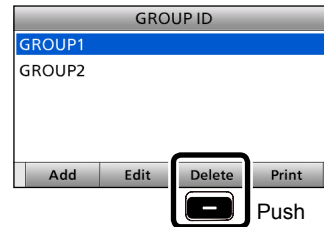
- ④ Push [Delete] .



- ⑤ Push [OK] .

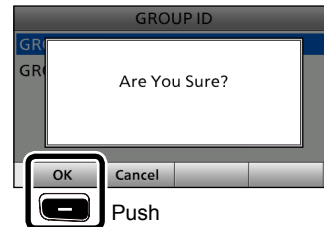

• After deleting, returns to the ID list screen.

- ⑥ Push [MENU] to return to the Main screen.

■ Entering the position and time

A Distress call should include the ship's position and time.

If no GPS data is received, you should manually enter your position (latitude and longitude) and Universal Time Coordinated (UTC) time.

When a GPS receiver compatible with the IEC61162-1: 2000 format is connected, position and UTC time are automatically included.

- Manual entry is disabled when a valid GPS data is received.
- Manually entered position and time are valid for only 23.5 hours.

- ① Push [MENU].
- ② Select "Position Input," then push [ENT].
(DSC Settings > **Position Input**)

- ③ Enter your latitude position.

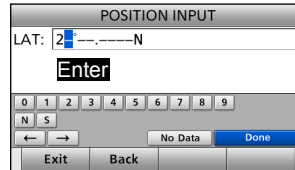

Push

1	2	3
4	5	6
7	8	9
10	0	20

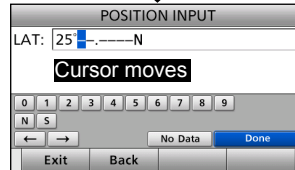

Rotate

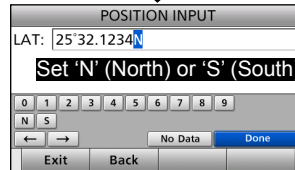

Push

1	2	3
4	5	6
7	8	9
10	0	20

 (any key)

- To select 'N' (North latitude) or 'S' (South latitude), push any keypad key when the cursor is on the 'N' or 'S' position.
- ④ After entering, push [ENT].

- ⑤ Enter your longitude position.

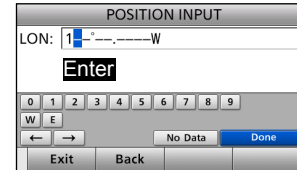

Push

1	2	3
4	5	6
7	8	9
10	0	20

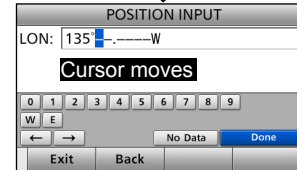

Rotate

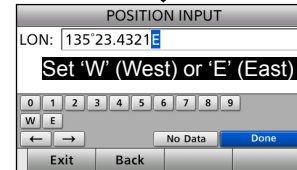

Push

1	2	3
4	5	6
7	8	9
10	0	20

 (any key)

- To select W (West longitude) or E (East longitude), push any keypad key when the cursor is on the 'W' or 'E' position.
- ⑥ After entering, push [ENT].

☞ Continued on the next page.

8 DSC OPERATION

■ Entering the position and time

⑦ Enter your UTC time.

Push
 1 2 3
 4 5 6
 7 8 9
 10 0 20

Rotate
 CH/ENT

Push
 1 2 3
 4 5 6
 7 8 9
 10 0 20
 (any key)

⑧ After entering, push [ENT].

- The DSC SETTINGS screen is displayed.

⑨ Push [MENU] to return to the Main screen.

When position and time data are set, Latitude, Longitude and UTC time are displayed.



- Latitude: 25°32.1234N
- Longitude: 135°23.4321E
- UTC time: 12:00

When no position and time data are set, “No Position” and “No Time” are displayed.

NOTE:

While entering:

- To move the cursor:
Rotate [CH/ENT].
- To correct the entry:
Move the cursor to the character. And then, enter the correct character.
- To clear the entry:
Push [▲], [▼], [◀], or [▶] to select “No Data.” And then push [ENT].
When the following screen is displayed, push [ENT].

- To return to the Main screen:
Push [Exit] .
- To go back to the previous screen:
Push [Back] .

■ DSC Task mode

After sending or receiving a DSC call, the transceiver enters the DSC Task mode.

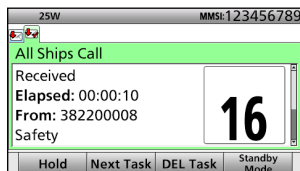

(Example: After receiving an All Ships call)

In the Task mode, you can resend the call, or send an acknowledgement to the caller station, and so on.

- The transceiver can hold up to 7 tasks.
- In the standby mode, a task icon is displayed in the Task area, when the transceiver has a DSC task.
- When any task icon is displayed in the standby mode, you can enter the Task mode by pushing [Task Mode] .

NOTE: The Task mode has a TOT (Time-out Timer) function. When you push no key for a preset period, the transceiver automatically exits the Task mode.

The count down alarm sounds 10 seconds before the TOT activates. No count down alarm sounds before Radio Telephone TOT activates. The default settings of the TOT function.

- Distress call: OFF
- Non-Distress call: 15 minutes

◇ About “Active” and “Hold”

The Task mode has two statuses, Active and Hold.

When you resend the call, or send an acknowledgement to a caller station, push [Active]  to enter the DSC Task mode.

• Active window

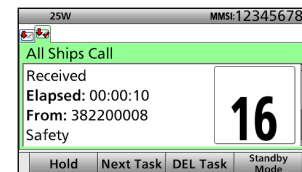

- “✓” is displayed on the active Task tab.
- To view the contents, rotate [CH/ENT].

• Hold window

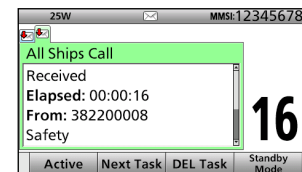

- To view the contents, push [▲] or [▼].

8 DSC OPERATION

■ DSC Task mode (Continued)

◇ Software key functions

When entering the Task mode, the following functions are displayed first.

FUNCTION	DESCRIPTION
Hold	Push to cancel the Active Task window.
Active	Push to activate the received call.
Next Task	Push to select other Task.
DEL Task	Push to delete the Task.
Standby Mode	Push to return to the Main screen.

The following functions may be displayed, depending on the call type.

FUNCTION	DESCRIPTION
Cancel	Push to send a Cancel call.
Resend	Push to resend the call.
Pause	Push to pause the 'Call repeat' mode, or pause the countdown.
Resume	Push to restart the countdown.
Finish	Push to return to the Main screen.
ACK	Push to send an acknowledgement.
History	Push to display the Distress call history screen.
Relay	Push to send a Distress Relay call.

See the following pages for details of the DSC Task mode operation of each DSC call.

The following functions are displayed, after receiving an Individual call.

FUNCTION	DESCRIPTION
ACK (Able)	Push to send an acknowledgment without any changes.
ACK (Unable)	Push to send an acknowledgment, but you cannot make a communication.
ACK (New CH)	Send an acknowledgment. You can specify the Voice Communication channel.

■ Sending a Distress call

NEVER MAKE A DISTRESS CALL IF YOUR SHIP OR A PERSON IS NOT IN AN EMERGENCY. A DISTRESS CALL SHOULD BE MADE ONLY WHEN IMMEDIATE HELP IS NEEDED.

You should send a Distress call if, in the opinion of the Master, the ship or a person is in distress and requires immediate assistance.

- Emergency channel (Channel 70) is automatically selected to send a Distress call.

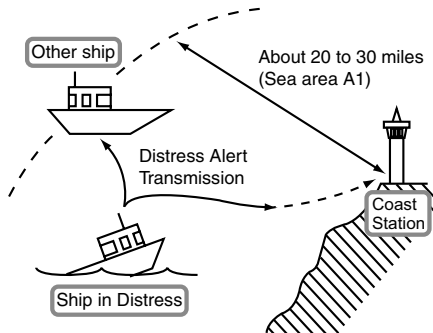

See **NOTE** on page 31 for a Distress call.

TIP: If you want to compose a Distress call, see 'Regular call.' (p. 30)

◇ Simple call

- ① Confirm no Distress call is being received.
- ② Lift up the key cover, then hold down [DISTRESS] until "Transmitting" is displayed to send the Distress call.
 - While holding down [DISTRESS], count down beeps sound and both the key and display backlighting blink.

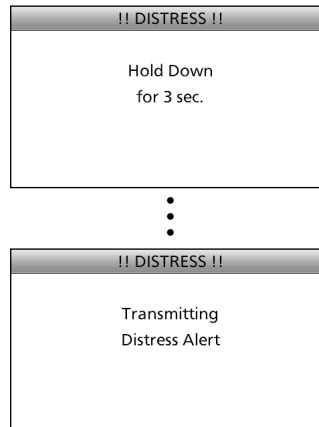



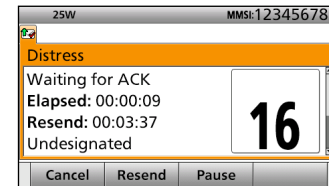

- ③ After sending, the following screen is displayed.

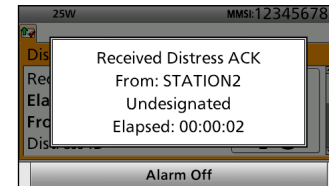

- Channel 16 is automatically selected.

- ④ When receiving the acknowledgement:
 - Alarm sounds.
 - The following screen is displayed.



- ⑤ Push any [Alarm Off] .
- ⑥ Push any [Close Call RCVD Window] .
- ⑦ Hold down [PTT] to announce your situation.
- ⑧ Push [Standby Mode]  to return to the Main screen.

8 DSC OPERATION

■ Sending a Distress call (Continued)

◇ Regular call

You can compose the Distress call.

Step 1. Display the COMPOSE DISTRESS screen

- ① Push [Compose Distress] 

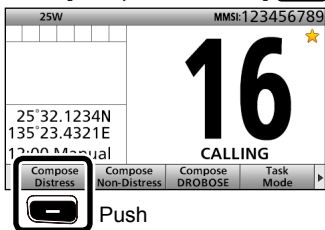

Push

- To display the screen from the Menu screen:
([MENU] > **Compose Distress**)

Step 2. Setting “Nature of Distress”

- ① Push [ENT].

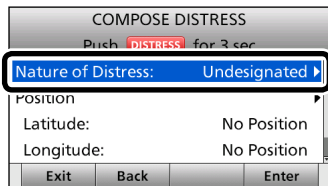

Push



- ② Select the desired option, then push [ENT].
(Example: Fire,Explosion)

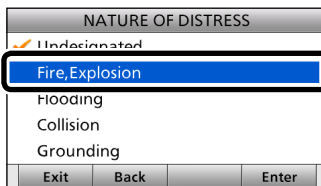

Options:

- Undesignated, Fire,Explosion, Flooding, Collision, Grounding, Capsizing, Sinking, Adrift, Abandoning Ship, Piracy, and Man Overboard.
- The transceiver stores this setting for 30 seconds.

You can skip Step 3 below if your position and time data are valid.
In that case, go to Step 4.

Step 3. Entering “Position”

- ① Select “Position,” then push [ENT].
 - The position entry screen is displayed.
- ② Enter your position and time data.
 - See page 25 for entering details.
- ③ After entering, push [ENT].

Step 4. Sending

- ① Lift up the key cover, then hold down [DISTRESS] until “Transmitting” is displayed to send the Distress call.
- While holding down [DISTRESS], count down beeps sound and both the key and display backlighting blink.

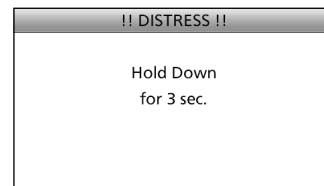

- ② After sending, the following screen is displayed.

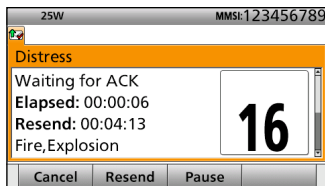



- Channel 16 is automatically selected.
- See page 28 for details of the Task mode's software key functions.

Step 5. Replying

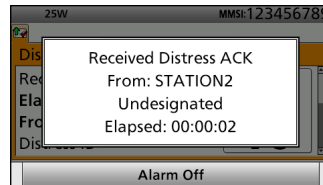
- ① When the acknowledgement is received:
- Alarm sounds.
 - The following screen is displayed.





- ② Push any [Alarm Off] .
- ③ Push any [Close Call RCVD Window] .
- ④ Hold down [PTT] to announce your situation.
- ⑤ Push [Standby Mode]  to return to the Main screen.

NOTE:

Transmitting:

- A distress alert default contains:
 - Nature of distress:
 - Undesignated distress (Simple call)
 - Selected in Step 2 (Regular call)
 - Position information:
 - The latest GPS or manual input position is held for 23.5 hours, or until the power is turned OFF.

Waiting for an acknowledgement:

- The transceiver automatically sends a Distress call every 3.5 to 4.5 minutes, until receiving an acknowledgement ('Call repeat' mode), or sending a DSC Cancel call. (p. 33)
- To manually send a Distress Repeat call: Push [Resend] .
- To view the call contents: Rotate [CH/ENT].
- To pause the 'Call repeat' mode: Push [Pause] . To resume it: Push [Resume Countdown] .

8 DSC OPERATION

■ Distress call (Continued)

◇ Resending a Distress call

While waiting for an acknowledgement, you can resend the call. (Repeat call)

- ① When “Waiting for ACK” is displayed, push [Resend] .

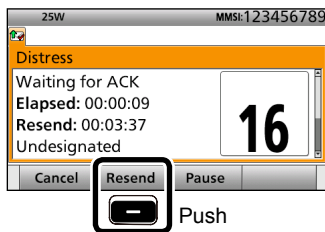



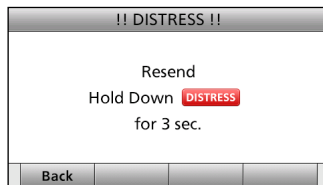

- See page 28 for details of the Task mode's software key functions.

- ② Lift up the key cover, then hold down [DISTRESS] until “Retransmitting” is displayed to resend the call.
- While holding down [DISTRESS], count down beeps sound and both the key and display backlighting blink.

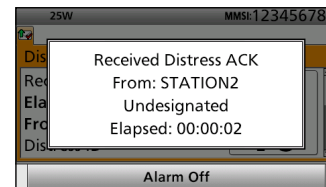

- ③ When the acknowledgement is received:
- Alarm sounds.
 - The following screen is displayed.



- ④ Push any [Alarm Off] .
- ⑤ Push any [Close Call RCVD Window] .
- ⑥ Hold down [PTT] to announce your situation.
- ⑦ Push [Standby Mode]  to return to the Main screen.

◇ Sending a Distress Cancel call

While waiting for an acknowledgement, you can send a Distress Cancel call.

- ① When "Waiting for ACK" is displayed, push [Cancel] .

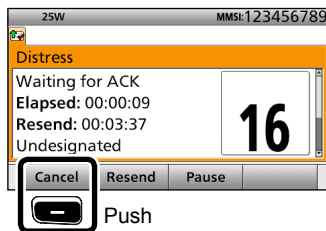

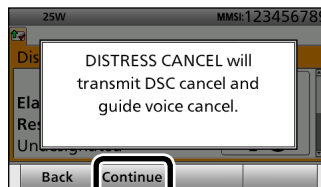

• See page 28 for details of the Task mode's software key functions.

- ② Push [Continue]  to send a Distress Cancel call.

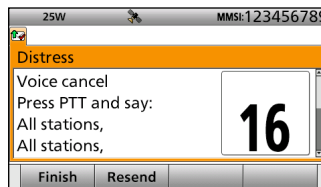

- ③ After sending, the following screen is displayed.



- ④ Hold down [PTT] to announce your cancel statement.
 - Rotate [CH/ENT] to view the cancel statement of the Distress Cancel call.
- ⑤ Select your desired action.
 - [Finish]: Finishes the Distress Cancel procedures.
 - [Resend]: Sends a Distress Cancel call again.
- ⑥ Push [Standby Mode]  to return to the Main screen.

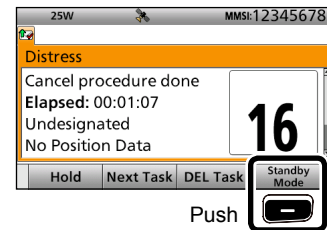

8 DSC OPERATION

■ Distress call (Continued)

◇ Sending a Distress acknowledgement



Distress call reception should stop after one sequence because the coast station should send back an 'acknowledgement' to the ship.

If the Distress call continues even after the coast station sends back an 'acknowledgement,' the ship in distress may not be receiving the acknowledgement.

In such cases, you should send back an 'acknowledgement' instead of the coast station and contact the coast station.

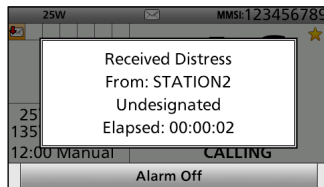
- ① When a Distress call is received:
 - Alarm sounds.
 - The following screen is displayed.



- ② Push any [Alarm Off] .
- ③ Push [Accept] .

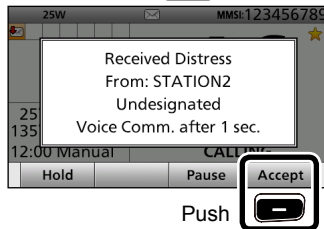

- Enters the DSC Task mode.
- ④ Push [▶] to scroll the software key functions.

- ⑤ Push [ACK (Distress)] .



- ⑥ Push [OK] .

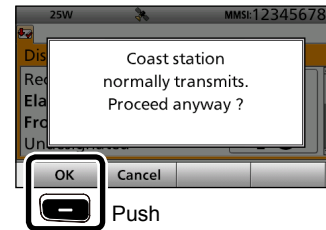



- The call contents screen is displayed.
- Rotate [CH/ENT] to view the call contents.

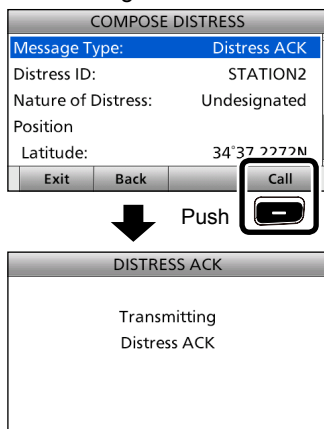

- ⑦ Push [Call]  to send a Distress acknowledgement.

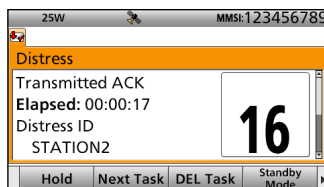

- ⑧ After sending, the following screen is displayed.



- ⑨ Hold down [PTT] to communicate with the ship in distress.
 ⑩ Push [Standby Mode]  to return to the Main screen.

TIP: When you push [Pause]  in step 3, the countdown will be paused. Push [Resume]  to restart the countdown.

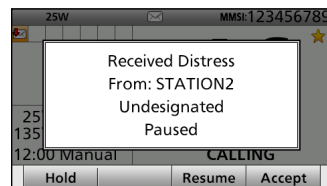

8 DSC OPERATION

■ Distress call

◇ Sending a Distress Relay call

There are two ways to transmit the Distress Relay call—“Distress Relay On Behalf Of Someone Else (DROBOSE)” and “Distress Relay Call with Distress Call Log”.

NOTE: DO NOT push [DISTRESS] to transmit a Distress Relay call. You should use it for only your own ship’s Distress call.

To transmit the Distress Relay call with “DROBOSE”:

You may transmit a Distress Relay call when a ship in distress cannot successfully send a Distress call, or when you find a ship in distress and it requires your immediate help.

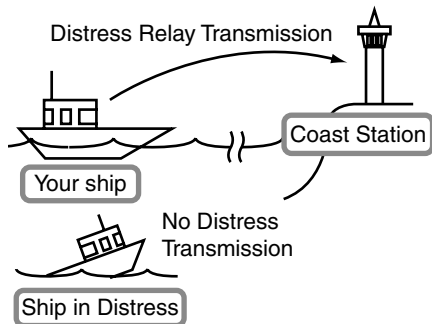

- ① Push [Compose DROBOSE]  to display the COMPOSE DROBOSE screen.

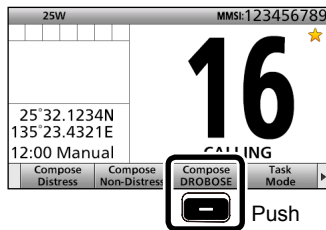

• To display the screen from the Menu screen:

([MENU] > **Compose DROBOSE**)

- ② Select “Message Type,” then push [ENT].
- ③ Select the desired message type, then push [ENT].
(Example: Individual)

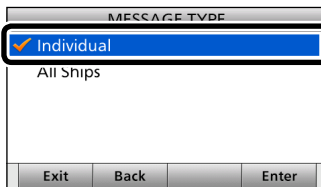

Rotate
CH/ENT
+
Push
ENT

When you select “All Ships” in step ③, “Address” is not displayed in step ④. In that case, go to step ⑥.

- ④ Select “Address,” then push [ENT].
- ⑤ Select the desired coast station address or “Manual Input,” then push [ENT].
(Example: STATION1)

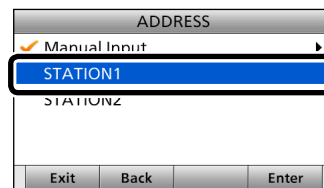

Rotate
CH/ENT
+
Push
ENT

When you select “Manual Input” in step ⑤, push the keypad to manually enter the desired Individual ID. (p. 23)

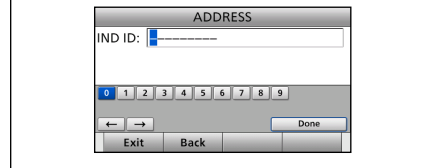

- ⑥ Select “Distress ID,” then push [ENT].

- ⑦ Select “Manual Input,” then push [ENT].

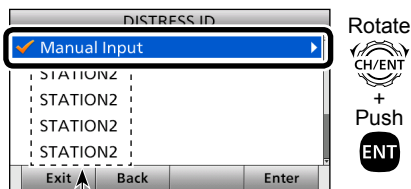

The Distress Call Log is displayed after receiving the Distress call. **DO NOT** select an ID for DROBOSE.

- ⑧ Enter the 9 digit Distress ID (MMSI ID) code of the ship in distress that you wish to help.

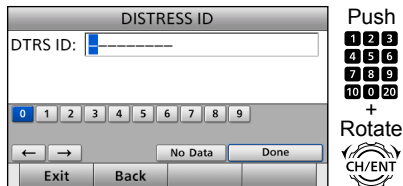

If you do not know the Distress ID, you can skip step ⑧, and go to step ⑨.

- ⑨ After entering, push [ENT].
 ⑩ Select “Nature of Distress,” then push [ENT].
 ⑪ Select the desired option, then push [ENT].
 (Example: Fire,Explosion)

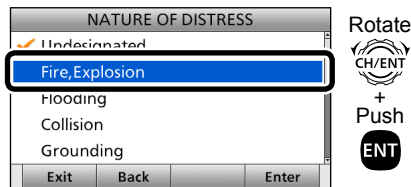

Options:

Undesignated, Fire,Explosion, Flooding, Collision, Grounding, Capsizing, Sinking, Adrift, Abandoning Ship, Piracy, Man Overboard and EPIRB Emission.
 • The transceiver holds this setting for 30 seconds.

- ⑫ Select “Position,” then push [ENT].

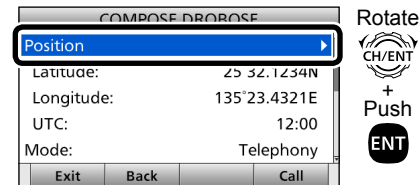

- The position entry screen is displayed.
 - Your position and time are displayed.
- ⑬ Enter the position and time data of the ship in distress.
 • See page 25 for entering details.

- ⑭ After entering, push [ENT].

8 DSC OPERATION

■ Distress call

◇ Sending a Distress Relay call (Continued)

- ⑮ Push [Call]  to send the Distress Relay call.

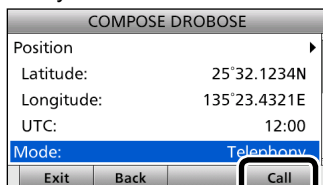

Push

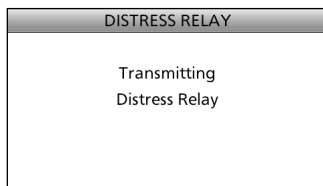

- ⑯ After sending, the following screen is displayed.

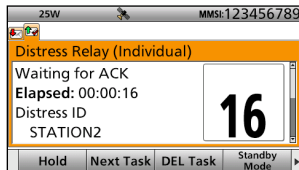



- See page 28 for details of the Task mode's software key functions.

- ⑰ When the acknowledgement is received:

- Alarm sounds.
- The following screen is displayed.



- ⑱ Push any [Alarm Off] .
- ⑲ Push any [Close Call RCVD Window] .
- ⑳ Hold down [PTT] to communicate.
- ㉑ Push [Standby Mode]  to return to the Main screen.

To transmit the distress relay call with “Distress Call Log”:

You can relay a Distress call after receiving it.

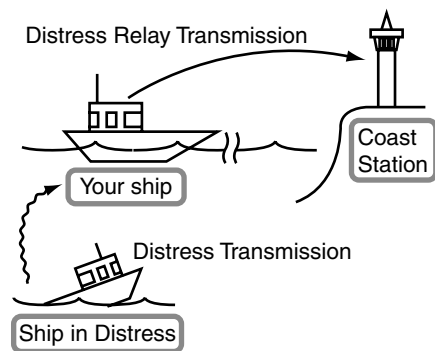

- ① Push [Compose DROBOSE]  to display the COMPOSE DROBOSE screen.
 - To display the screen from the Menu screen: ([MENU] > **Compose DROBOSE**)
- ② Select “Message Type,” then push [ENT].

- ③ Select the desired message type. (Example: Individual)

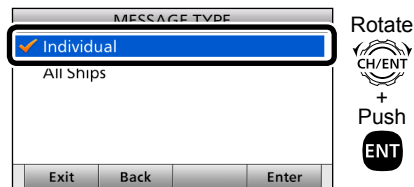

When you select “All Ships” in step ③, “Address” is not displayed in step ④. In that case, go to step ⑥.

- ④ Select “Address,” then push [ENT].
- ⑤ Select the desired coast station address or “Manual Input,” then push [ENT]. (Example: STATION1)

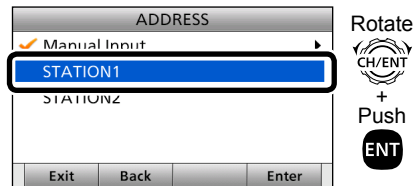

When you select “Manual Input” in step ⑤, push the keypad to manually enter the desired Individual ID. (p. 23)

A screenshot of the 'ADDRESS' menu. The title is 'ADDRESS'. Below the title is a field labeled 'IND ID:'. Below the field is a numeric keypad with digits 0-9 and a 'Done' button. At the bottom, there are three buttons: 'Exit', 'Back', and 'Done'.

- ⑥ Select “Distress ID,” then push [ENT].
- ⑦ Select the required Distress ID from the Call log list, then push [ENT].

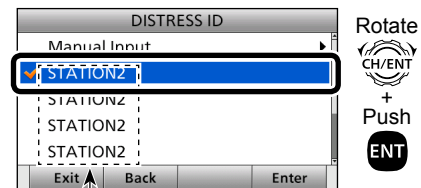

Distress Call Log is displayed after receiving the Distress Call.

8 DSC OPERATION

■ Distress call

◇ Sending a Distress Relay call (Continued)

- ⑧ Push [Call]  to send the Distress Relay call.

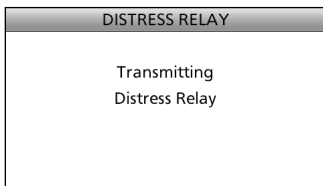
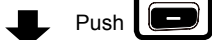
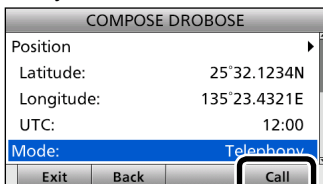

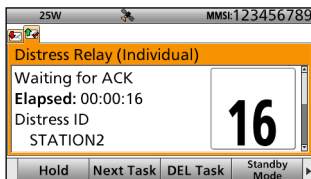

- ⑨ After sending, the following screen is displayed.



- See page 28 for details of the Task mode's software key functions.
- ⑩ When the acknowledgement is received:
- Alarm sounds.
 - The following screen is displayed.





- ⑪ Push any [Alarm Off] .
- ⑫ Push any [Close Call RCVD Window] .
- ⑬ Hold down [PTT] to communicate.
- ⑭ Push [Standby Mode]  to return to the Main screen.

◇ Sending a Distress Relay acknowledgement

You can send the Distress Relay acknowledgment only when the Distress Relay call is received.

- ① When a Distress Relay call is received:
 - Alarm sounds.
 - The following screen is displayed.



- ② Push any [Alarm Off] .
- ③ Push [Accept] .
 - Enters the DSC Task mode.
- ④ Push [▶] to scroll the software key functions.

- ⑤ Push [ACK (Relay)] .

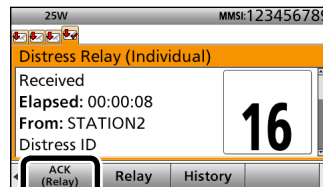

 Push

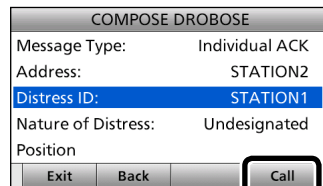

- The call contents screen is displayed.
- Rotate [CH/ENT] to view the call contents.

- ⑥ Push [Call]  to send the Distress Relay acknowledgement.



Push 

- ⑦ Hold down [PTT] to communicate.
- ⑧ Push [Standby Mode]  to return to the Main screen.

TIP: When you push [Pause]  in step 3, the countdown will be paused. Push [Resume]  to restart the countdown.

■ Sending a Non-Distress call

To ensure correct operation of the DSC function, confirm you correctly set the Channel 70 squelch level. (p. 74)

NOTE:

- Emergency channel (Channel 70) is automatically selected for calling.
- If Channel 70 is busy, the transceiver stands by until the channel becomes clear.

◇ Sending an Individual call

The Individual call function enables you to transmit a DSC signal to only a specific coast station or ship. After transmission, wait for an acknowledgement from the receiving station.

You can communicate by voice after receiving the acknowledgement 'ACK (Able).'

- ① Push [Compose Non-Distress]  to display the COMPOSE NON-DISTRESS screen.

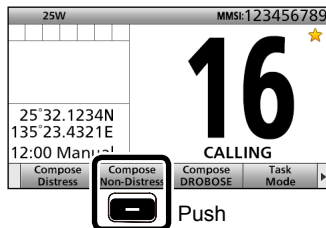

- To display the screen from the Menu screen:
([MENU] > **Compose Non-Distress**)

- ② Push [ENT].

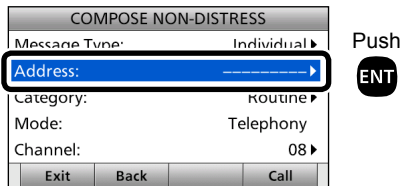

- ③ Select the desired individual address, or "Manual Input," then push [ENT].
(Example: STATION1)

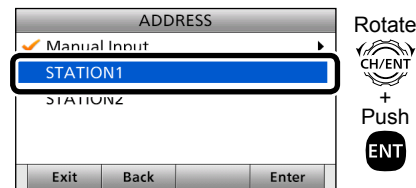

- When you select "Manual Input" in step ③, push the keypad to manually enter the desired Individual ID. (p. 23)

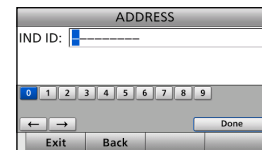

- ④ Select “Category,” then push [ENT].
- ⑤ Select the desired option, then push [ENT].

(Example: Routine)

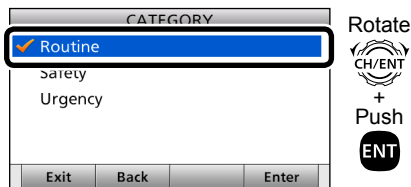

When you select a coast station in step ③, the voice channel is automatically specified by the coast station. Therefore, skip steps ⑥ and ⑦, and go to step ⑧.

- ⑥ Select “Channel,” then push [ENT].
- ⑦ Select the desired voice channel, then push [ENT].

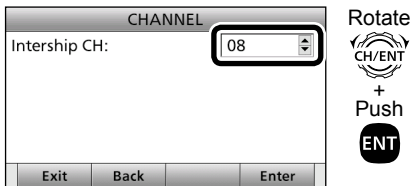

- ⑧ Push [Call]  to send the Individual call.

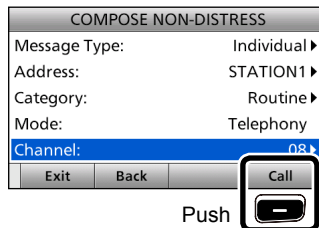

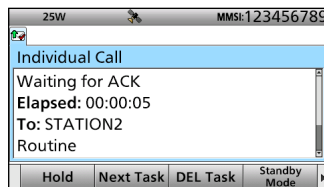

- ⑨ After sending, the following screen is displayed.

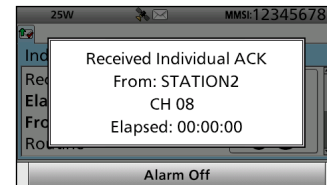

- See page 28 for details of the Task mode's software key functions.

- ⑩ When the acknowledgement is received:
 - Alarm sounds.
 - The following screen is displayed.
 (Example: ACK (Able))



- ⑪ Push any [Alarm Off] .
- ⑫ Push any [Close Call RCVD Window] .

When you receive “ACK (Unable)” in step ⑩, skip step ⑬, and go to step ⑭.

- ⑬ Hold down [PTT] to communicate.
- ⑭ Push [Standby Mode]  to return to the Main screen.

NOTE:

After receiving the acknowledgement:

- The voice channel specified in step ⑦ is selected.
- A different voice channel is selected if the station you called cannot use the channel.

8 DSC OPERATION



■ Sending a Non-Distress calls (Continued)

◇ Sending an Individual acknowledgement

When receiving an Individual call, you can send an acknowledgement ('Able,' 'Unable,' or 'New CH') by using the on-screen prompts.

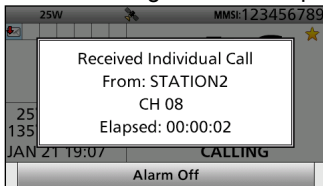
- ① When an Individual call is received:
 - Alarm sounds.
 - The following screen is displayed.



- ② Push any [Alarm Off] .
- ③ Push [Accept] .

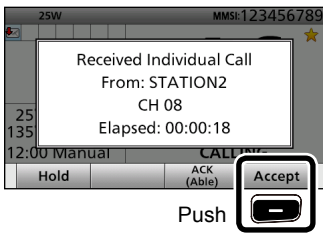

Push

- Enters the DSC Task mode.

- ④ Push  to scroll the software key functions.
- ⑤ Select your desired action.

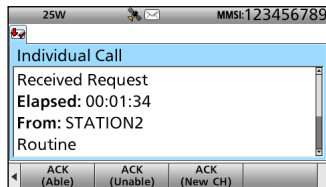

[ACK (Able)]:

Sends an acknowledgment without any changes.

[ACK (Unable)]:

Sends an acknowledgment, but you cannot make a communication.

[ACK (New CH)]:

Sends an acknowledgment. You can specify the Voice Communication channel.

- ⑥ Push [Call]  to send the Individual acknowledgement.

When you push [ACK (Unable)] in step ⑤, skip step ⑦, and go to step ⑧.

- ⑦ Hold down [PTT] to communicate.
- ⑧ Push [Standby Mode]  to return to the Main screen.

◇ Sending an All Ships call

All ships, that have DSC transceiver, use Channel 70 as their 'listening channel.' When you want to announce a message to these ships within range, use the 'All Ships Call' function.

- 1 Push [Compose Non-Distress]  to display the COMPOSE NON-DISTRESS screen.

- To display the screen from the Menu screen:

([MENU] > **Compose Non-Distress**)

- 2 Select "Message Type," then push [ENT].
- 3 Select "All Ships," then push [ENT].

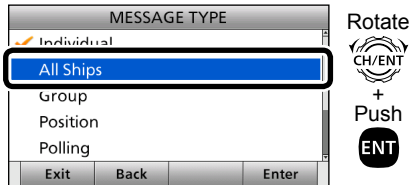

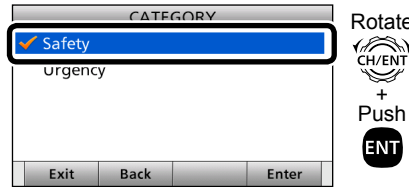

- 4 Select "Category," then push [ENT].

- 5 Select the desired option, then push [ENT].
(Example: Safety)

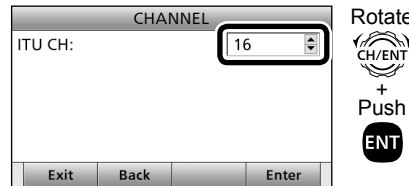

- 6 Select "Channel," then push [ENT].
- 7 Select the desired voice channel, then push [ENT].



- 8 Push [Call]  to send the All ships call.

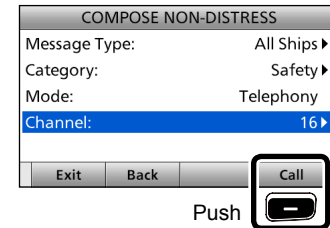

- 9 After sending, the following screen is displayed.

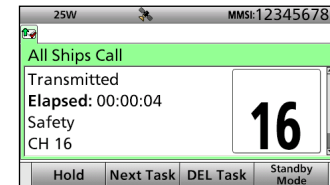

- See page 28 for details of the Task mode's software key functions.

- 10 Hold down [PTT] to announce the message.
- 11 Push [Standby Mode]  to return to the Main screen.

8 DSC OPERATION

■ Sending a Non-Distress calls

◇ Sending a Group call

The Group call function allows you to transmit a DSC signal to only a specific group.

- ① Push [Compose Non-Distress]  to display the COMPOSE NON-DISTRESS screen.

• To display the screen from the Menu screen:
([MENU] > **Compose Non-Distress**)

- ② Select "Message Type," then push [ENT].
- ③ Select "Group," then push [ENT].

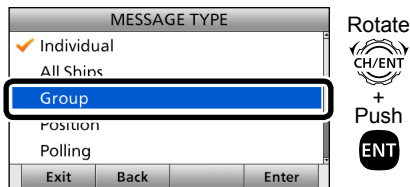

- ④ Select "Address," then push [ENT].
- ⑤ Select the desired Group address or "Manual Input," then push [ENT].
(Example: GROUP1)

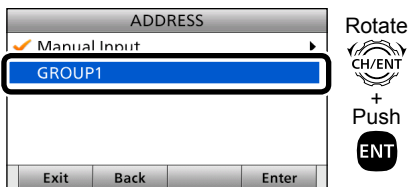

When you select "Manual Input" in step ⑤, push the keypad to manually enter the desired Group ID. (p. 24)

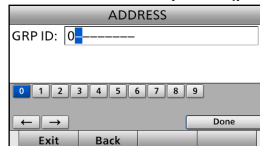

- ⑥ Select "Channel," then push [ENT].
- ⑦ Select the desired voice channel, then push [ENT].

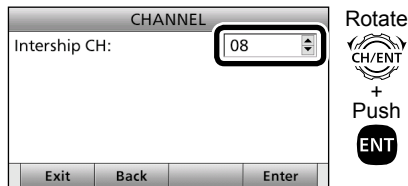

- ⑧ Push [Call]  to send the Group call.

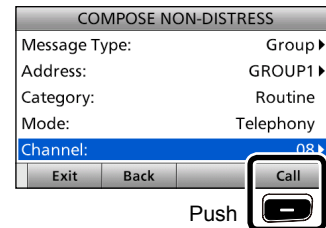

- ⑨ After sending, the following screen is displayed.

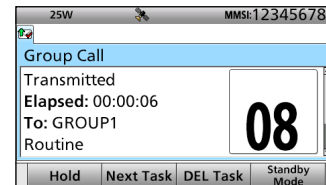

- See page 28 for details of the Task mode's software key functions.
- ⑩ Hold down [PTT] to announce the message.
 - ⑪ Push [Standby Mode]  to return to the Main screen.

◇ Sending a Position Request call

Transmit a Position Request call when you want to know a specific ship's current position, and so on.

- ① Push [Compose Non-Distress]  to display the COMPOSE NON-DISTRESS screen.
- To display the screen from the Menu screen:
- ([MENU] > **Compose Non-Distress**)
- ② Select "Message Type," then push [ENT].
- ③ Select "Position," then push [ENT].

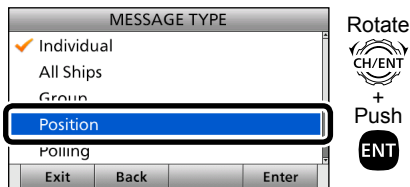

- ④ Select "Address," then push [ENT].
- ⑤ Select the desired individual address, or "Manual Input," then push [ENT].
(Example: STATION1)

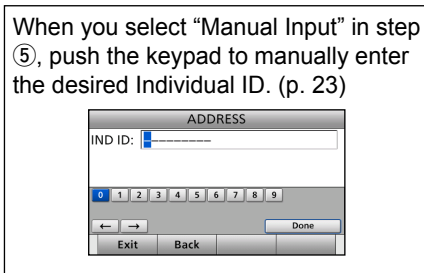
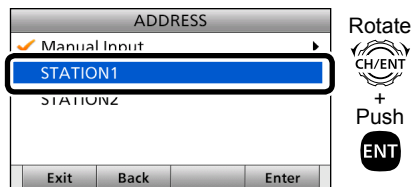

- ⑥ Push [Call]  to send the Position Request call.

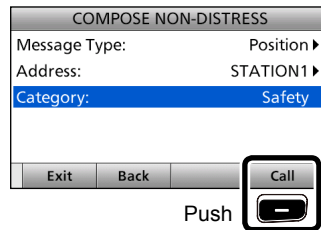



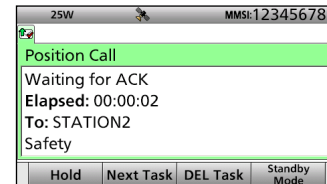

- ⑦ After sending, the following screen is displayed.

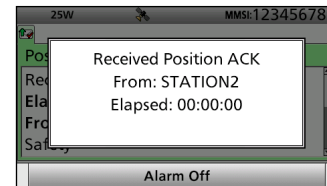

- See page 28 for details of the Task mode's software key functions.

- ⑧ When the acknowledgement is received:
- Alarm sounds.
- The following screen is displayed.



- ⑨ Push any [Alarm Off] .
- ⑩ Push any [Close Call RCVD Window] .
- Rotate [CH/ENT] to view the call contents (position data is included).
- ⑪ Push [Standby Mode]  to return to the Main screen.

8 DSC OPERATION

■ Sending a Non-Distress calls (Continued)



◇ Sending a Position Request acknowledgement

When a Position Request call is received, you can send an acknowledgement.

① When a Position Request call is received:

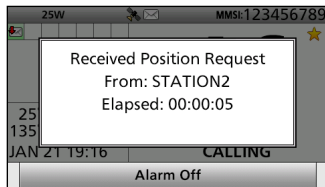
- Alarm sounds.
- The following screen is displayed.



- ② Push any [Alarm Off] .
- ③ Push [Accept] 
 - Enters the DSC Task mode.
- ④ Push  to scroll the software key functions.

⑤ Select your desired action.

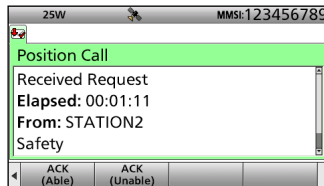



[ACK (Able)]:

Sends an acknowledgment with position and time data.

[ACK (Unable)]:

Sends an acknowledgment with no position and time data.

- The call contents screen is displayed.
 - Rotate [CH/ENT] to view the call contents.
 - Change your position data, if the displayed data is invalid. (p. 25)
- ⑥ Push [Call]  to send the acknowledgement.
 - When [ACK (Able)] is selected in step ⑤, your position and time data are transmitted.
 - ⑦ Push [Standby Mode]  to return to the Main screen.



TIP: When "Position ACK" is set to Auto, the transceiver automatically sends the acknowledgement. (p. 71)

◇ Sending a Polling Request acknowledgement

When a Polling Request call is received, you can send an acknowledgement. A Polling Request call enables the calling station to know a specific ship is within communication range, or not.

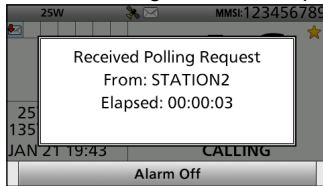

- ① When a Polling Request is received:
 - Alarm sounds.
 - The following screen is displayed.

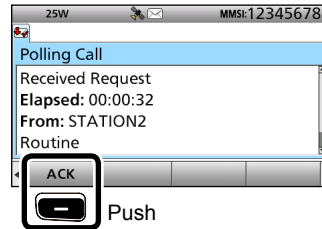

- ② Push any [Alarm Off] .
- ③ Push [Accept] .
 - Enters the DSC Task mode.
- ④ Push [▶] to scroll the software key functions.

- ⑤ Push [ACK] .



- The call contents screen is displayed.
 - Rotate [CH/ENT] to view the call contents.
- ⑥ Push [Call]  to send the acknowledgement.
 - ⑦ Push [Standby Mode]  to return to the Main screen.

TIP: When "Polling ACK" is set to "Auto," the transceiver automatically sends the acknowledgement. (p. 71)

8 DSC OPERATION

■ Sending a Non-Distress calls (Continued)

◇ Sending a Test call

Testing on the exclusive DSC distress and safety calling channels should be avoided as much as possible by using other methods.

Normally the test call would require no further communications between the two stations involved.

- 1 Push [Compose Non-Distress]  to display the COMPOSE NON-DISTRESS screen.

- To display the screen from the Menu screen:
([MENU] > **Compose Non-Distress**)

- 2 Select "Message Type," then push [ENT].
- 3 Select "Test."

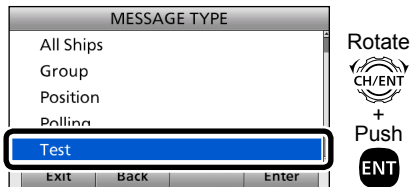

- 4 Select "Address," then push [ENT].

- 5 Select the desired Individual address, or "Manual Input." (Example: STATION1)

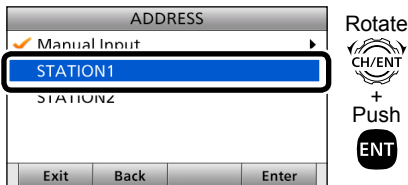

When you select "Manual Input" in step 5, push the keypad to manually enter the desired Individual ID. (p. 23)

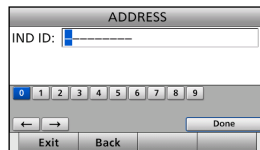

- 6 Push [Call]  to send the Test call.

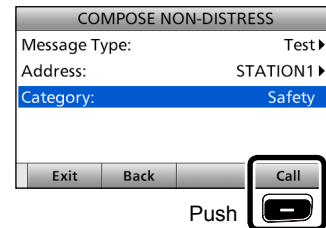



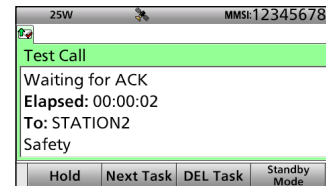

- 7 After sending, the following screen is displayed.

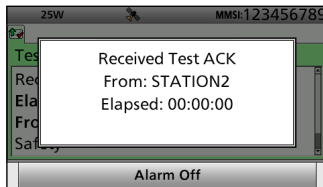

- See page 28 for details of the Task mode's software key functions.



- ⑧ When the acknowledgement is received:
 - Alarm sounds.
 - The following screen is displayed.



- ⑨ Push any [Alarm Off] .
- ⑩ Push [Accept] .
 - Enters the DSC Task mode.
- ⑪ Rotate [CH/ENT] to view the received message log.
- ⑫ Push [Standby Mode]  to return to the Main screen.

◆ Sending a Test call acknowledgement

When a Test call is received, you can send an acknowledgement.

- ① When a Test call is received:
 - Alarm sounds.
- ② Push any [Alarm Off] .
- ③ Push [Accept] .

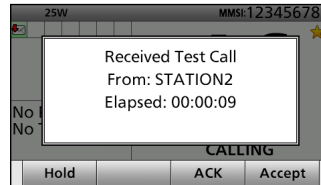

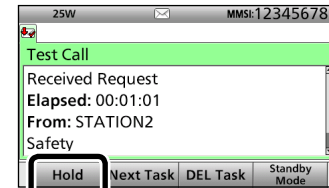

- Enters the DSC Task mode.
- ④ Push [▶] to scroll the software key functions.

- ⑤ Push [ACK] .



 Push

- The call contents screen is displayed.
- Rotate [CH/ENT] to view the call contents.
- ⑥ Push [Call]  to send the acknowledgement.
- ⑦ Push [Standby Mode]  to return to the Main screen.

TIP: When “Test ACK” is set to “Auto,” the transceiver automatically sends the acknowledgement. (p. 71)

8 DSC OPERATION

■ Sending a Non-Distress calls (Continued)

◇ Sending a Medical Transports call

The Medical Transports call informs all ships, by urgency priority, that your ship is carrying a patient in need of medical treatment.

NOTE: You should set the “Medical Transports” item to ON in advance. (p. 72)

- 1 Push [Compose Non-Distress]  to display the COMPOSE NON-DISTRESS screen.
 - To display the screen from the Menu screen:
([MENU] > **Compose Non-Distress**)
- 2 Select “Message Type,” then push [ENT].
- 3 Select “Medical Transports,” then push [ENT].

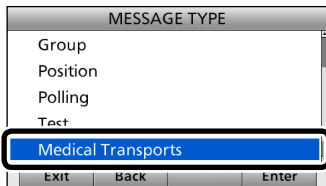

- 4 Select “Channel,” then push [ENT].
- 5 Select the desired traffic channel, then push [ENT].

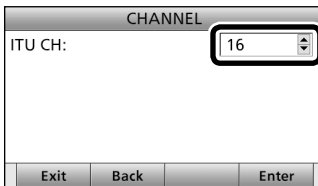

- 6 Push [Call]  to send the Medical Transports call.



Push



- 7 After sending, the following screen is displayed.

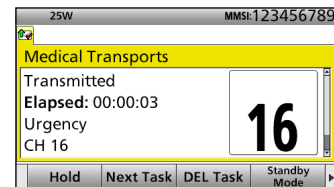

- See page 28 for details of the Task mode's software key functions.
 - Rotate [CH/ENT] to view the call contents.
- 8 Push [Standby Mode] to return to the Main screen.

◇ Sending a Ships and Aircraft call

The Ships and Aircraft call informs all ships that your ship is a neutral (not a participant) in armed conflict. Be sure to send the call **BEFORE** entering an area of armed conflict.

NOTE: You should set the “Ships and Aircraft” item to ON in advance. (p. 72)

- ① Push [Compose Non-Distress]  to display the COMPOSE NON-DISTRESS screen.
 - To display the screen from the Menu screen: ([MENU] > **Compose Non-Distress**)
- ② Select “Message Type,” then push [ENT].
- ③ Select “Ships and Aircraft,” then push [ENT].

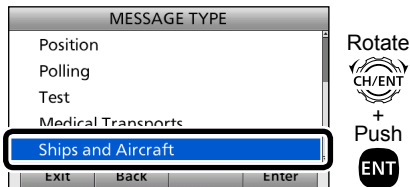

- ④ Select “Channel,” then push [ENT].
- ⑤ Select the desired traffic channel, then push [ENT].

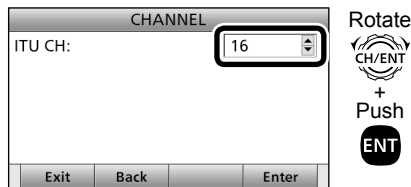

- ⑥ Push [Call]  to send the Ships and Aircraft call.

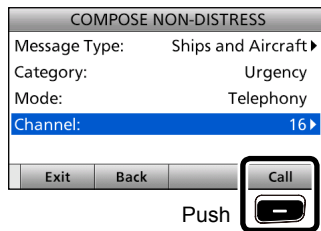

- ⑦ After sending, the following screen is displayed.

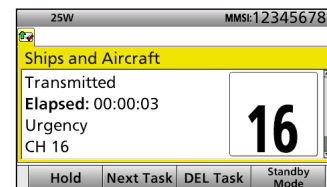

- See page 28 for details of the Task mode's software key functions.
 - Rotate [CH/ENT] to view the call contents.
- ⑧ Push [Standby Mode]  to return to the Main screen.

■ Receiving DSC calls

NOTE: After receiving a DSC call

- “

◇ Receiving a Distress Call

IMPORTANT!

Distress call reception should stop after one sequence because the coast station should send back an ‘acknowledgement’ to the ship. If the distress call continues, even after the coast station sends back an ‘acknowledgement,’ the ship in distress may not receive the acknowledgement. In such cases, you should send back an ‘acknowledgement’ instead of the coast station and contact the coast station. (p. 34)

- ① When a Distress call is received:
 - Alarm sounds.
 - The following screen is displayed and the backlight blinks.
 - “

- ② Push any [Alarm Off] .
- ③ Select your desired action.

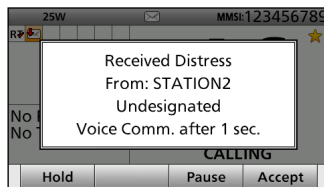

[Hold]: Holds the RX call task, and return to the previous screen.

[Pause]: Pauses the countdown.
 • To restart the countdown, push [Resume] .

[Accept]: Enters the DSC Task mode. To send the acknowledgement, push [Accept] .

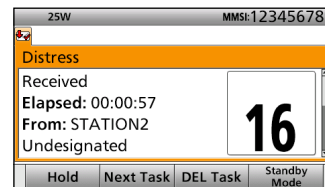

DSC Task mode

- Automatically selects Channel 16, and then you should monitor it, because a coast station may require assistance.
- Rotate [CH/ENT] to view the call contents.
- See page 28 for details of the Task mode’s software key functions.

When you select [Accept] in step ③, you can send the Relay call in the DSC Task mode. To send the Relay call, go to step ④. If you return to the Main screen without sending the Relay call, go to step ⑩.

- ④ Push [▶] to scroll the software key functions.

⑤ Push [Relay].



Push

⑥ When the confirmation screen is displayed, push [OK].

⑦ Select "Address," then push [ENT].

⑧ Select the desired Individual address, or "Manual Input," then push [ENT].

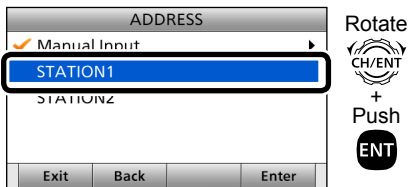

⑨ Push [Call] to send the Relay call.

⑩ Push [Standby Mode]  to return to the Main screen.

TIP: See page 34 for details of sending an acknowledgement.

◇ Receiving a Distress acknowledgement

① When a Distress acknowledgement sent to another ship is received:

- Alarm sounds.
- The following screen is displayed and the backlight blinks.
-  is displayed.

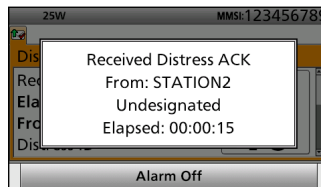

② Push any [Alarm Off] .

③ Push any [Close Call RCVD Window] .

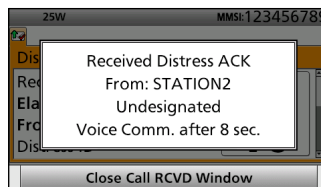

• Enters the DSC Task mode.

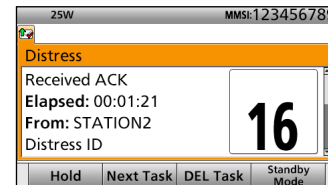



DSC Task mode

- Automatically selects Channel 16, and then monitor it, because a coast station may require assistance.
 - Rotate [CH/ENT] to view the call contents.
 - See page 28 for details of the Task mode's software key functions.
- ④ Push [Standby Mode]  to return to the Main screen.

8 DSC OPERATION

■ Receiving DSC calls (Continued)

◇ Receiving a Distress Cancel call

- ① When a Distress Cancel call is received:
 - Alarm sounds.
 - The following screen is displayed and the backlight blinks.
 - “” is displayed and “” blinks.

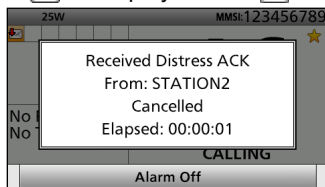

- ② Push any [Alarm Off] .
- ③ Select your desired action.

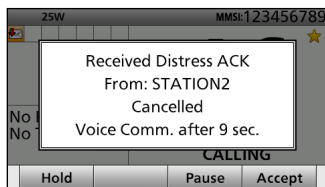

[Hold]: Holds the RX call task, and return to the previous screen.

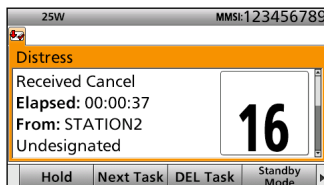

- [Pause]: Pauses the countdown.
 - To restart the countdown, push [Resume] .
- [Accept]: Enters the DSC Task mode.





DSC Task mode

- Automatically selects Channel 16, and then you should monitor it, because a coast station may require assistance.
 - Rotate [CH/ENT] to view the call contents.
 - See page 28 for details of the Task mode's software key functions.
- ④ Push [Standby Mode]  to return to the Main screen.

◇ Receiving a Distress Relay call

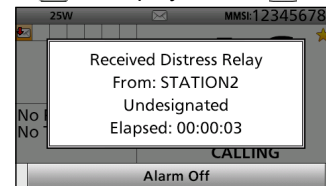
- ① When a Distress Relay call is received:
 - Alarm sounds.
 - The following screen is displayed and the backlight blinks.
 - “” is displayed and “” blinks.



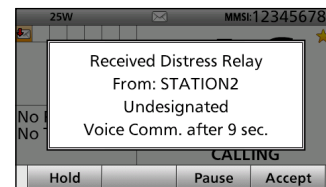

- ② Push any [Alarm Off] .
- ③ Select your desired action.



[Hold]: Holds the RX call task, and return to the previous screen.

[Pause]: Pauses the countdown.

- To restart the countdown, push [Resume] .

[Accept]: Enters the DSC Task mode.
To send the acknowledgement, push [Accept] .

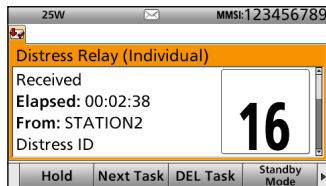

DSC Task mode



- Automatically selects Channel 16, and then monitor it, because a coast station may require assistance.
 - Rotate [CH/ENT] to view the call contents.
 - See page 28 for details of the Task mode's software key functions.
- ④ Push [Standby Mode]  to return to the Main screen.

TIP: See page 41 for details of sending acknowledgement.

◇ **Receiving a Distress Relay acknowledgement**

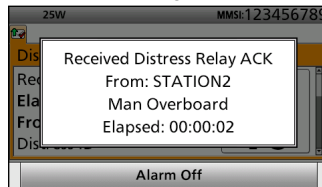
- ① When a Distress Relay acknowledgement is received:
- Alarm sounds.
 -  is displayed.
 - The following screen is displayed and the backlight blinks.



- ② Push any [Alarm Off] .
- ③ Push any [Close Call RCVD Window] .

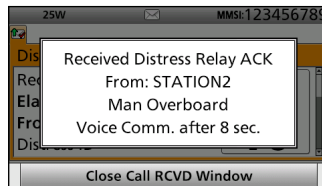

- Enters the DSC Task mode.

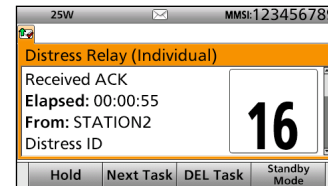

DSC Task mode



- Automatically selects Channel 16, and then you should monitor it, because a coast station may require assistance.
 - [PTT] is activated for voice communication via Channel 16.
 - Rotate [CH/ENT] to view the call contents.
 - See page 28 for details of the Task mode's software key functions.
- ④ Push [Standby Mode]  to return to the Main screen.

8 DSC OPERATION

■ Receiving DSC calls (Continued)

◇ Receiving an Individual call

NOTE: When the “Individual ACK” item is set to “Auto,” the transceiver automatically sends an acknowledgement. Both the TX and RX calls are stored in the Transmitted and Received Call Logs. (pp. 69, 70)

- ① When an Individual call is received:
 - Alarm sounds.
 - The following screen is displayed and the backlight blinks.
 -  is displayed and  blinks.

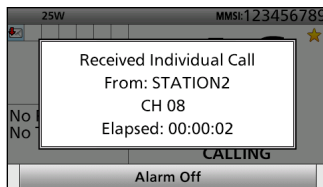

- ② Push any [Alarm Off] .
- ③ Select your desired action.

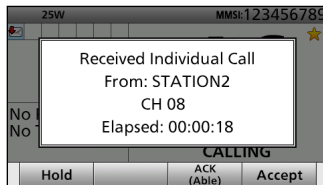

[Hold]: Holds the RX call task, and return to the previous screen.

[ACK (Able)]: Sends an acknowledgement without any changes.

[Accept]: Enters the DSC Task mode. To send the acknowledgement, push [Accept] .

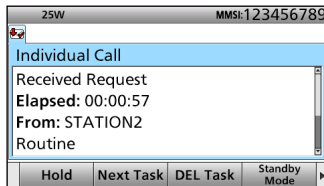



DSC Task mode

- Rotate [CH/ENT] to view the call contents.
- See page 28 for details of the Task mode's software key functions.

When you select [Accept] in step ③, you can send an acknowledgement in the DSC Task mode. To send the acknowledgement, go to step ④. If you return to the Main screen without sending the acknowledgement, go to step ⑧.

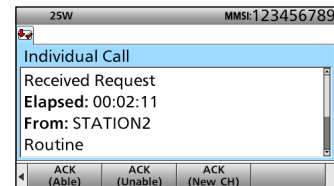
- ④ Push  to scroll the software key functions.



- ⑤ Push the desired key to select an acknowledgement option.
- ⑥ Push [Call]  to send the Individual acknowledgement.
- ⑦ Depending on the option selected in step ⑤, hold down [PTT] to communicate.
- ⑧ Push [Standby Mode]  to return to the Main screen.

TIP: When you send the acknowledgement, select one of three options, depending on your situation. See page 44 for details of the Individual acknowledgement procedures.

◇ Receiving an Individual acknowledgement

When receiving “ACK (Able)”:

You can make voice communication on the channel that you specified when you sent the call.

- When an Individual acknowledgement “ACK (Able)” is received:
 - Alarm sounds.
 - The following screen is displayed and the backlight blinks.
 - “

- Push any [Alarm Off] .

- Push any [Close Call RCVD Window] .

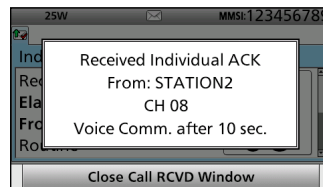

- Enters the DSC Task mode.

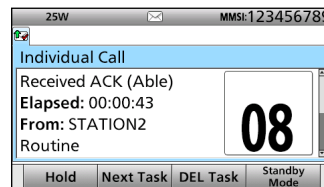

DSC Task mode

- Automatically selects the channel that you specified when you sent the call for voice communication.
- Rotate [CH/ENT] to view the call contents.
- See page 28 for details of the Task mode's software key functions.

- Hold down [PTT] to communicate.
- Push [Standby Mode]  to return to the Main screen.

8 DSC OPERATION

■ Receiving DSC calls

◇ Receiving an Individual acknowledgement (Continued)

When receiving “ACK (Unable)”:

You cannot make the voice communication.

- ① When an Individual acknowledgement “ACK (Unable)” is received:

- Alarm sounds.
- “📞” is displayed.
- The following screen is displayed and the backlight blinks.

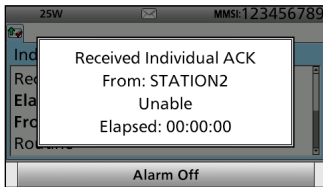

- ② Push any [Alarm Off] .

- ③ Push any [Close Call RCVD Window] .

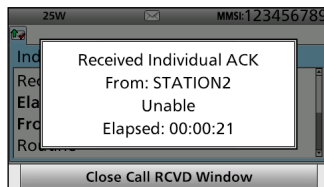

- Enters the DSC Task mode.

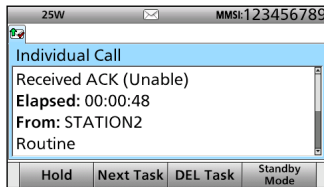

DSC Task mode

- Rotate [CH/ENT] to view the call contents.
- See page 28 for details of the Task mode's software key functions.

- ④ Push [Standby Mode]  to return to the Main screen.

When receiving “ACK (New CH)”:

You can make voice communication on the channel that is proposed by the called station.

- ① When an Individual acknowledgement “ACK (New CH)” is received:

- Alarm sounds.
- The following screen is displayed and the backlight blinks.
- “📞” is displayed.

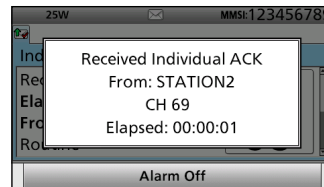

- ② Push any [Alarm Off] .

- ③ Push any [Close Call RCVD Window]

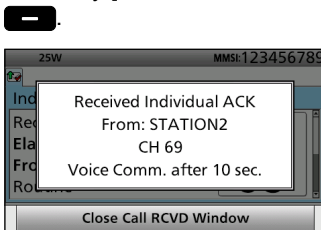

- Enter the DSC Task mode

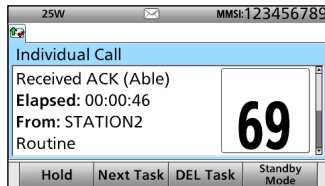

DSC Task mode

- Automatically selects the channel that is proposed by the called station for voice communication.
 - Rotate [CH/ENT] to view the call contents.
 - See page 28 for details of the Task mode's software key functions.
- ④ Hold down [PTT] to communicate.
- ⑤ Push [Standby Mode] to return to the Main screen.

◇ Receiving an All Ships call

- ① When an All Ships call is received:
- Alarm sounds.
 - The following screen is displayed and the backlight blinks.
 - “” is displayed and “” blinks.

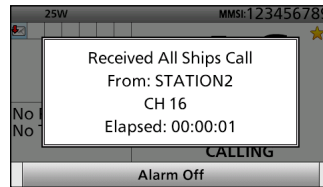

- ② Push any [Alarm Off] to stop the alarm.
- ③ Select your desired action.

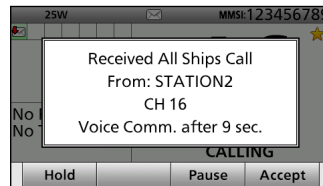

- [Hold]: Push [Hold] to return to the Main screen.
- [Pause]: Push [Pause] to pause the countdown.
- To restart the countdown, push [Resume].

- [Accept]: Push [Accept] to enter the DSC Task mode.

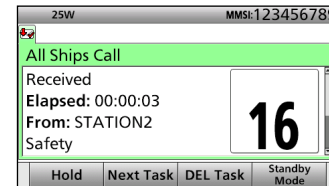

DSC Task mode

- Monitor the channel specified by the calling station for an announcement from the calling station. (Example: Channel 16)
 - Rotate [CH/ENT] to view the call contents.
 - See page 28 for details of the Task mode's software key functions.
- ④ Push [Standby Mode] to return to the Main screen.

8 DSC OPERATION

■ Receiving DSC calls (Continued)

◇ Receiving a Group call

- ① When a Group call is received:
 - Alarm sounds.
 - The following screen is displayed and the backlight blinks.
 - “” is displayed.

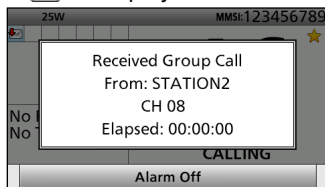

- ② Push any [Alarm Off] .
- ③ Select your desired action.

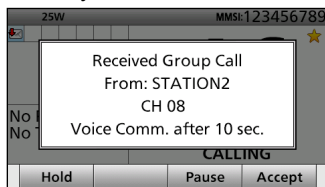

[Hold]: Holds the RX call task, and return to the previous screen.

[Pause]: Pauses the countdown.

- To restart the countdown, push [Resume] .

[Accept]: Enters the DSC Task mode.

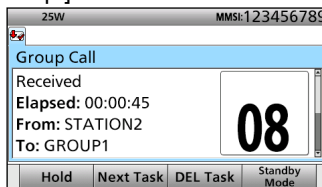



DSC Task mode

- Monitor the channel specified by the calling station for an announcement from the calling station. (Example: Channel 08)
 - Rotate [CH/ENT] to view the call contents.
 - See page 28 for details of the Task mode's software key functions.
- ④ Push [Standby Mode]  to return to the Main screen.

◇ Receiving a Geographical Area call

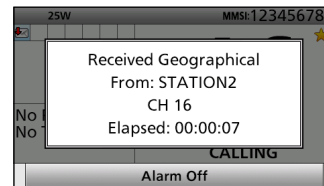
- ① When a Geographical Area call (for the area you are in) is received:
 - Alarm sounds.
 - The following screen is displayed and the backlight blinks.
 - “” is displayed.



- ② Push any [Alarm Off] .
- ③ Select your desired action.

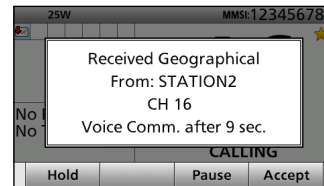

[Hold]: Holds the RX call task, and return to the previous screen.

- [Pause]: Pauses the countdown.
 - To restart the countdown, push [Resume] .
- [Accept]: Enters the DSC Task mode.

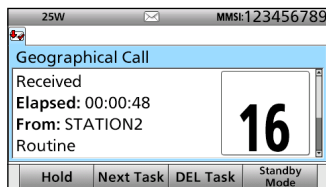



DSC Task mode

- Monitor the channel specified by the calling station for an announcement from the calling station. (Example: Channel 16)
 - Rotate [CH/ENT] to view the call contents.
 - See page 28 for details of the Task mode's software key functions.
- ④ Push [Standby Mode]  to return to the Main screen.

◇ Receiving a Position Request Call

NOTE: When "Position ACK" is set to "Auto," the transceiver automatically replies to the call. Both the TX and RX calls are stored in the Transmitted and Received Call Logs. (Default: Manual)

- ① When a Position Request call is received:
- Alarm sounds.
 - The following screen is displayed and the backlight blinks.
 -  is displayed and  blinks.



- ② Push any [Alarm Off] .
- ③ Select your desired action.

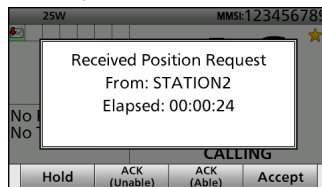

- [Hold]: Holds the RX call task, and return to the previous screen.
- [ACK (Unable)]: Sends an acknowledgment with no position and time data.
- [ACK (Able)]: Sends an acknowledgment with position and time data.
- [Accept]: Enters the DSC Task mode.

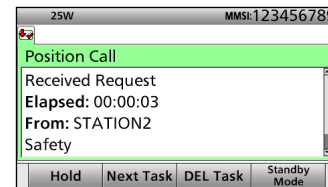

DSC Task mode

- Rotate [CH/ENT] to view the call contents.
 - See page 28 for details of the Task mode's software key functions.
- ④ Push [Standby Mode]  to return to the Main screen.

TIP: See page 48 for details of sending an acknowledgement.

8 DSC OPERATION

■ Receiving DSC calls (Continued)

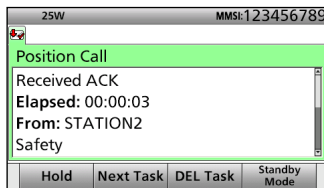
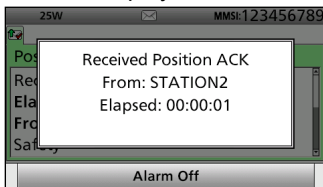

◇ Receiving a Position Request acknowledgement

- When a Position Request acknowledgement is received:
 - Alarm sounds.
 - The following screen is displayed and the backlight blinks.
 - "" is displayed.



DSC Task mode

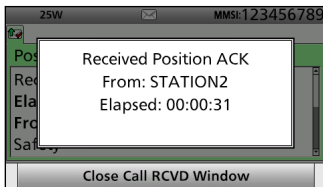

- Rotate [CH/ENT] to view the call contents.
 - See page 28 for details of the Task mode's software key functions.
- Push [Standby Mode]  to return to the Main screen.

- Push any [Alarm Off] .
- Push any [Close Call RCVD Window] .



- Enters the DSC Task mode.

◇ Receiving a Position Report call

- When a Position Report call is received:
 - Alarm sounds.
 - The following screen is displayed and the backlight blinks.
 - "" is displayed and "" blinks.

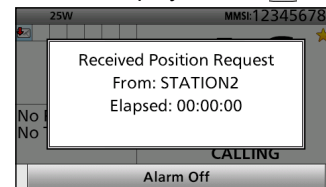

- Push any [Alarm Off] .
- Select your desired action.

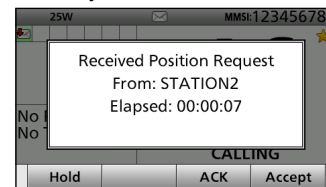

[Hold]: Holds the RX call task, and return to the previous screen.

[ACK]: Sends an acknowledgment.

[Accept]: Enters the DSC Task mode.

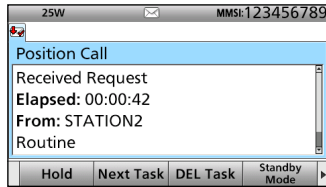



DSC Task mode

- Rotate [CH/ENT] to view the call contents, including the position data.
- See page 28 for details of the Task mode's software key functions.
- ④ Push [Standby Mode]  to return to the Main screen.

◇ Receiving a Polling Request call

NOTE: When “Polling ACK” is set to “Auto,” the transceiver automatically replies to the call. Both the TX and RX calls are stored in the Transmitted and Received Call Logs. (Default: Auto)

- ① When a Polling Request call is received:
 - Alarm sounds.
 - The following screen is displayed and the backlight blinks.
 - “” is displayed and “” blinks.

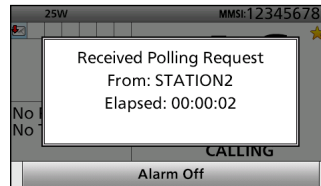

- ② Push any [Alarm Off] .
- ③ Select your desired action.

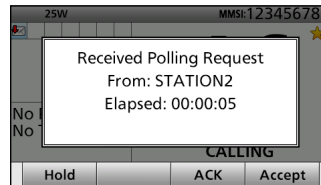

[Hold]: Holds the RX call task, and return to the previous screen.

[ACK]: Sends an acknowledgment.

[Accept]: Enters the DSC Task mode.

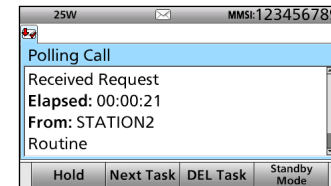

DSC Task mode

- Rotate [CH/ENT] to view the call contents.
- See page 28 for details of the Task mode's software key functions.
- ④ Push [Standby Mode]  to return to the Main screen.



TIP: See page 49 for details of sending an acknowledgement.

8 DSC OPERATION

■ Receiving DSC calls (Continued)

◇ Receiving a Test call

NOTE: When “Test ACK” is set to “Auto,” the transceiver automatically replies to the call. Both the TX and RX calls are stored in the Transmitted and Received Call Logs. (Default: Auto)

- When a Test call is received:
 - Alarm sounds.
 - The following screen is displayed and the backlight blinks.
 - “” is displayed and “” blinks.

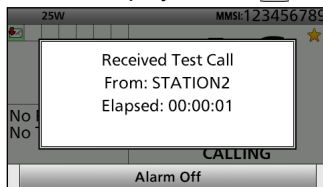

- Push any [Alarm Off] .
- Select your desired action.

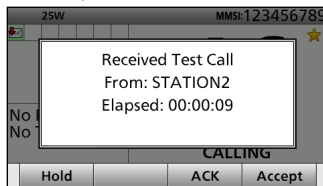

[Hold]: Holds the RX call task, and return to the previous screen.

[ACK]: Sends an acknowledgement.

[Accept]: Enters the DSC Task mode.

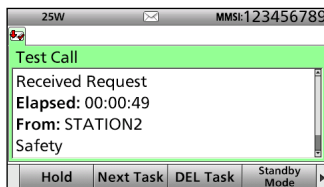

DSC Task mode



- Rotate [CH/ENT] to view the call contents.
 - See page 28 for details of the Task mode's software key functions.
- Push [Standby Mode]  to return to the Main screen.

TIP: See page 51 for details of sending an acknowledgement.

◇ Receiving a Test acknowledgement

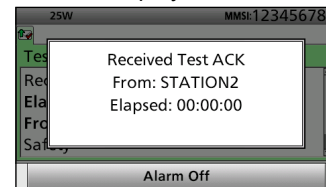
- When a Test acknowledgement is received:
 - Alarm sounds.
 - The following screen is displayed and the backlight blinks.
 - “” is displayed.



- Push any [Alarm Off] .
- Push any [Close Call RCVD Window] .

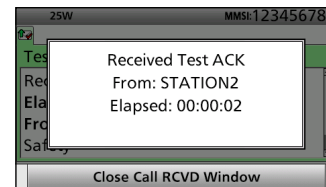

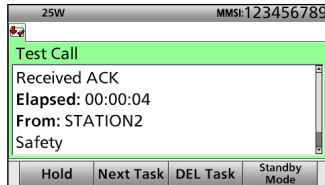

- Enters the DSC Task mode.





DSC Task mode

- Rotate [CH/ENT] to view the call contents.
 - See page 28 for details of the Task mode's software key functions.
- ④ Push [Standby Mode]  to return to the Main screen.

◇ Receiving a Medical Transports call

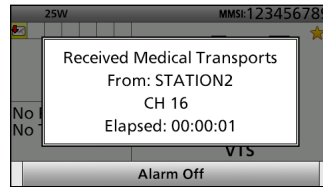
- ① When a Medical Transports call is received:
- Alarm sounds.
 - The following screen is displayed and the backlight blinks.
 -  is displayed and  blinks.



- ② Push any [Alarm Off] .
- ③ Select your desired action.

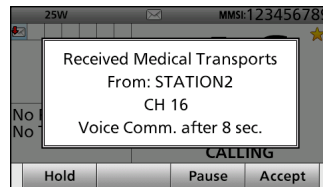

[Hold]: Holds the RX call task, and return to the previous screen.

- [Pause]: Pauses the countdown.
- To restart the countdown, push [Resume] .
- [Accept]: Enters the DSC Task mode.

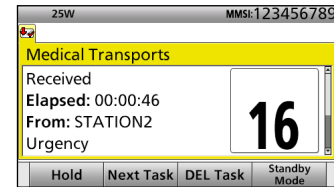



DSC Task mode

- Monitor the channel specified by the calling station for an announcement from the calling station. (Example: Channel 16)
 - Rotate [CH/ENT] to view the call contents.
 - See page 28 for details of the Task mode's software key functions.
- ④ Push [Standby Mode]  to return to the Main screen.

8 DSC OPERATION

■ Receiving DSC calls (Continued)

◇ Receiving a Ships and Aircraft call

- ① When a Ships and Aircraft call is received:
 - Alarm sounds.
 - The following screen is displayed and the backlight blinks.
 - “” is displayed and “” blinks.

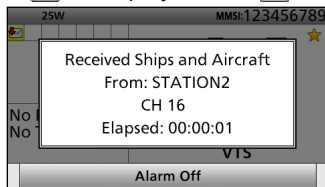

- ② Push any [Alarm Off] .
- ③ Select your desired action.

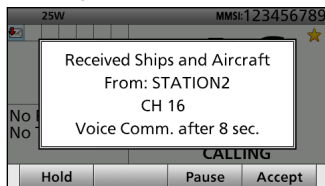

[Hold]: Holds the RX call task, and return to the previous screen.

[Pause]: Pauses the countdown.

- To restart the countdown, push [Resume] .

[Accept]: Enters the DSC Task mode.

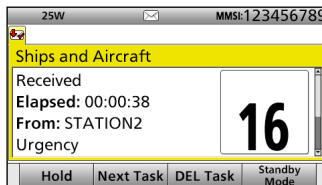



DSC Task mode

- Monitor the channel specified by the calling station for an announcement from the calling station. (Example: Channel 16)
 - Rotate [CH/ENT] to view the call contents.
 - See page 28 for details of the Task mode's software key functions.
- ④ Push [Standby Mode]  to return to the Main screen.

■ Received Call log

The transceiver automatically stores up to 50 distress messages and 50 other messages, and they can be used as a supplement to your logbook.

- When there is an unread DSC message,  blinks on the information area of the LCD.
-  is displayed when there are unread DSC messages.
-  is displayed when there are no unread DSC messages.
- No icon is displayed when there are no DSC messages.
- Distress messages are stored in "Distress."

Software key functions in the RCVD CALL LOG screen:

- [Exit]: Push to return to the Main screen.
 [Back]: Push to return to the previous screen.
 [Print]: Push to print out the selected message when a printer is connected to the transceiver.
 [Enter]: Push to go to the next screen.
 [Delete]: Push to delete the selected message.

◇ Distress message

- ① Push [DSC Log]  to display the RCVD CALL LOG screen.
 - To display the screen from the Menu screen:
 ([MENU] > DSC Log > **Received Call Log**)
- ② Select "Distress," then push [ENT].
- ③ Select the desired message, then push [ENT].

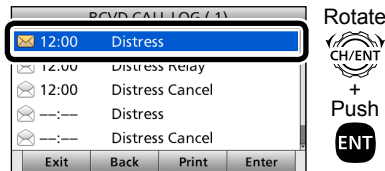

- ④ Rotate [CH/ENT] to view the contents.
 - To view another message, push [CLR] to return to the previous screen. And then, select the desired message.
- ⑤ Push [Exit]  to return to the Main screen.

◇ Other messages

- ① Push [DSC Log]  to display the RCVD CALL LOG screen.
 - To display the screen from the Menu screen:
 ([MENU] > DSC Log > **Received Call Log**)
- ② Select "Others," then push [ENT].
- ③ Select the desired message, then push [ENT].

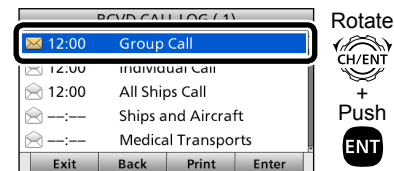

- ④ Rotate [CH/ENT] to view the contents.
 - To view another message, push [CLR] to return to the previous screen. And then, select the desired message.
- ⑤ Push [Exit]  to return to the Main screen.

■ Transmitted Call log

The transceiver automatically stores up to 50 transmitted calls, and the logs can be used as a supplement to your logbook.

Software key functions in the TX CALL LOG screen:

[Exit]: Push to return to the Main screen.

[Back]: Push to return to the previous screen.

[Print]: Push to print out the selected message when a printer is connected to the transceiver.

[Enter]: Push to go to the next screen.

[Delete]: Push to delete the selected message.

- ① Push [MENU].
- ② Select "Transmitted Call Log."
(DSC Log > **Transmitted Call Log**)

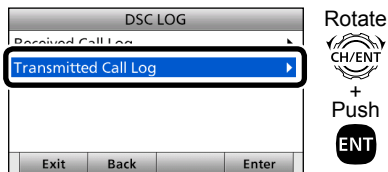

- ③ Select the desired message, then push [ENT].

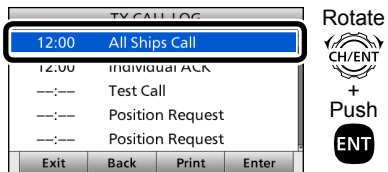

- ④ Rotate [CH/ENT] to view the contents.
 - To view another message, push [CLR] to return to the previous screen. And then, select the desired message.
- ⑤ Push [Exit]  to return to the Main screen.

■ DSC Settings

- ◇ Position Input (See page 25)
- ◇ Individual ID (See page 23)
- ◇ Group ID (See page 24)

◇ Automatic Acknowledgement

You can set the Automatic Acknowledgment function to acknowledge DSC calls.

When you receive an Individual call, Position Request call, Polling Request call or Test call, the transceiver automatically sends each acknowledgement, if “Auto” is set.

When you set the “Individual ACK” item to “Auto (Unable),” and receive the Individual call, the transceiver automatically sends the acknowledgment, including “ACK (Unable)” (No Reason Given).

- ① Push [MENU].
- ② Select the desired item.
(DSC Settings > **Individual ACK**)
(DSC Settings > **Position ACK**)
(DSC Settings > **Polling ACK**)
(DSC Settings > **Test ACK**)
- ③ Select the desired option, then push [ENT].

Individual ACK

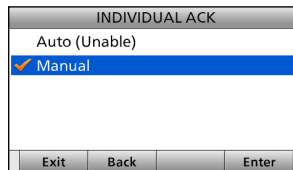

(Default: Manual)

Position ACK

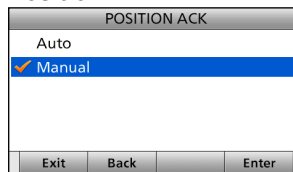

(Default: Manual)

Polling ACK

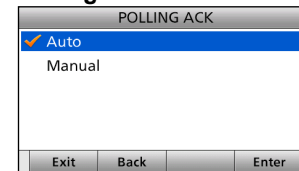

(Default: Auto)

Test ACK

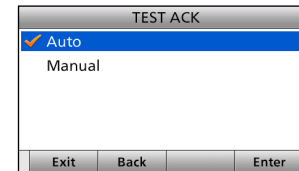

(Default: Auto)

- ④ Push [MENU] to return to the Main screen.

8 DSC OPERATION

■ DSC Settings (Continued)

◇ Setting the “Medical Transports” item display option

You can select whether the “Medical Transports” item is displayed in the COMPOSE NON-DISTRESS screen or not.

- ① Push [MENU].
- ② Select “Medical Transports,” then push [ENT].
(DSC Settings > **Medical Transports**)

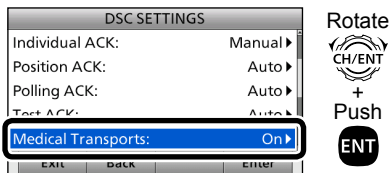

- ③ Select the desired option, then push [ENT].
 - On: Displayed in the COMPOSE NON-DISTRESS screen.
 - Off: Not displayed in the COMPOSE NON-DISTRESS screen. (Default)
- ④ Push [MENU] to return to the Main screen.

◇ Setting the “Ships and Aircraft” item display option

You can select whether the “Ships and Aircraft” item is displayed in the COMPOSE NON-DISTRESS screen or not.

- ① Push [MENU].
- ② Select “Ships and Aircraft,” then push [ENT].
(DSC Settings > **Ships and Aircraft**)

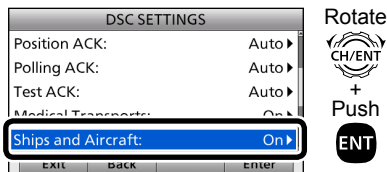

- ③ Select the desired option, then push [ENT].
 - On: Displayed in the COMPOSE NON-DISTRESS screen.
 - Off: Not displayed in the COMPOSE NON-DISTRESS screen. (Default)
- ④ Push [MENU] to return to the Main screen.

◇ Setting the 10 Second Delay

Select whether or not the transceiver automatically switches to Channel 16, 10 seconds after receiving a Distress call.

By regulation, after receiving a Distress call, the transceiver normally switches the operating channel to Channel 16. However, when this setting is OFF, the transceiver remains on the operating channel to continue the current communication, even after receiving a Distress call.

- ① Push [MENU].
- ② Select “10 Second Delay,” then push [ENT].
(DSC Settings > 10 Second Delay)

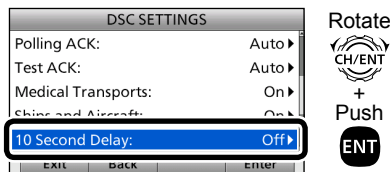

- ③ Select the desired option, then push [ENT].
 - On: After receiving a DSC call, the transceiver remains on the current operating channel for 10 seconds. After that, the transceiver automatically switches to the specified channel. (Default)
 - Off: The transceiver remains on the operating channel even after receiving a DSC call.
- ④ Push [MENU] to return to the Main screen.

◆ Setting the Alarm Status

- **Safety**
 - **Routine**
- Select whether or not to sound an alarm when receiving the Safety or Routine DSC call.

- ① Push [MENU].
- ② Select the desired item, then push [ENT].
(DSC Settings > Alarm Status > **Safety**)
(DSC Settings > Alarm Status > **Routine**)

(Example: Safety)

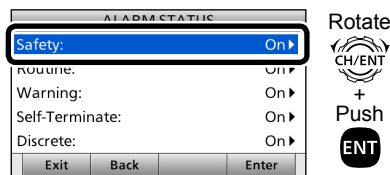

- ③ Select the desired option, then push [ENT].
 - On: Alarm sounds. (Default)
 - Off: Alarm does not sound.
- ④ Push [MENU] to return to the Main screen.

- **Warning**
- Select whether or not to sound an alarm:
- When no MMSI code is entered.
 - When the position data has not been updated for 10 minutes.
 - When the position data has not been manually updated for 4 hours.
 - After the invalid GPS position data or manually entered position data has not been updated for 23.5 hours.

- ① Push [MENU].
- ② Select “Warning,” then push [ENT].
(DSC Settings > Alarm Status > **Warning**)

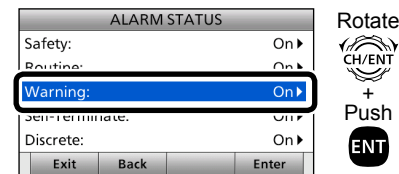

- ③ Select the desired option, then push [ENT].
 - On: Alarm sounds. (Default)
 - Off: Alarm does not sound.
- ④ Push [MENU] to return to the Main screen.

8 DSC OPERATION

■ DSC Settings

◇ Setting the Alarm Status (Continued)

• Self-Terminate

Select whether or not to sound an alarm when receiving the same Distress call.

- ① Push [MENU].
- ② Select “Self-Terminate,” then push [ENT].
(DSC Settings > Alarm Status > **Self-Terminate**)

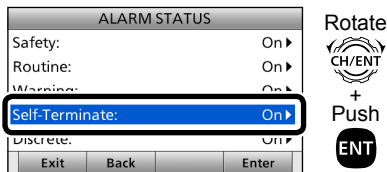

- ③ Select the desired option, then push [ENT].
 - On: Alarm sounds. (Default)
 - Off: Alarm does not sound.
- ④ Push [MENU] to return to the Main screen.

• Discrete

Select whether or not to sound an alarm when receiving a lower priority DSC call while receiving a higher priority call.

- ① Push [MENU].
- ② Select “Discrete,” then push [ENT].
(DSC Settings > Alarm Status > **Discrete**)

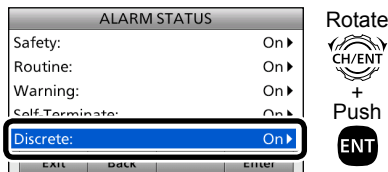

- ③ Select the desired option, then push [ENT].
 - On: Alarm sounds. (Default)
 - Off: Alarm does not sound.
- ④ Push [MENU] to return to the Main screen.

◇ Setting the Channel 70 Squelch level

Set the squelch level on Channel 70. The transceiver has 11 squelch levels between 1 (loose squelch), 10 (tight squelch) and ‘Open’ (squelch is completely open).

- ① Push [MENU].
- ② Select “CH 70 SQL Level,” then push [ENT].
(DSC Settings > **CH 70 SQL Level**)

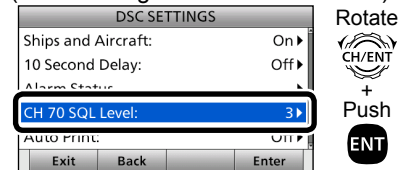

- ③ Adjust the squelch level until the noise just disappears.

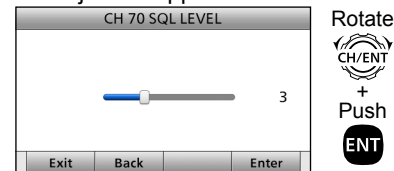

- ④ Push [MENU] to return to the Main screen.

◇ Auto Print

Select whether or not to enable the Automatic Print Out function when a DSC call is received.

The received DSC call content is printed out if a printer is connected to the transceiver.

- ① Push [MENU].
- ② Select “Auto Print,” then push [ENT].
(DSC Settings > **Auto Print**)

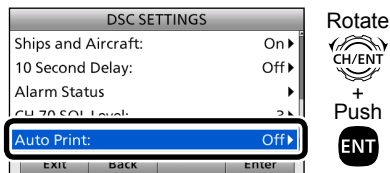

- ③ Select the desired option, then push [ENT].
 - On: The received DSC call content is printed out.
 - Off: The received DSC call content is not printed out. (Default)
- ④ Push [MENU] to return to the Main screen.

◇ DSC Loop Test

The DSC loop test function sends transmit DSC signals to the receive AF circuit to compare and check the TX and RX signals at the AF level.

- ① Push [MENU].
- ② Select “DSC Loop Test,” then push [ENT].
(DSC Settings > **DSC Loop Test**)

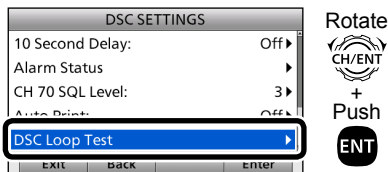

- ③ Push [ENT] to start the DSC loop test.

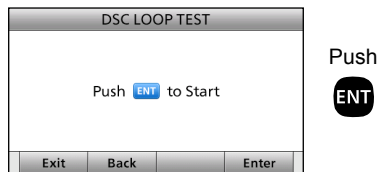

- When the transmit DSC and receive DSC signals are matched, “OK” is displayed.

■ Menu items

The Menu screen is constructed in a tree structure. (p. 10)

See page 12 to enter the Menu screen.

The following items are described in each section.
Refer to the specified pages for details.

◇ Compose Distress (p. 30)

◇ Compose Non-Distress

- Individual call (p. 42)
- All Ships (p. 45)
- Group (p. 46)
- Position (p. 47)
- Test (p. 50)
- Medical Transports (p. 52)
- Ships and Aircraft (p. 53)

◇ Compose DROBOSE (p. 36)

◇ DSC Log (pp. 69, 70)

◇ DSC Settings (p. 71)

◇ Radio Settings

item	Ref.	item	Ref.
Scan Type	p. 77	Call Channel	p. 77
Scan Timer	p. 77	FAV on MIC	p. 78
Dual/Tri-Watch	p. 77	FAV Settings	p. 76

◇ Configuration

item	Ref.	item	Ref.
Key Beep	p. 78	NMEA Data Output	p. 80
UTC Offset	p. 78	DSC Data Output	p. 80
Inactivity Timer	p. 79	POS Data Output	p. 81
Not DSC Related	p. 79	Internal Speaker	p. 81
DSC Related	p. 79	MIC Type	p. 81
Distress Related	p. 79	Software Version	p. 81
RT Related	p. 80		

■ Radio Settings

◇ Scan Type

(Radio Settings > **Scan Type**)

Select the desired Scan type to locate signals. (p. 21)

- Normal Scan: Sequentially searches all Favorite channels.
- Priority Scan: Sequentially searches all Favorite channels, while also monitoring Channel 16. (Default)

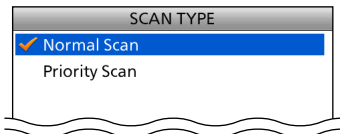

◇ Scan Timer

(Radio Settings > **Scan Timer**)

Turn the Scan Resume timer ON or OFF.

- On: When a signal is detected on a channel, the scan pauses for 5 seconds, and then resumes. If the signal disappears in less than 5 seconds, the scan immediately resumes.
- Off: When a signal is detected on a channel, the scan pauses until the signal disappears, and then resumes. (Default)

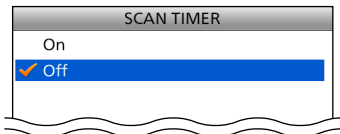

◇ Dual/Tri-Watch

(Radio Settings > **Dual/Tri-Watch**)

Select the desired watch type. (p. 22)

- Dualwatch: The transceiver monitors Channel 16, while listening or talking on another channel. (Default)
- Tri-watch: The transceiver monitors Channel 16 and the Call channel, while listening or talking on another channel.



◇ Call Channel

(Radio Settings > **Call Channel**)

You can set the Call channel with your most often-used channel for quick recall. (p. 14) (Default: Channel 16)

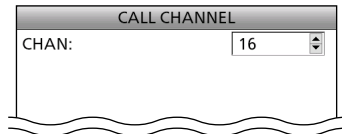

9 MENU ITEMS

■ Radio Settings (Continued)

◇ FAV on MIC

(Radio Settings > **FAV on MIC**)

Turn the FAV on MIC function ON or OFF.

- On: Pushing [▲] or [▼] on the supplied microphone scrolls up and down through only the Favorite channels. (Default)
- Off: Pushing [▲] or [▼] on the supplied microphone scrolls up and down through all channels.



◇ FAV Settings

(Radio Settings > **FAV Settings**)

Set the Favorite channel settings.

- Set All Channels: Sets all channels as Favorite channels.
- Clear All Channels: Clears all Favorite channels.
- Set Default: Returns to the default setting.

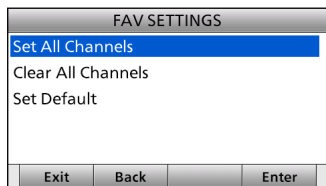

■ Configuration

◇ Key Beep

(Configuration > **Key Beep**)

Turn the Key Beep function ON or OFF.

- On: Sounds a beep when pushing a key. (Default)
- Off: Does not sound a beep when pushing a key for silent operation.

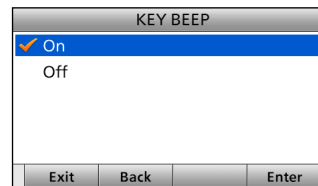

◇ UTC Offset

(Configuration > **UTC Offset**)

Set the offset time between UTC (Universal Time Coordinated) and your local time to between -14:00 and +14:00 (in 1 minute steps). (Default: 00:00)

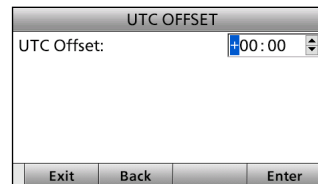

◇ Inactivity Timer

(Configuration > **Inactivity Timer**)

Set the inactivity timer to between 1 and 15 minutes (in 1 minute steps) or OFF.

The count down alarm sounds 10 seconds before the Inactive timer activates.

INACTIVITY TIMER		
Not DSC Related:	10 min ▶	
DSC Related:	15 min ▶	
Distress Related:	Off ▶	
RT Related:	30 sec ▶	
Exit	Back	Enter

• Not DSC Related

(Configuration > Inactivity Timer > **Not DSC Related**)

The transceiver automatically returns to the Main screen if no key is pushed for this set time period. (Default: 10 min)

This setting is for when the LCD displays a screen that is not related to DSC screen other than the Main screen.

INACTIVITY TIMER		
6 min		
7 min		
8 min		
9 min		
✓ 10 min		
Exit	Back	Enter

• DSC Related

(Configuration > Inactivity Timer > **DSC Related**)

The transceiver automatically returns to the Main screen if no key is pushed for this set time period. (Default: 15 min)

This setting is for when the LCD displays a screen that is related to DSC.

INACTIVITY TIMER		
11 min		
12 min		
13 min		
14 min		
✓ 15 min		
Exit	Back	Enter

• Distress Related

(Configuration > Inactivity Timer > **Distress Related**)

The transceiver automatically returns to the Main screen if no key is pushed for this set time period. (Default: Off)

This setting is for when the LCD displays a screen that is related to a Distress call.

INACTIVITY TIMER		
✓ Off		
1 min		
2 min		
3 min		
4 min		
Exit	Back	Enter

9 MENU ITEMS

■ Configuration

◇ Inactivity Timer (Continued)

• RT Related

(Configuration > Inactivity Timer > **RT Related**)

The transceiver automatically returns to the standby mode if you push no key for this set time period. (Default: 30 sec)

This setting is for when the transceiver is in the Radio

Telephone mode.

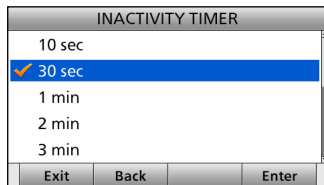

◇ NMEA Data Output

(Configuration > **NMEA Data Output**)

Set the NMEA 0183 Output functions.

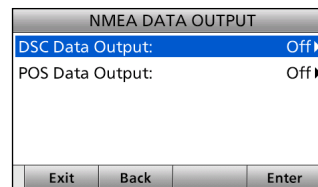

• DSC Data Output

(Configuration > NMEA Data Output > **DSC Data Output**)

Select an option for the DSC Data Output function.

When receiving a DSC call, the transceiver outputs the NMEA sentences (DSC and DSE) from the NMEA 0183 output port to an external device.

- All Stations: Outputs the NMEA sentences.
- Station List: Outputs the NMEA sentences when you receive a call from the station whose address is entered in your Individual ID list.
- Off: Does not output the NMEA sentences. (Default)

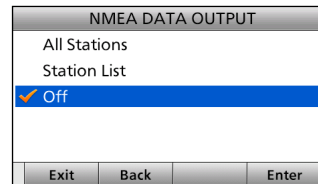

• **POS Data Output**

(Configuration > NMEA Data Output > **POS Data Output**)

Select whether or not to output your position data from the NMEA 0183 output port.

- On: Outputs the position data.
- Off: Does not output the position data. (Default)

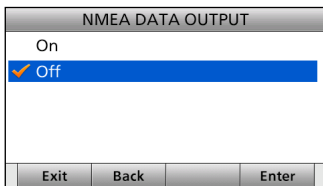

◇ **Internal Speaker**

(Configuration > **Internal Speaker**)

Turn the internal speaker ON or OFF. (Default: On)

When you connect an external speaker, and the transceiver's internal speaker is not used, the internal speaker is deactivated.

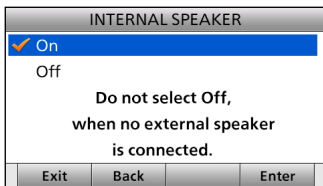

◇ **MIC Type**

(Configuration > **MIC Type**)

Select the desired microphone type.

- HM-214V: To use the supplied microphone. (Default)
- HS-98: To use the optional handset.

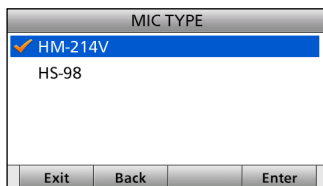

IMPORTANT: When using the optional HS-98.

First set this item to "HS-98." Then, turn OFF the transceiver, and connect the HS-98. (p. 88) After turning ON the transceiver again, you can use the HS-98.

- If this item is set to "HM-214V," and when the HS-98 is connected, the transceiver's keys are disabled.

◇ **Software Version**

This item displays the transceiver's software version number.

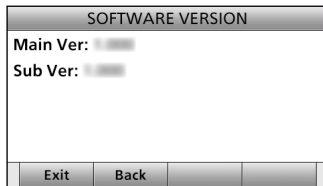

10 CONNECTIONS AND MAINTENANCE

■ Connections

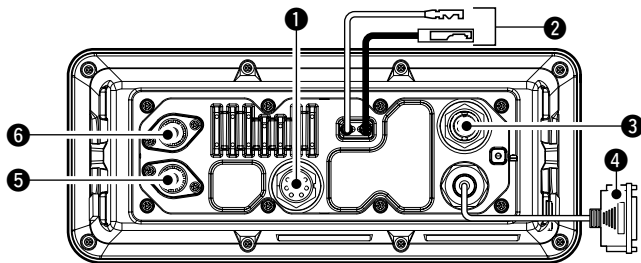

1 NMEA 0183 CONNECTORS

- Connects to IEC61162-1 Out lines of a PC or IEC61162-1 sentence format DSC or DSE compatible navigation equipment, to receive position data from other ships.
- Connects to IEC61162-1 In lines of a GPS receiver for position data.
 - A GPS receiver compatible with IEC61162-1 format RMC, GGA, GNS, or GLL and VTG sentences is required. Ask your dealer about suitable GPS receivers.

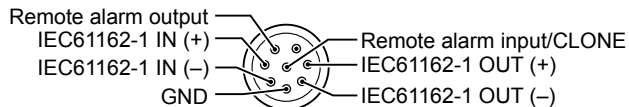

Transceiver's rear panel view

Remote alarm output terminal

- 4 V DC*
- Maximum 10 mA*

*When the external equipment is connected between this terminal and the GND terminal.

When DSC call that is related to "Distress" as described below is received, 4 V DC is output and the key backlight blinks.

- Distress call
- Distress acknowledgement
- Distress Relay call
- Distress Relay acknowledgement
- Distress Cancel call
- DSC call whose category is "Distress"

Remote alarm input terminal

When this terminal shorts to the GND terminal, the transceiver sends the Distress call.

This terminal can be used as an external distress switch.

2 DC POWER CONNECTOR

Connects the PS-310 with the DC power cable of the PS-310. (p. 86)

CAUTION: After connecting the DC power cable, cover the connector with a tape, as shown below, to prevent water seeping into the connection.

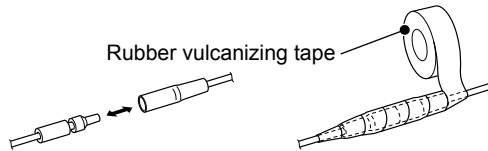

3 EXTERNAL SPEAKER/VDR CONNECTOR

Connects to a voice recorder or an external speaker.

- Lead: Thicker than 0.75 sq mm,
- Length: Shorter than 1.5 m is recommended.

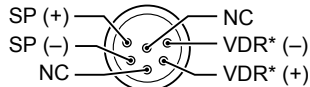

*VDR: Voyage Data Recorder

Transceiver's rear panel view

4 D-SUB 25-PIN

Connects to a printer (IBM® centronics or compatible) to print out the received DSC call contents.

5 ANTENNA CONNECTOR (to receive on Channel 70)

6 ANTENNA CONNECTOR

Connects to a marine VHF antenna with a PL-259 connector.

CAUTION: Transmitting without an antenna (6) above may damage the transceiver.

◇ IEC61162-1 In/Out lines' specifications

PIN	SPECIFICATIONS
IEC61162-1 OUT (+)	Output level: 5 V/40 mA maximum (RS-422 balanced type)
IEC61162-1 OUT (-)	
IEC61162-1 IN (+)	Input level: Less than 2 mA (at 2 V applied)
IEC61162-1 IN (-)	

10 CONNECTIONS AND MAINTENANCE

■ Connections (Continued)

◇ Software maintenance

The Icom customer support center provides the firmware file for the transceiver's maintenance. You can update the transceiver's firmware through a PC.

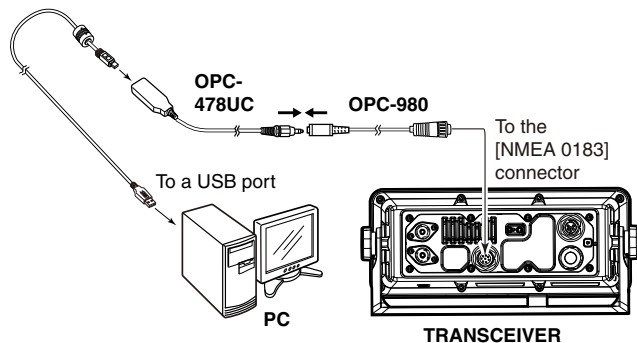

■ Antenna

A key element in the performance of any communication system is the antenna. Ask your dealer about antennas and the best place to mount them.

■ Fuse replacement

One fuse is installed in the supplied DC power cable. If the fuse blows, track down the source of the problem, repair it, and replace the damaged fuse with a new one of the proper rating.

Fuse rating: 10 A

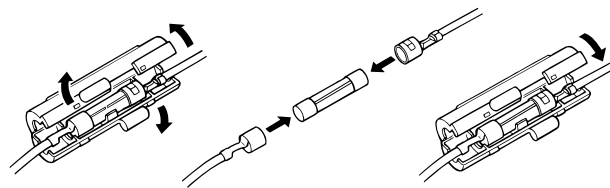







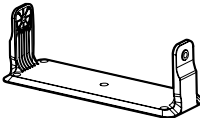

■ Cleaning

If the transceiver becomes dusty or dirty, wipe it clean with a soft, dry cloth.



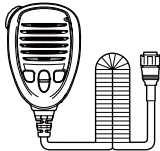



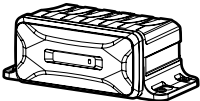

DO NOT use harsh solvents such as Benzine or alcohol, as they will damage transceiver surfaces.

■ Supplied accessories

 <p>Mounting bracket</p>	<p>For the mounting bracket</p>	
	<p>Knob bolts</p> 	<p>Flat washers (M5)</p> 
	<p>Screws (5×20 mm)</p> 	<p>Spring washers (M5)</p> 
 <p>Microphone</p>	<p>Sponges</p> 	<p>Accessory connectors</p>  <p>6 pin 8 pin</p>
 <p>Microphone hanger and screws (3×16 mm)</p>	 <p>DC power cable (OPC-891A)*1</p>	<p>*1 Used for the transceiver's operation check. (12 V DC only)</p>

The following items are sold as a set with the GM600.

 <p>PS-310</p>	<p>Screws (5×20 mm)</p> 	<p>Spring washers (M5)</p> 
	<p>Spare fuse (FGB 15 A)</p> 	<p>Flat washers (M5)</p> 
 <p>DC power cable (OPC-2352)</p>	<p>Ferrite EMI filter + Tie wrap</p> 	

◇ Accessory connectors set up

The accessory connectors are used on the accessory cables.

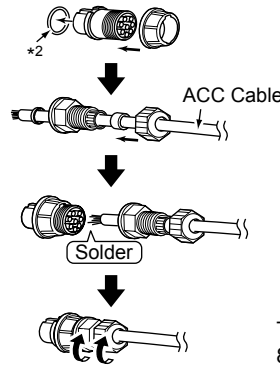

These illustrations are for the 8-pin connector.

*2 Be sure to set this ring to keep the waterproof capability.

10 CONNECTIONS AND MAINTENANCE

■ Power source connections

◇ Connecting to the DC power source through the PS-310

To operate the GM600, you must connect it to a 12 or 24 volt DC power source through the PS-310 DC-DC POWER SUPPLY, sold as a set with the GM600.

The PS-310 converts the input voltage from the 12 or 24 volt DC power source, then provides stable 12.6 V DC, 5.5 A of continuous power to the transceiver.

Select the appropriate version for your vessel power system.

• PS-310

Version	Input voltage	Output voltage
#01	21.6 to 31.2 V DC	12.6 V DC
#02	10.8 to 15.6 V DC	12.6 V DC

CAUTION:

Before connecting the DC power cable, confirm the transceiver is OFF, and the DC power cable polarity is correct.

- Red: positive + terminal
- Black: negative - terminal

BE SURE to connect only the DC power cable from the PS-310, and **DO NOT** extend the cable length.

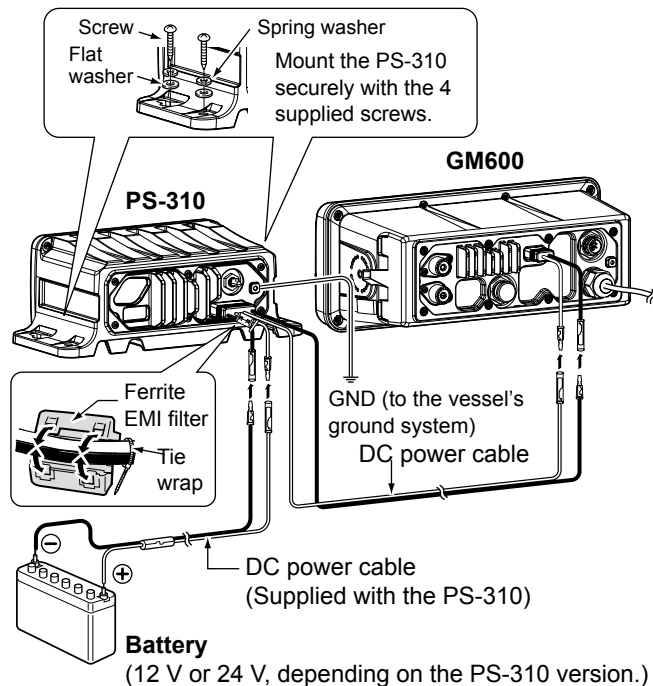

■ Mounting the transceiver

The supplied universal mounting bracket with your transceiver enables overhead or flat mounting.

- Mount the transceiver securely with the 4 supplied screws (M5 × 20) to a surface that is more than 10 mm thick and can support more than 5 kg.
- Mount the transceiver so its face is at 90° to your line of sight when operating.

CAUTION: Keep the transceiver and microphone at least 1 meter away from your vessel's magnetic navigation compass.

NOTE:

- Check the installation angle; the function display may not be easy to read at some angles.
- When mounting the transceiver on the place that is prone to strong vibration, use the supplied sponges between the transceiver and mounting bracket to reduce the effect of the vibration.

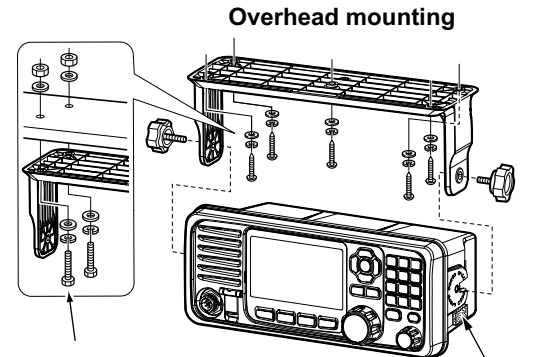

These screws are shown as only a mounting example. Not supplied accessories.

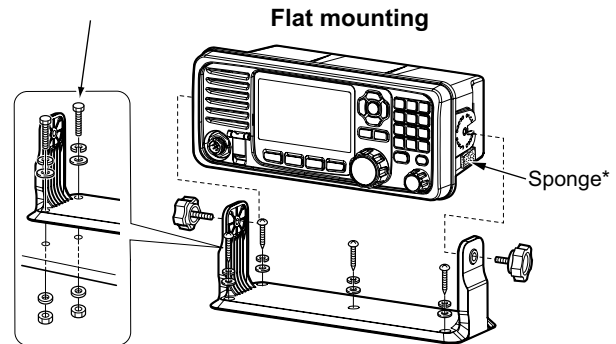

*Sponges reduce the vibration effects. See NOTE to the left.

■ Handset (HS-98)

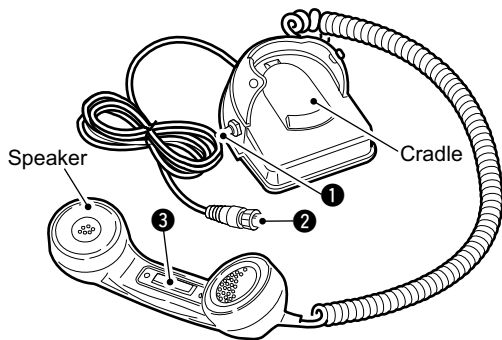

IMPORTANT: When using the optional HS-98

First set the "MIC Type" item to "HS-98" in the Menu screen. Then, turn OFF the transceiver, and connect the HS-98. After turning ON the transceiver again, you can use the HS-98. (p. 81)

◇ Connection

Insert the connector into the [MIC CONNECTOR] on the front panel, and tighten the cable nut, as shown below.

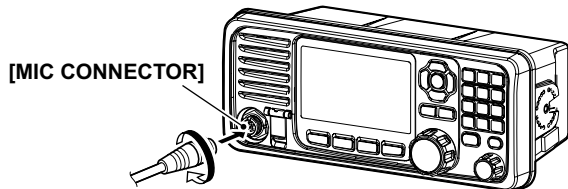

① SPEAKER SWITCH

When the switch is set to the "☐" position:

You can hear the receive audio from the remote controller speaker.

When the switch is set to the "☒" position:

Mutes the remote controller speaker output.

- You can hear the receive audio from the handset. Put the handset into the cradle to output the receive audio from the remote controller speaker.

② HANDSET CONNECTOR

Insert the connector into the [MIC CONNECTOR] on the front panel.

③ PTT SWITCH [PTT]

Hold down to transmit, release to receive.

■ Specifications

This specification is described when the GM600 is used with the PS-310 DC-DC POWER SUPPLY.

All stated specifications are subject to change without notice or obligation.

◇ General

- Frequency coverage: TX 156.025 ~ 161.600 MHz
RX 156.300 ~ 162.000 MHz
156.525 MHz (CH70/DSC)
- Mode: FM (16K0G3E), DSC (16K0G2B)
- Operating temp. range: -15°C to +55°C
- Current drain (at 24 V): TX high (25 W) 3.3 A
Maximum audio 2.0 A
- Power supply requirement: 12/24 V DC (negative ground)
PS-310 Input voltage: 21.6 to 31.2 V (#01)
10.8 to 15.6 V (#02)
- Frequency error: ±0.5 kHz (-15°C to +55°C)
- Antenna impedance: 50 Ω nominal (Unbalanced)
- Dimensions (Projections not included):
GM600: 263 (W) × 110 (H) × 109.4 (D) mm
PS-310: 216 (W) × 79 (H) × 125 (D) mm
- Weight (approximately):
GM600: 1.6 kg
PS-310: 930 g

◇ Transmitter

- Output power: 25 W or 1 W
- Modulation system: Variable reactance frequency modulation

- Max. frequency deviation: ±5.0 kHz
- Spurious emissions: Less than 0.25 μW
- Adjacent channel power: More than 70 dB
- Audio harmonic distortion: Less than 10%
(at 1 kHz, 60% deviation)
- Residual modulation: More than 40 dB
- Audio frequency response: +1 to -3 dB of 6 dB/octave range from 300 Hz to 3000 Hz

◇ Receiver

- Receive system: Double conversion superheterodyne
- Sensitivity:
FM: -7 dBμ emf (typical) (20 dB SINAD)
DSC (CH70): -7 dBμ emf (typical) (1% BER)
- Squelch sensitivity: Less than -2 dBμ
- Intermodulation: More than 75 dB
More than 73 dBμ emf (CH70/DSC)
- Spurious response: More than 75 dB
More than 73 dBμ emf (CH70/DSC)
- Adjacent channel selectivity: More than 75 dB
More than 73 dBμ emf (CH70/DSC)
- Audio output power: More than 3.5 W* into the internal speaker
*More than 2 W if an external speaker (4 Ω) is connected.
More than 10 W at 10% distortion into a 4 Ω load (external speaker)
- Ham and noise: More than 40 dB
- Audio frequency response: +1 to -3 dB of -6 dB/octave range from 300 Hz to 3000 Hz

11 SPECIFICATIONS AND OPTIONS

◇ Dimensions

GM600

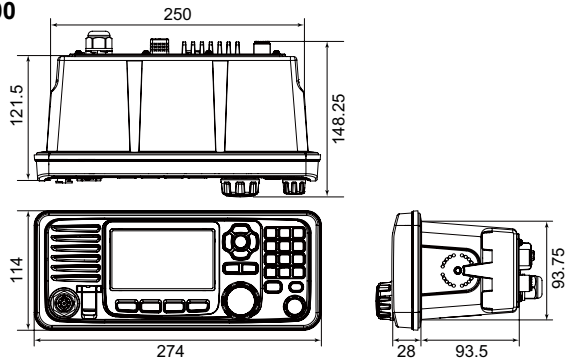

PS-310

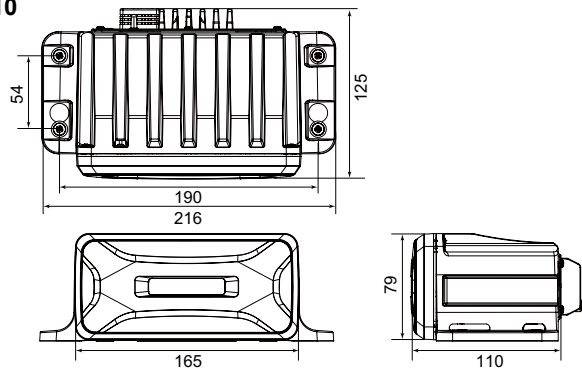

■ Options

• PS-310 DC-DC POWER SUPPLY

Provides stable 12.6 V DC output converted from a DC power source.

Version	Input voltage	Output voltage
#01	21.6 to 31.2 V DC	12.6 V DC
#02	10.8 to 15.6 V DC	12.6 V DC

• HS-98 HANDSET

Provides clear audio reception during offshore conditions and comes in handy for listening privacy on board.

Approved Icom optional equipment is designed for optimal performance when used with an Icom transceiver. Icom is not responsible for the destruction or damage to an Icom transceiver in the event the Icom transceiver is used with equipment that is not manufactured or approved by Icom.

PROBLEM	POSSIBLE CAUSE	SOLUTION	REF.
The transceiver does not turn ON.	<ul style="list-style-type: none"> • Bad connection to the power supply. • Fuse blows. 	<ul style="list-style-type: none"> • Check the connection to the transceiver and power supply. • Repair the problem, and then replace the fuse. 	<p>p. 86</p> <p>p. 84</p>
Little or no sound comes from the speaker.	<ul style="list-style-type: none"> • Squelch level is set too high. • Volume level is set too low. • The internal speaker is OFF. 	<ul style="list-style-type: none"> • Set the squelch to the threshold point. • Set the volume to a suitable level. • Turn ON the internal speaker. 	<p>p. 15</p> <p>p. 15</p> <p>p. 81</p>
You cannot transmit, or cannot select high power.	<ul style="list-style-type: none"> • Some channels are set for low power or receive only by regulations. • The output power is set to low. 	<ul style="list-style-type: none"> • Change channels. • Push [HI/LO] to select high power. 	<p>pp. 13</p> <p>93</p> <p>p. 15</p>
Scan does not start.	<ul style="list-style-type: none"> • More than 2 favorite channels are not set. 	<ul style="list-style-type: none"> • Set the desired channels as Favorite channels. 	<p>pp. 21,</p> <p>78</p>
No beep sounds.	<ul style="list-style-type: none"> • The Key Beep function is OFF. 	<ul style="list-style-type: none"> • Turn ON the Key Beep function. 	<p>p. 78</p>
The Main screen is not displayed at power ON.	<ul style="list-style-type: none"> • MMSI (DSC self ID) code is not set. 	<ul style="list-style-type: none"> • Set the MMSI (DSC self ID) code. 	<p>p. 9</p>
Individual or Group ID cannot be set.	<ul style="list-style-type: none"> • The entered ID code is incorrect. First digit must be set to between '1' and '9' for the Individual ID. First digit must be set to '0' for the Group ID. 	<ul style="list-style-type: none"> • Enter a correct ID code. 	<p>pp. 23,</p> <p>24</p>
"??" blinks instead of the position and time.	<ul style="list-style-type: none"> • 4 hours have passed after you manually entered the position. • The GPS position is invalid. 	<ul style="list-style-type: none"> • Enter the position. 	<p>p. 25</p>

12 TROUBLESHOOTING

PROBLEM	POSSIBLE CAUSE	SOLUTION	REF.
“NO POSITION” and “NO TIME” are displayed instead of the position and time.	<ul style="list-style-type: none">• A GPS receiver is not correctly connected.• The position and time have not been manually entered.	<ul style="list-style-type: none">• Check the GPS receiver connection.• Enter the position and time.	p. 82 p. 25
Sensitivity is too low, and only strong signals can be heard.	<ul style="list-style-type: none">• The antenna is defective or the coaxial cable connector is shorted or cut.	<ul style="list-style-type: none">• Repair the problem and then reconnect to the antenna connector.	pp. 82, 83
The communication cannot be established.	<ul style="list-style-type: none">• The antenna is defective or the coaxial cable connector is shorted or cut.	<ul style="list-style-type: none">• Repair the problem and then reconnect to the antenna connector.	pp. 82, 83
The received DSC call content is not printed out.	<ul style="list-style-type: none">• The printer is not correctly connected, or the paper is exhausted.	<ul style="list-style-type: none">• Check the printer connection or paper.	pp. 82, 83
The Voyage Data has not been recorded.	<ul style="list-style-type: none">• The Voyage Data Recorder (VDR) is not correctly connected.	<ul style="list-style-type: none">• Check the VDR connection.	pp. 82, 83
The transceiver is locked up, and does not respond.	<ul style="list-style-type: none">• A software error has occurred.	<ul style="list-style-type: none">• Turn OFF the DC power source, and then turn it ON again.	p. 86
The transceiver does not work.	<ul style="list-style-type: none">• The transceiver's Phase Lock Loop is unlocked.	<ul style="list-style-type: none">• Contact your dealer.	—

• International channels

CH	Frequency (MHz)		CH	Frequency (MHz)		CH	Frequency (MHz)		CH	Frequency (MHz)		CH	Frequency (MHz)	
	Transmit	Receive		Transmit	Receive		Transmit	Receive		Transmit	Receive		Transmit	Receive
01	156.050	160.650	16	156.800	156.800	62	156.125	160.725	77	156.875	156.875	1019	156.950	156.950
02	156.100	160.700	17 ^{*1}	156.850	156.850	63	156.175	160.775	78	156.925	161.525	1020	157.000	157.000
03	156.150	160.750	18	156.900	161.500	64	156.225	160.825	79	156.975	161.575	1078	156.925	156.925
04	156.200	160.800	19	156.950	161.550	65	156.275	160.875	80	157.025	161.625	1079	156.975	156.975
05	156.250	160.850	20	157.000	161.600	66	156.325	160.925	81	157.075	161.675	2019	161.550	161.550
06	156.300	156.300	21	157.050	161.650	67	156.375	156.375	82	157.125	161.725	2020	161.600	161.600
07	156.350	160.950	22	157.100	161.700	68	156.425	156.425	83	157.175	161.775	2078	161.525	161.525
08	156.400	156.400	23	157.150	161.750	69	156.475	156.475	84	157.225	161.825	2079	161.575	161.575
09	156.450	156.450	24	157.200	161.800	70 ^{*2}	156.525	156.525	85	157.275	161.875	--	---	---
10	156.500	156.500	25	157.250	161.850	71	156.575	156.575	86	157.325	161.925	--	---	---
11	156.550	156.550	26	157.300	161.900	72	156.625	156.625	87	157.375	157.375	--	---	---
12	156.600	156.600	27	157.350	161.950	73	156.675	156.675	88	157.425	157.425	--	---	---
13	156.650	156.650	28	157.400	162.000	74	156.725	156.725	--	---	---	--	---	---
14	156.700	156.700	60	156.025	160.625	75 ^{*3}	156.775	156.775	--	---	---	--	---	---
15 ^{*1}	156.750	156.750	61	156.075	160.675	76 ^{*3}	156.825	156.825	--	---	---	--	---	---

*1 Channels 15 and 17 may also be used for on-board communications provided the effective radiated power does not exceed 1 W, and subject to the national regulations of the administration concerned when these channels are used in its territorial waters.

*2 DSC operation only.

*3 The output power of channels 75 and 76 are limited to low power (1 W) only. The use of these channels should be restricted to navigation-related communications only, and all precautions should be taken to avoid harmful interference to channel 16, e.g. by means geographical separation.

14 DIGITAL INTERFACE (IEC 61162-1)

■ I/O Sentences

◇ Version number

IEC61162-1 Ed.4(2010-11)

◇ Input sentences (IEC 61162-1)

RMC, GGA, GNS, GLL, and VTG

◇ Input sentence description

• RMC—Recommended minimum specific GNSS data

\$**RMC, hhmmss.ss, A, llll.ll, a, yyyy.yy, a, x.x, x.x, ddmmyy, x.x, a, a, a*hh<CR><LF>
 1 2 3 4 5 6 7 8 9 10 11 12 13

1	UTC of position fix (000000.00 to 235959.99)	8	Course over ground, degrees true (0.0 to 360.0)
2	Status (A=data valid, V=navigation receiver warning)	9	Date (010100 to 311249)
3	Latitude (0000.0000 to 9000.0000)	10	Magnetic variation, degrees (no use)
4	N/S	11	E/W
5	Longitude (00000.0000 to 18000.0000)	12	Mode indicator (A=Autonomous, D=Differential, F=Float RTK, N=No fix, P=Precise, R=Real Time Kinematic, S=Simulator mode)
6	E/W	13	Navigational status indicator (no use)
7	Speed over ground, knots (0.0 to 100.0)		

• GGA—Global positioning system (GPS) fix data

\$**GGA, hhmmss.ss, llll.ll, a, yyyy.yy, a, x, xx, x.x, M, x.x, M, x.x, xxxx*hh<CR><LF>
 1 2 3 4 5 6 7 8 9 10 11 12 13 14

1	UTC of position (000000.00 to 235959.99)	8	Horizontal dilution of precision (no use)
2	Latitude (0000.0000 to 9000.0000)	9	Antenna altitude above/below mean sealevel (no use)
3	N/S	10	Unit M
4	Longitude (00000.0000 to 18000.0000)	11	Geoidal separation (no use)
5	E/W	12	Unit M
6	GPS quality indicator (1 to 5)	13	Age of differential GPS data (no use)
7	Number of satellites in use (no use)	14	Differential reference station ID (no use)

• **GNS—GNSS fix data**

\$**GNS, hhmmss.ss, llll.ll, a, yyyy.yy, a, c--c, xx, x.x, x.x, x.x, x.x, x.x, a*hh<CR><LF>
 1 2 3 4 5 6 7 8 9 10 11 12 13

1	UTC of position (000000.00 to 235959.99)	8	HDOP (no use)
2	Latitude (0000.0000 to 9000.0000)	9	Antenna altitude, meters (no use)
3	N/S	10	Geoidal separation (no use)
4	Longitude (00000.0000 to 18000.0000)	11	Age of differential data (no use)
5	E/W	12	Differential reference station ID (no use)
6	Mode indicator (N=No fix, A=Autonomous, D=Differential, P=Precise, R=Real Time Kinematic, F=Float RTK, S=Simulator mode)	13	Navigational status indicator (no use)
7	Total number of satellites in use (no use)		

• **GLL—Geographic position – Latitude/longitude**

\$**GLL, llll.ll, a, yyyy.yy, a, hhmmss.ss, a, x*hh<CR><LF>
 1 2 3 4 5 6 7

1	Latitude (0000.0000 to 9000.0000)	5	UTC of position (000000.00 to 235959.99)
2	N/S	6	Status (A=data valid V=data invalid)
3	Longitude (00000.0000 to 18000.0000)	7	Mode indicator (A=Autonomous, D=Differential, N=No fix, S=Simulator mode)
4	E/W		

• **VTG—Course over ground and ground speed**

\$**VTG, x.x, T, x.x, M, x.x, N, x.x, K, a*hh<CR><LF>
 1 2 3 4 5 6 7 8 9

1	Course over ground, degrees true (0.0 to 360.0)	6	Unit N
2	Unit T	7	Speed over ground, km/h (no use)
3	Course over ground, degrees magnetic (no use)	8	Unit K
4	Unit M	9	Mode indicator (A=Autonomous, D=Differential, E=Estimated, M=Manual input, P=Precise, S=Simulator, N=Data not valid)
5	Speed over ground, knots (0.0 to 100.0)		

14 DIGITAL INTERFACE (IEC 61162-1)

■ I/O Sentences (Continued)

◇ Output sentences (IEC 61162-1)

DSC and DSE

◇ Output interval

DSC, DSE: Irregular output (Output immediately after receiving a DSC call.)

◇ Output sentence description

• DSC—Digital selective calling information

\$CDDSC, x, xxxxxxx, xx, xx, xx, x.x, x.x, xxxxxxx, xx, a, a*hh<CR><LF>
 1 2 3 4 5 6 7 8 9 10 11

1	Format specifier (2 digits)	7	Time or Telephone Number (Maximum 16 digits)
2	Address (10 digits)	8	MMSI of ship in distress (10 digits or NULL)
3	Category (2 digits or NULL)	9	Nature of distress (2 digits or NULL)
4	Nature of distress or first telecommand (2 digits or NULL)	10	Acknowledgement (R=Acknowledge request, B=Acknowledgement, S=Neither (end of sequence))
5	Type of communication or second telecommand (2 digits)	11	Expansion indicator (E or NULL)
6	Position or Channel/frequency (Maximum 16 digits)		

• DSE—Expanded digital selective calling

\$CDDSE, x, x, a, xxxxxxx, xx, c--c,, xx, c--c*hh<CR><LF>
 1 2 3 4 5 6 7 8 9

1	Total number of sentences (fixed value)	6	Data set '1' (code field, Enhanced position resolution, Maximum 8 characters), NULL
2	Sentence number (fixed value)	7	Additional data sets*1, NULL
3	Query/reply flag (fixed value A=Automatic)	8	Data set 'n' (NULL)*1
4	Vessel MMSI (10 digits)	9	Data set 'n' (NULL)*1
5	Data set '1' (code field, fixed value 00)		

*1 This transceiver outputs only "Data set 1."

■ Schematic diagram

◇ IEC61162-1 In/Out lines

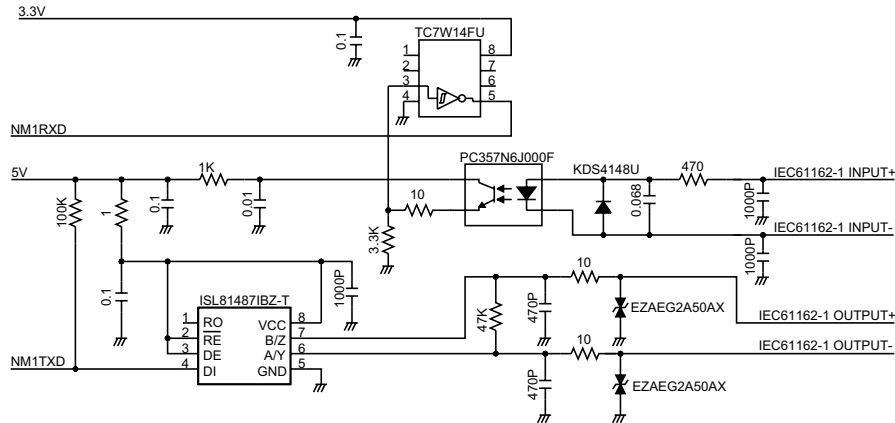

The input circuit is electrically isolated by the PC357N6J000F.

■ Hardware version

The transceiver's hardware version is described on the serial number label, as shown to the right.

■ Software version

You can confirm the transceiver's software version in the Menu screen. See page 81 for details.

Hardware version is described here.



Serial number label

INDEX

A	
Accessory	
Accessory connectors set up	85
Supplied accessories	85
Handset (HS-98)	88
Speaker Microphone	5
Alarm Status	73
Antenna	84
B	
Backlight function	17
Basic operation	13
C	
Call log	
Received Call log	69
Transmitted Call log	70
Channel	
Call channel selecting	13
Call channel setting	14
Channel 16 selecting	13
Channel area	7
Channel list	93
Channel name entry	18
Cleaning	84
Configuration	76, 78
Inactivity Timer	79
Internal Speaker	81
Key Beep	78
MIC Type	81
NMEA Data Output	80
Software Version	81
UTC Offset	78
Connections	82
Power source connection	86
Country code list	iv
D	
Dimensions (GM600/PS-310)	90
Discrete (Alarm Status)	74
Disposal	i
DSC Operation	23
Address ID	23
Distress call	
Call log	69
Regular call	30
Relay call	
With Distress Call Log	39
With DROBOSE	36
Resending	32
Sending	29
Simple call	29
DSC Settings	71
10 Second Delay	72
Alarm Status	73
Automatic Acknowledgement	71
Auto Print	75
Channel 70 Squelch level	74
DSC Loop Test	75
Medical Transports	72
Ships and Aircraft	72
DSC Task mode	27
About "Active" and "Hold"	27
Active window	27
Hold window	27
Software key functions	28
Group ID deleting	24
Group ID entering	24
Individual acknowledgement	
ACK (Able)	59
ACK (New CH)	60
ACK (Unable)	60
Individual ID deleting	24
Individual ID entering	23
Position and time entry	25
Receiving	54
All Ships call	61
Distress acknowledgement	55
Distress Cancel call	56
Distress Relay acknowledgement	57
Distress Relay call	56
Geographical Area call	62
Group call	62
Individual acknowledgement	59
Individual call	58
Medical Transports call	67
Receiving and transmitting	15
Polling Request call	65
Position Report call	64

DSC Operation (Continued)	Dualwatch/Tri-watch	22		
Position Request	Dualwatch	22		
acknowledgement.....	Tri-watch	22		
Position Request Call			H	
Ships and Aircraft call			Handset (HS-98).....	88
Test acknowledgement.....			Connection	88
Test call.....				
Sending	E		I	
Distress call	Emergency	ii	Icon description	iv
Distress acknowledgement	Using channel 16	ii	In/Out lines' specifications	
Distress Cancel call.....	Using digital selective calling (Ch 70) ..	ii	(IEC61162-1)	83
Distress Relay	Explicit definitions	i	Inactivity Timer	
acknowledgement			Distress Related.....	79
Distress Relay call.....	F		DSC Related	79
Distress Relay acknowledgement	Favorite channels	21	Not DSC Related.....	79
Distress Relay call.....	Clearing.....	21	RT Related	80
Non-Distress call.....	Selecting	21	Individual call	
Group call.....	Setting.....	21	Acknowledgement.....	59
Medical Transports call.....	Front panel	2	Receiving	58
All Ships call.....	Function display (Main screen).....	6	Sending	42
Individual acknowledgement	Channel area.....	7	Individual ID deleting	24
Individual call.....	Information area	7	Individual ID entering.....	23
Polling Request	Position and Time area	8	Information area	7
acknowledgement	Status area.....	6	Installation	
Position Request	Software key area	6	Installation note	ii
acknowledgement	Task area.....	6	Mounting the transceiver.....	87
Position Request	Fuse replacement.....	84		
acknowledgement			L	
Position Request call.....	G		License (Operator).....	1
Ships and Aircraft call.....	Group ID deleting	24	License (Ship station).....	1
Test call	Group ID entering.....	24		
Test call acknowledgement				

INDEX

M		P	
Maintenance	84	Panel description	2
Antenna	84	Position and Time area	8
Cleaning	84	Position area	8
Fuse replacement	84	Position and time entry	25
Software maintenance	84	Power source connections	86
Menu	76	Precautions	iii
All Ships call	45	Preparation (MMSI code entry)	9
Compose Distress	30	Priority scan	20
Compose DROBOSE	36	PS-310	86
Compose Non-Distress		Power source connection	86
Individual call	42	Dimensions	90
Group call	46	R	
Position Request call	47	Radio Settings	77
Test call	50	Radio Telephone (RT) mode	14
Medical Transports call	52	Received Call log	69
Ships and Aircraft call	53	Distress message	69
Configuration	76, 78	Other messages	69
Inactivity Timer	79	Receiving	15
Internal Speaker	81	Routine (Alarm Status)	73
Key Beep	78		
MIC Type	81	N	
NMEA Data Output	80	NMEA Data Output	
Software Version	81	DSC Data Output	80
UTC Offset	78	POS Data Output	81
Construction	10	Normal scan	20
DSC Log	69	O	
DSC Settings	71	Operating rules	1
Menu item selecting	12	Options	
Menu screen	10	90	
		Other messages	69

S

Safety (Alarm Status) 73
 Scan operation 20
 Normal scan 20
 Priority scan 20
 Scan types 20
 Starting 21
 Self-Terminate (Alarm Status) 74
 Software key 5
 Software key function selecting 5
 Software key functions in the RCVD
 CALL LOG screen 69
 Software key functions in the TX
 CALL LOG screen 70
 Software maintenance 84
 Speaker Microphone 5
 Specifications 89
 Status area 6

T

Table of contents v
 Task area 6
 Time area 8
 Time entry 25
 Time-out Timer (TOT) function 16
 Transmitted Call log 70
 Transmitting 15
 Tri-watch 22
 Troubleshooting 91

W

Warning (Alarm Status) 73

Count on us!

< Intended Country of Use >

AT BE CY CZ DK EE
FI FR DE GR HU IE
IT LV LT LU MT NL
PL PT SK SI ES SE
GB IS LI NO CH BG
RO TR HR

A-7239D-1EU-②
Printed in Japan
© 2016 Icom Inc.

Icom Inc.

1-1-32 Kamiminami, Hirano-ku, Osaka 547-0003, Japan