

On and Off Grid Interactive Features

AC Coupling

CHILICON POWER MICROINVERTERS AND CP-100 CORTEX GATEWAY SYSTEM

REVISION 1.3 / SEPT 2021

OVERVIEW OF AC COUPLING WITH CHILICON MICROINVERTER SYSTEMS

Chilicon's Frequency-Watt autonomous control mode enables AC-coupling with hybrid battery-inverter devices in **on** or **off** grid applications. Additionally, the Volt-Watt mode allows co-generation with fossil fuel powered backup generators in order to reduce fuel consumption. These modes of operation enable co-installation of PV module powered microinverters with existing battery-hybrid inverters and/or generator systems. The linkage between these systems becomes the AC bus of a critical load panel. By design, cross-brand compatibility is provided due to flexible parameter selection commanded to the microinverters from the CP-100 Cortex Gateway.

These features build on Chilicon's existing Zero-Net Export (Self-Supply Mode) capability which uses CT-Clamps in conjunction with the CP-100 gateway to enable customers to match their own load, but not export to the grid. Unlike Zero-Net export, no CT clamps are required to operate in an AC coupled mode with the Frequency-Watt and Voltage-Watt autonomous control modes. These two modes are 'set and forget' and once programming has been established each microinverter manages its own operation in the selected mode thereafter.

FREQUENCY-WATT MODE

In AC coupled applications utilizing a battery inverter, the microinverter array synchronizes to the utility in the case of hybrid TOU and or peak load shaving. Battery inverters that are also capable of operating off-grid will form the grid voltage and frequency reference to which the microinverter array will synchronize. In this mode of operating, the PV microinverter array will supply the energy to charge the hybrid inverter's batteries when the system load is less than the available PV production. The battery management system in the hybrid inverter can signal to the microinverter array to decrease output in order to decrease the rate of charge into the battery in at least two ways. The first is simply to raise the output line frequency above some grid standard baseline (for example 60.5Hz). The microinverters will sense this and offline their power generation until the

output line frequency is dropped below the trip threshold. The second method is that the hybrid inverter can steadily increase its frequency for the purpose of providing proportional command to the microinverter array such that the microinverter array will proportionally decrease its production level to the extent that an 'equilibrium' between the consumption of the battery and the load matches the production of the PV microinverter array.

In this second approach, the proportional power decrease begins at a designated Start Frequency (**FStart**) and reaches zero output at a designated Stop Frequency (**FStop**). This allows the microinverters to be controlled by the battery inverter such that the batteries maintain optimal charge during daylight running hours. A block diagram of a system that could be configured in either of the two modes above is provide in Figure 1

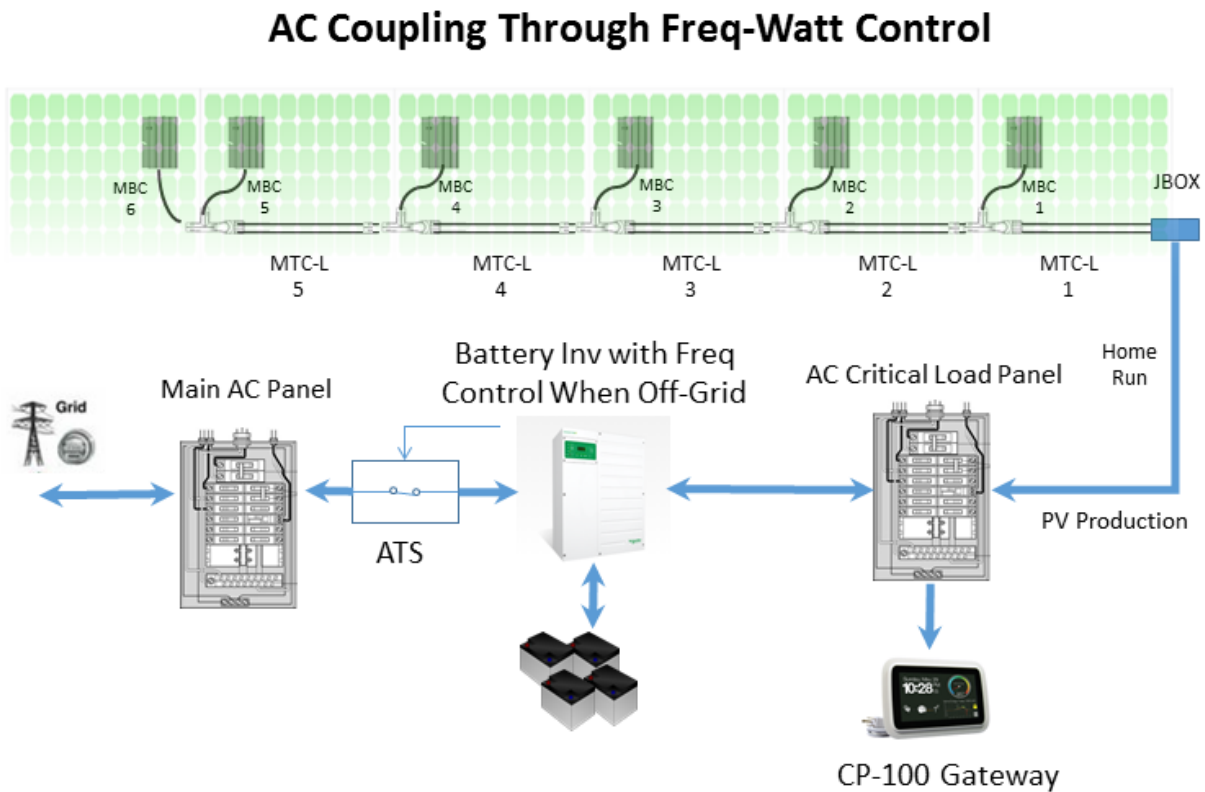
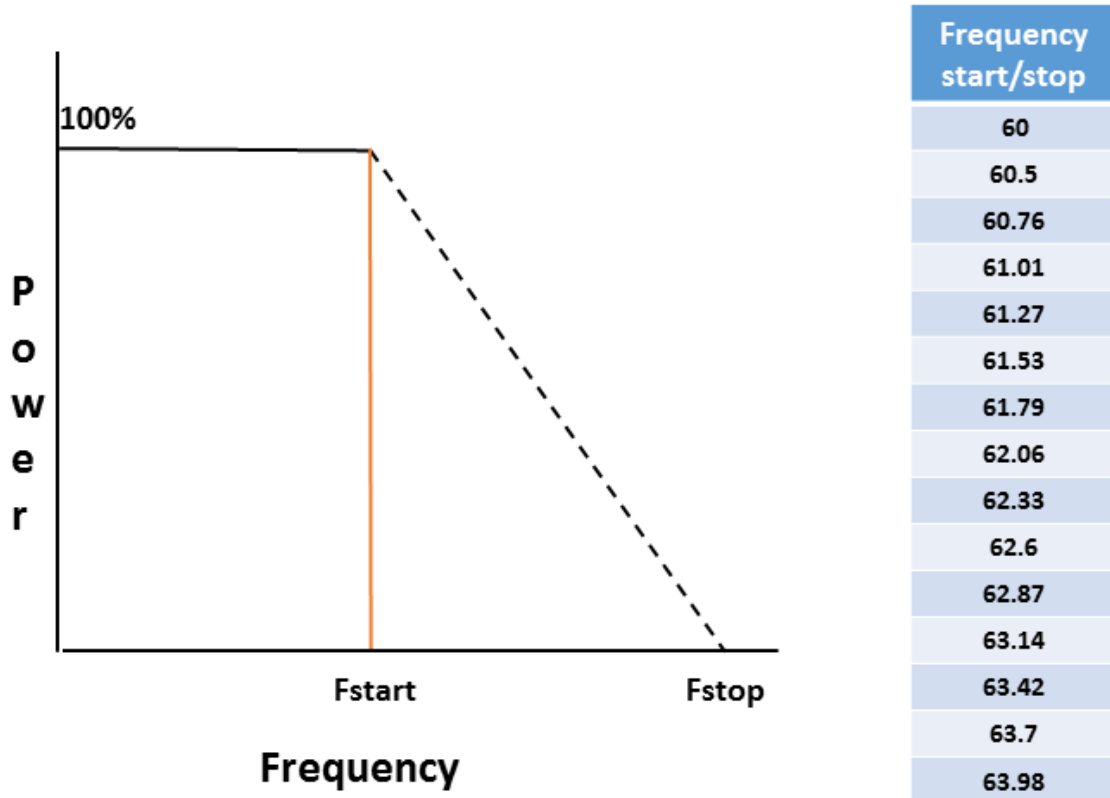

Figure 1. AC Coupling of a Microinverter Array and a Hybrid Battery inverter using Frequency Watt Control.

Figure 2 below describes available values for Frequency Start and Stop values. The corresponding linear roll-off in power between these two frequencies is characterized in the plot. Methodology for programming these values using the CP-100 gateway is provided in a subsequent section below.



Frequency start and stop (F_{start} and F_{stop}) values are sent from the CP-100 Gateway into the inverter array; $F_{stop} \geq F_{start}$.

Figure 2. Available Start and Stop Frequency Values that can be programmed into Chilicon microinverters using the CP-100 Gateway.

VOLT-WATT MODE

To reliably parallel with a generator, both the CP-250E and CP-720 provide a Volt-Watt mode in which line voltage rise is constantly monitored by each inverter and power will be linearly decreased between preset start and stop voltage thresholds. This negative feedback approach prevents an over-voltage condition from developing on an islanded generator controlled system and allows the microinverter array to co-generate (decreasing fuel consumption) without need for a transfer switch between the generator and the array.

AC Coupling Through Volt-Watt Control

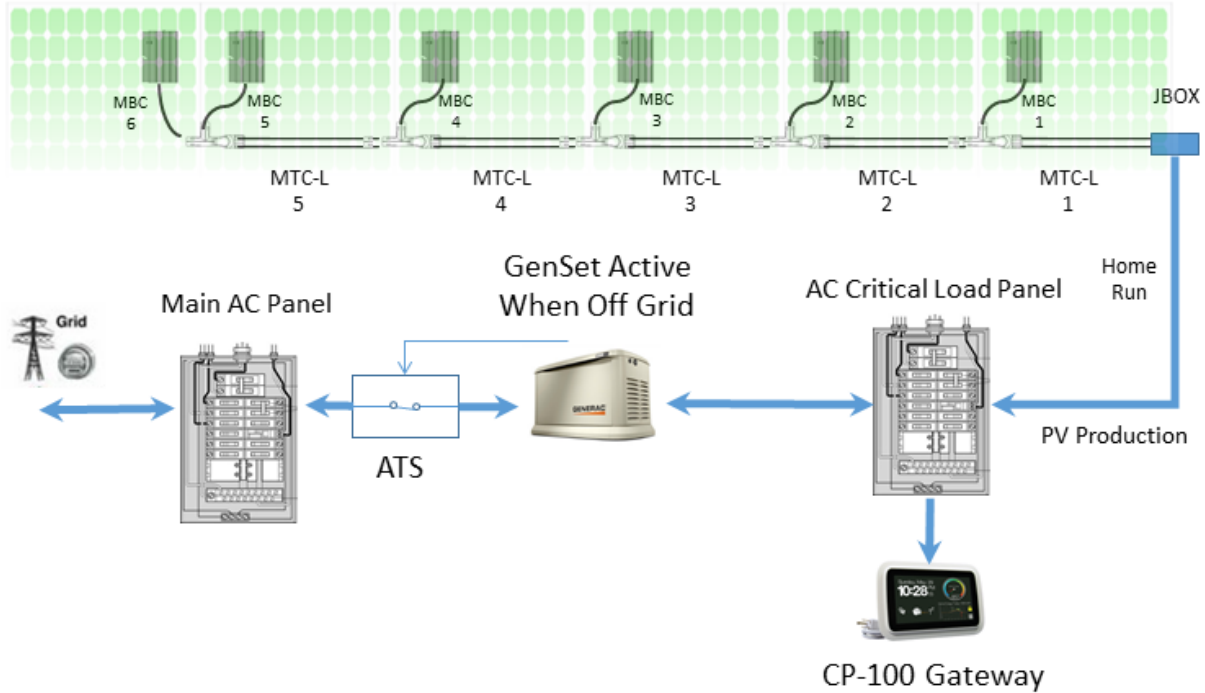

Figure 3. Volt-Watt control between a generator and microinverter array.

Figure 4 below describes four different Volt-Watt modes. Mode 1 is the most aggressive, with power roll-off starting at 243 volts. Mode 4 is the least aggressive, with power roll-off starting at 255 volts. Methodology for programming these values using the CP-100 gateway is provided in a subsequent section below.

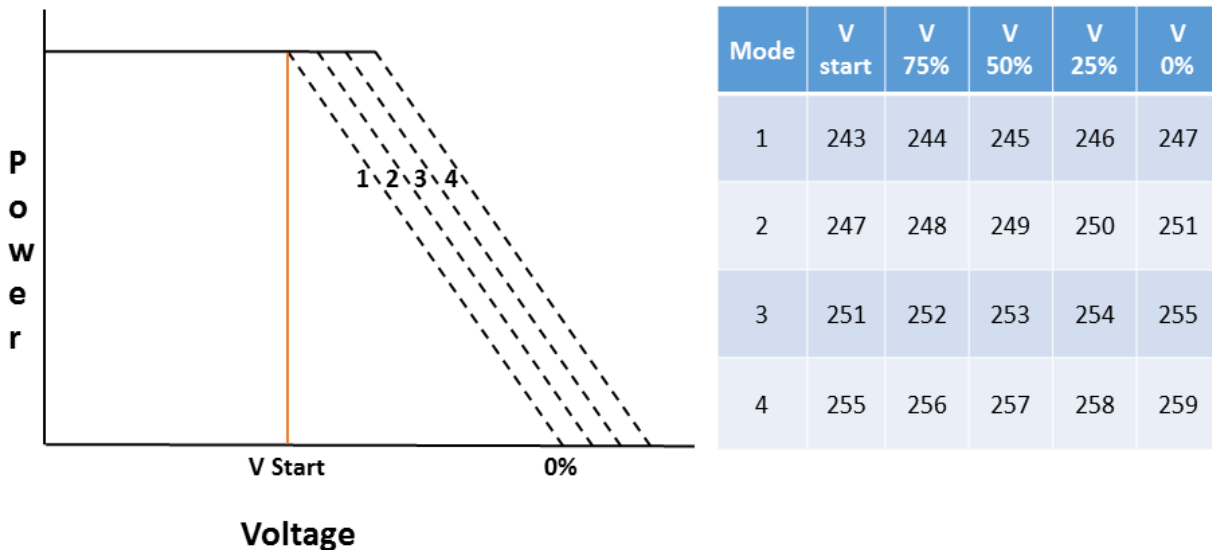

Figure 4. Volt-Watt mode options, modes 1 through 4 show most to leave aggressive volt-rise control.

VAR LOADING CONSIDERATIONS

The generator that the microinverter array AC couples with should be scaled large enough to stably supply the capacitive load of the microinverter array. Each microinverter has a small filter capacitor in its output to smooth off switching noise and meet conducted band electromagnetic compliance. This capacitance becomes 'invisible' once the microinverters start actively exporting power since the output current from each inverter is controlled to have unity power factor. However, if too much reactive load is present on the generator before the inverters start, then the generator can be poorly regulated and present 'jitter' that is difficult for the micros to synchronize with and hence start up.

A popular manufacturer of generators, Generac, recommends that VAR load is held to less than 20% of the Power rating of the generator, or conservatively, less than 10%.

Each microinverter has 1.2uF of capacitance in its output:

$$I_{cap} = 240V * 2 * \pi * 60Hz * 1.2\mu F = 108mA$$

$$VAR = 108mA * 240Volts = 26 Var / inverter$$

These results lead to the values provided in Table 1

Table 1. Generator Sizing Compared to PV Array Sizing

Number of CP250E Microinverters	PV Array AC kW	Total Standby VAR	Minimum Generator kW	Conservative Generator kW
10	2.9	261	1.3	2.6
20	5.8	521	2.6	5.2
30	8.7	782	3.9	7.8
40	11.6	1042	5.2	10.4
50	14.5	1303	6.5	13.0
60	17.3	1563	7.8	15.6
70	20.2	1824	9.1	18.2
80	23.1	2085	10.4	20.8
90	26.0	2345	11.7	23.5
100	28.9	2606	13.0	26.1
150	43.4	3909	19.5	39.1
250	72.3	6514	32.6	65.1

Therefore from the Table 1 we can conclude that a conservative rule of thumb is to scale the generator power capacity in kWatts should be roughly equal to that of the PV Array AC kWatt capacity.

PROGRAMMING THE CP-100 GATEWAY

Both modes can be programmed into any existing or newly installed Chilicon Power microinverter systems using the touch-controlled CP-100 Cortex Gateway. The device can be paired with 60 or 72 cell modules when in normal power point tracking modes with the CP-250E or CP-720 microinverters. 96 and 128 cell pairing is possible with the CP-720 only since the CP-250E is not compatible with 96 or 128 cell modules.

Note that in order to reliably throttle down either the CP-250E or CP-720 microinverter output power, the PV modules must have an operating V_{mp} that does not exceed the stated data sheet V_{mp} of each of these devices with at least 2 volts of margin. So 39 Volt modules are the maximum V_{mp} that should be selected for AC coupled operation. Higher V_{mp} 's (up to 41 volts) can be used per datasheet in non AC-coupled operation. This margin is needed so that the microinverter can get on the 'right-side' of the PV module IV curve to throttle back power.



FREQUENCY WATT PROGRAMMING

Option 1: On-Off Control

Simplest configuration.

Step 1: Ensure the battery inverter raises it's frequency above 60.5 Hz to cause entire microinverter array to disconnect.

Step 2: Disable Rule-21 HLVFRT to force an immediate trip above 60.5Hz (otherwise a 300 second trip delay occurs).

Option 2: Fully Linear Control

Inverters will throttle their power down linearly between F_{start} and F_{stop} as shown in the Frequency-Watt plot above.

Step 1: Ensure the battery inverter raises it's frequency between F_{start} and F_{stop} in order to curtail the microinverters between these limit levels

Step 2: Disable Rule-21 HLVFRT so that indefinite frequency ride through is possible (maximum rule-21 ride through is 300 seconds)

Step 2: Make sure P_{max} has been set to the desired level (and sent)

Step 3: Expand the allowed Frequency operating range to include Freq-Watt Range of interest (the maximum allowed frequency should be higher than the desired F_{stop} frequency)

Step 4: Select and Push Freq-Watt Range of Interest by choosing F_{start} and F_{stop} to match closely with the start and stop frequency control programmed into the battery inverter

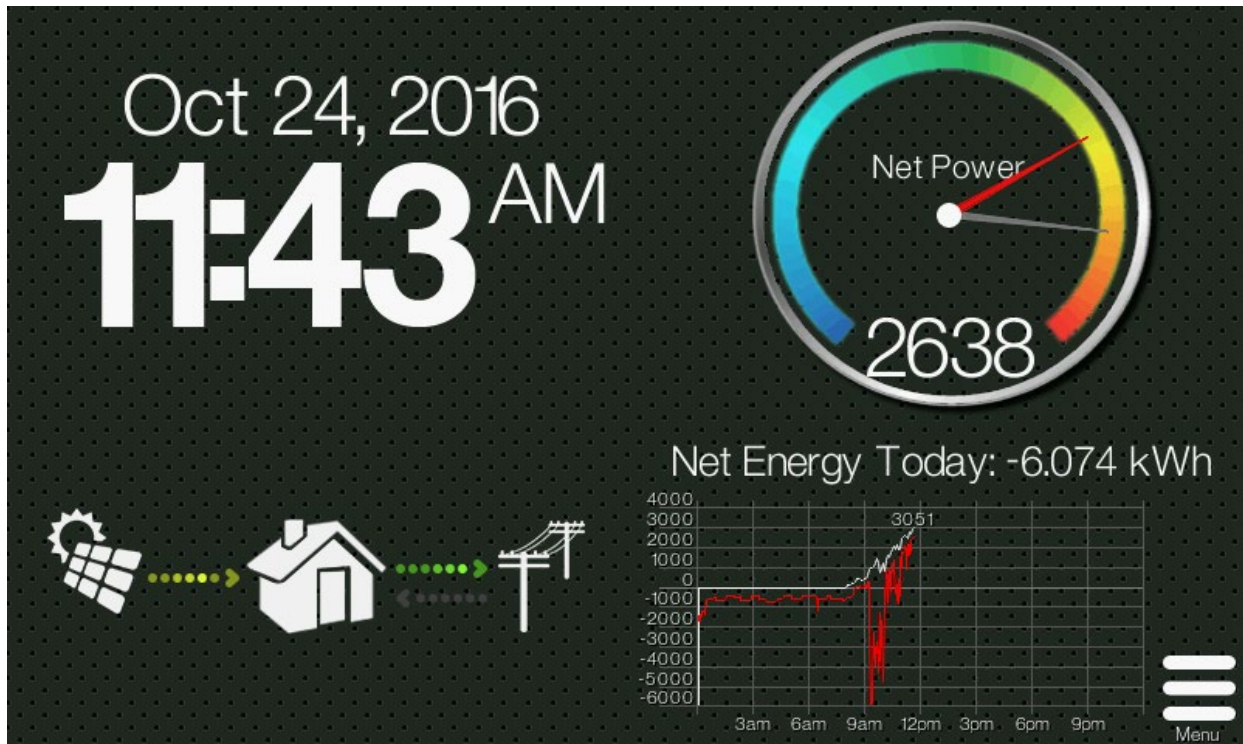

Traverse to the following screens. From the home screen, press the Menu button , then hold the UPPER LEFT CORNER (shown with a green circle), and ENTER PASSWORD “revolution”, which will take you to ‘Developer Main Menu’.

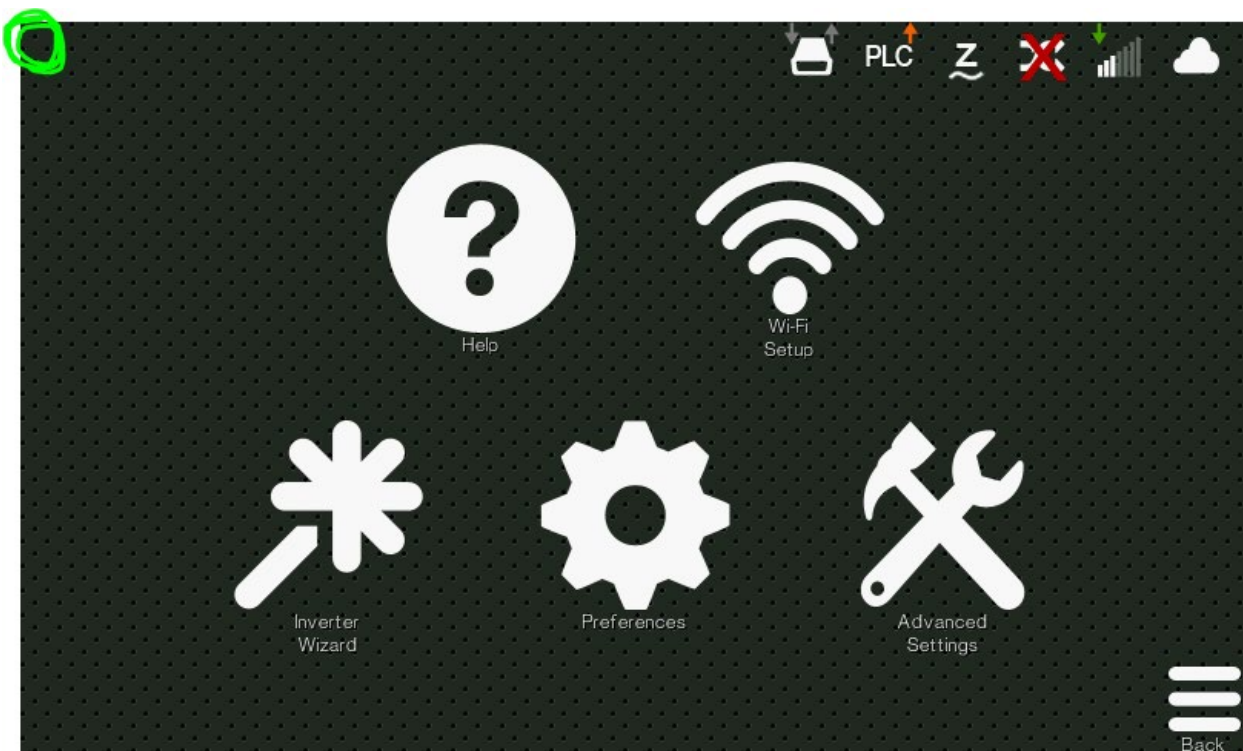

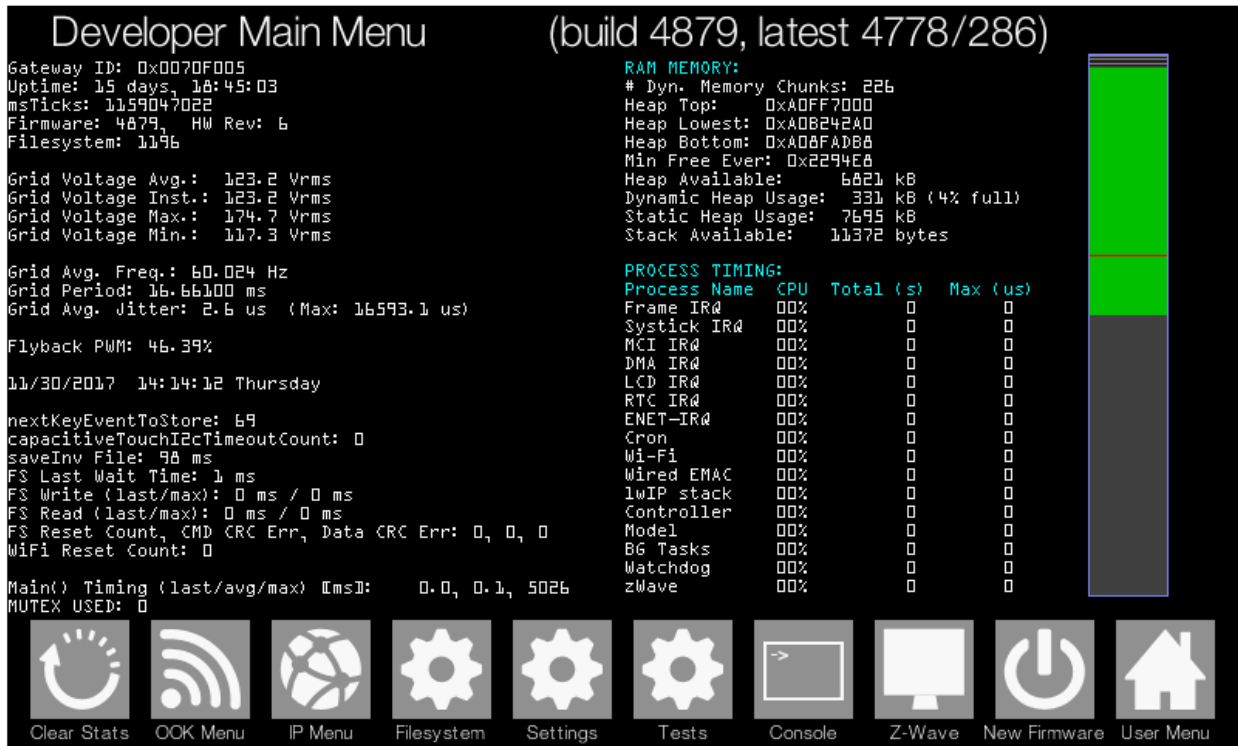

From Developer Main Menu, hit 'Settings' which is the middle icon on the bottom of the screen, then select, 'Page 1'

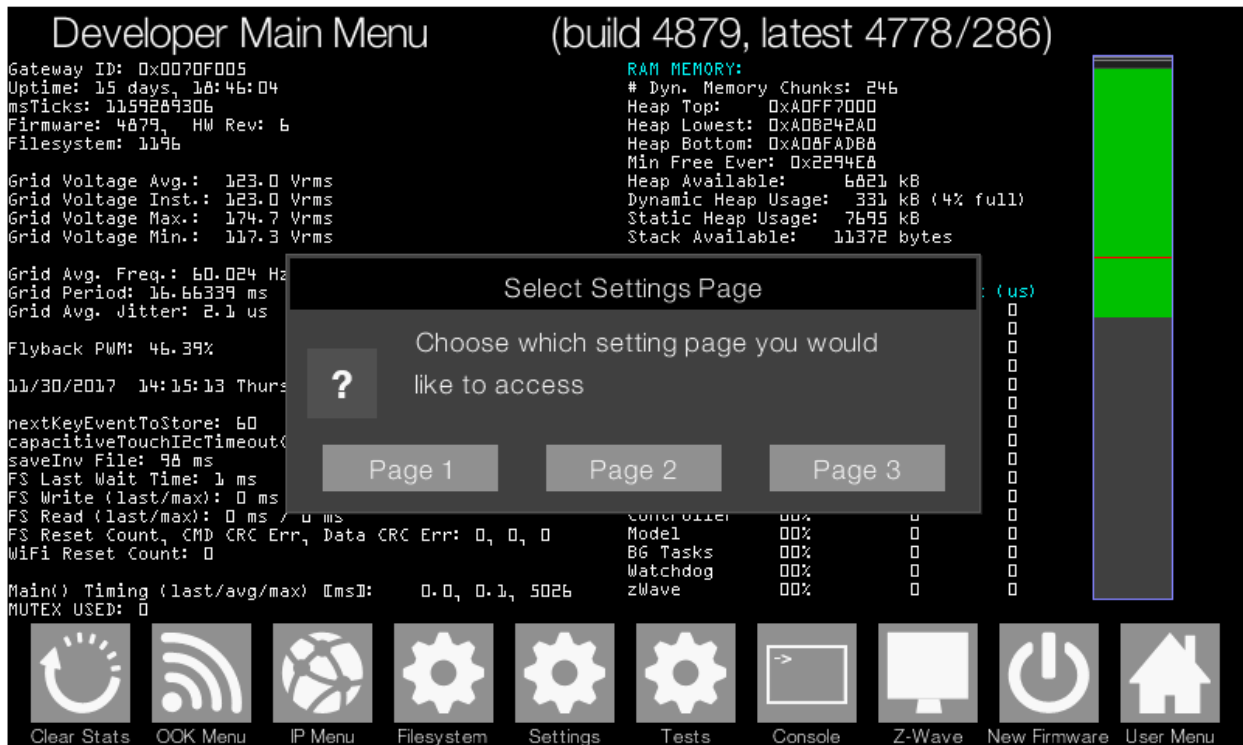

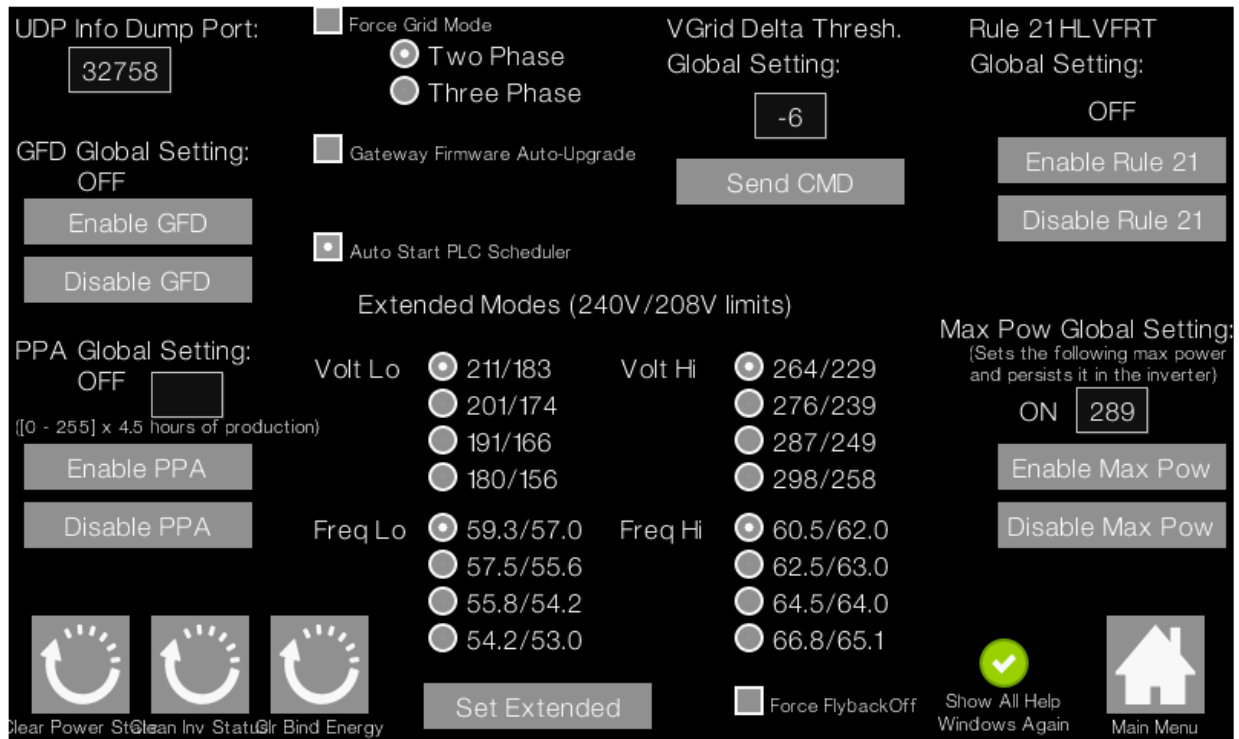

For option 1, simply hit 'Disable Rule 21'. The inverters must be bound to the gateway, the AC breaker must be closed, and it must be day time so that the microinverters are powered. Also confirm that 'Max Pow Global Setting' is at the desired level (289W is the default value).

For option 2,

Step 1: Select the 'Freq Hi' limit level that is high enough to accommodate the Fstop value of interest. For example chose 62.5 Hz if Fstop is below 62.5Hz. After making this selection hit 'Set Extended'.

Step 2: Disable Rule-21 HLVFRT so that indefinite frequency ride through is possible (maximum rule-21 ride through is 300 seconds)

Step 3: Make sure Pmax has been set to the desired level

Next hit 'Main Menu', then again hit 'Settings' and then chose 'Page 2':



OC EVT Threshold: 6

di/dt Threshold: 2.7 A/ms

Volt-Watt Setting: 75% @ 244 V, 50% @ 245 V, 25% @ 246 V, 0% @ 247+ V Enable V-W

Send CTRL2 Control2: 11101101

Freq-Watt Start/Stop: 61.01 62.06 Enable F-W Send Freq-Watt

On/Off Power Control Mode 61.27 FW Upgrade Manual Selection

VGrid Mode Byte (hex): 0 Send 61.53

Power Factor (%): 90 Send PF 61.79

Soft Start Ramp Rate: 1023 Send 62.06

Enable Volt-Var Mode 62.33

62.6

62.87

63.14

63.42

63.7

63.98

Main Menu

Step 4: Select and Push Freq-Watt Range of Interest by choosing Fstart and Fstop to match closely with the start and stop frequency control programmed into the battery inverter. Make sure 'Enable F-W' is selected, then hit 'Send Freq-Watt'.

Return to the main user menu by pressing 'Main Menu' then 'User Menu'.

PROGRAMMING VOLT-WATT CONTROL MODE

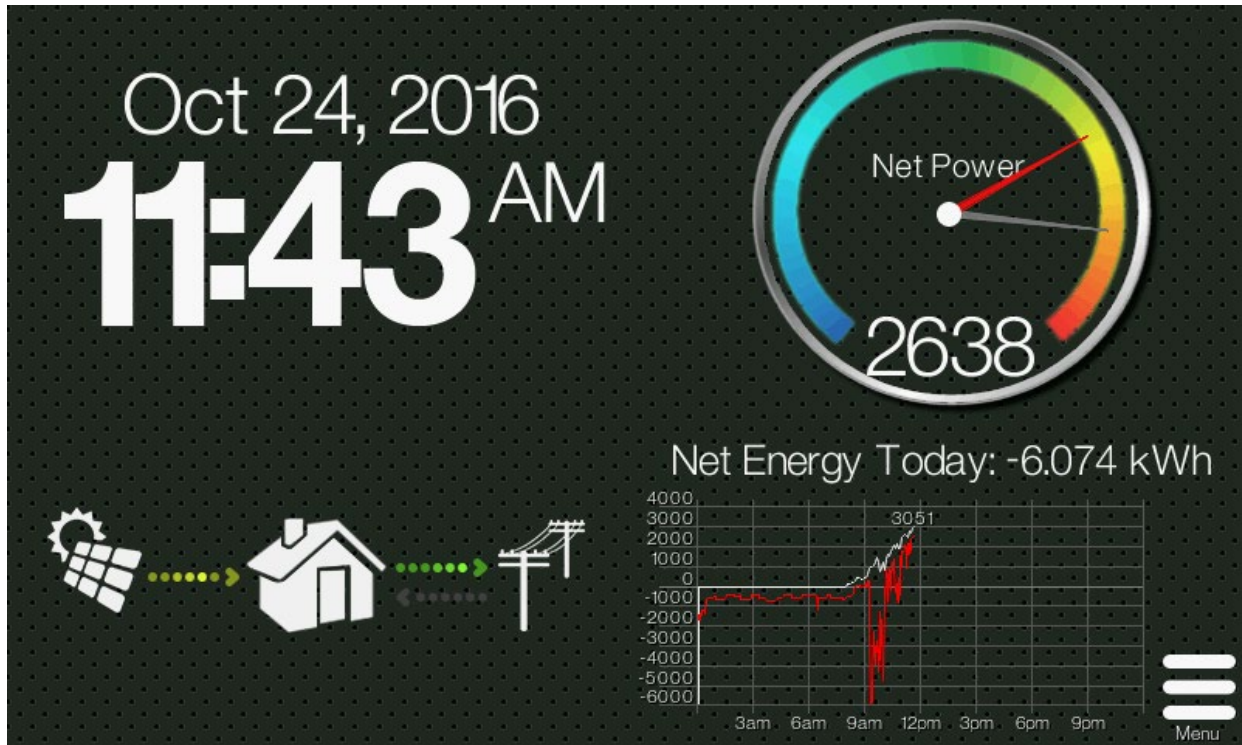

Traverse to the following screens. From the home screen, press the Menu button , then hold the UPPER LEFT CORNER (shown with a green circle), and ENTER PASSWORD “revolution”, which will take you to ‘Developer Main Menu’.

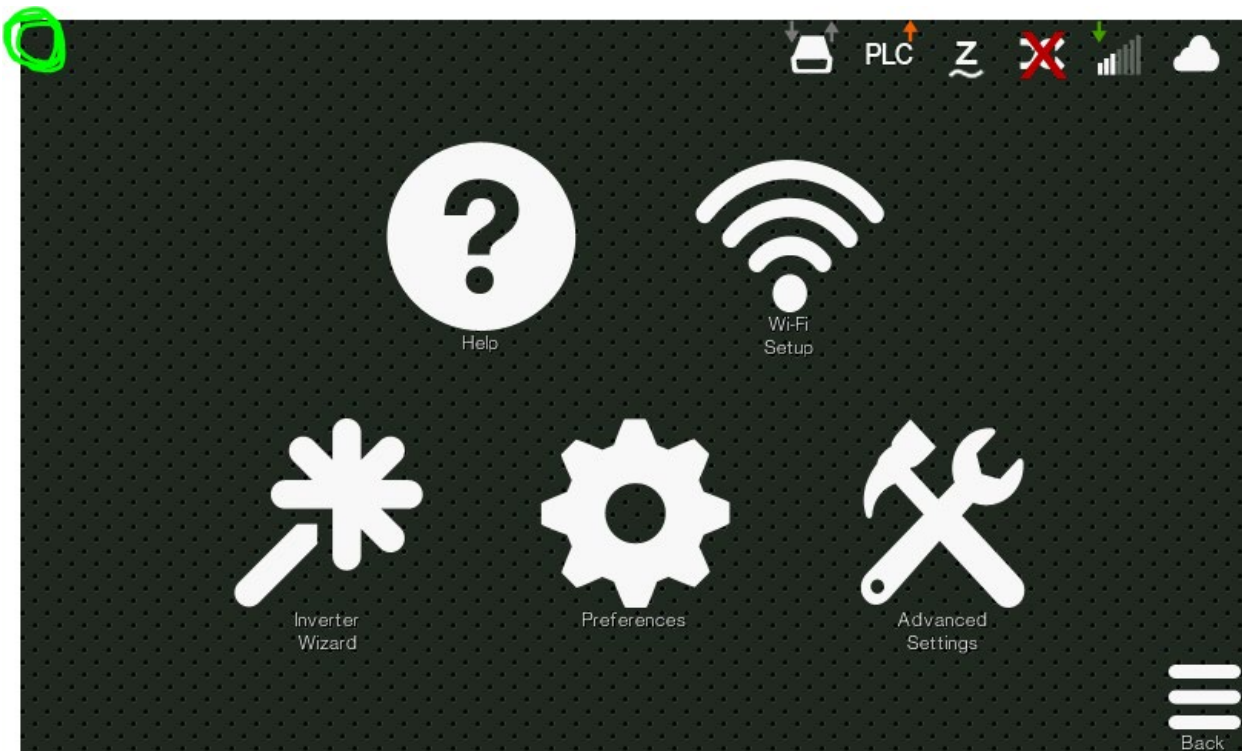

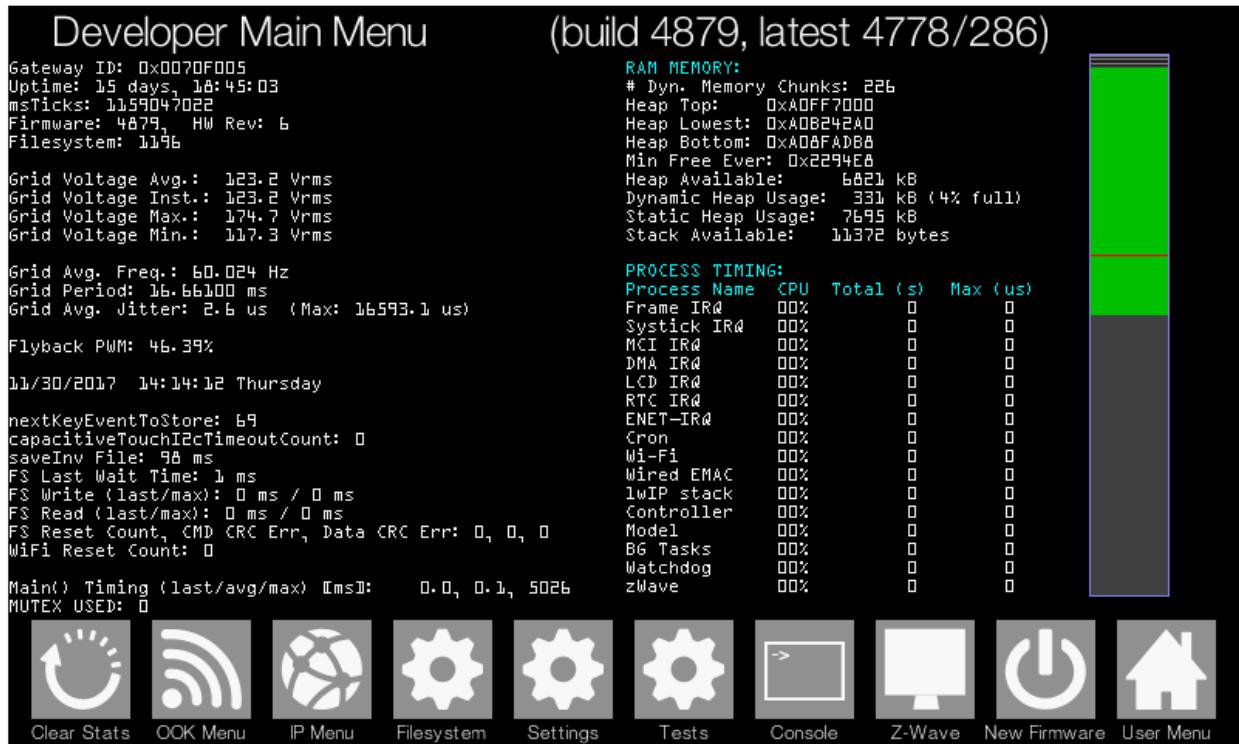

From Developer Main Menu, hit 'Settings' which is the middle icon on the bottom of the screen, then select, 'Page 2'

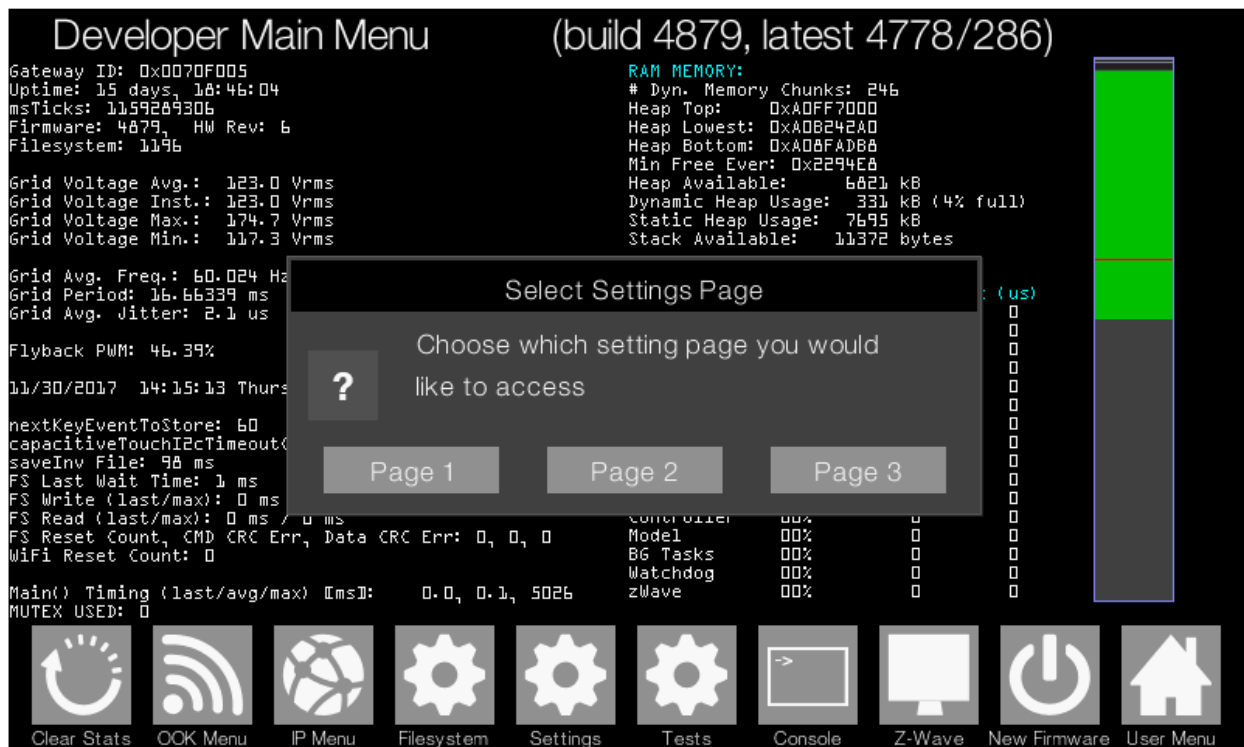

On page 2 of the settings menu, select the Volt-Watt mode of interesting from the drop-down menu, make sure 'Enable V-W' is selected, then press 'Send CTRL2' (which is behind the open drop down on the screen below).

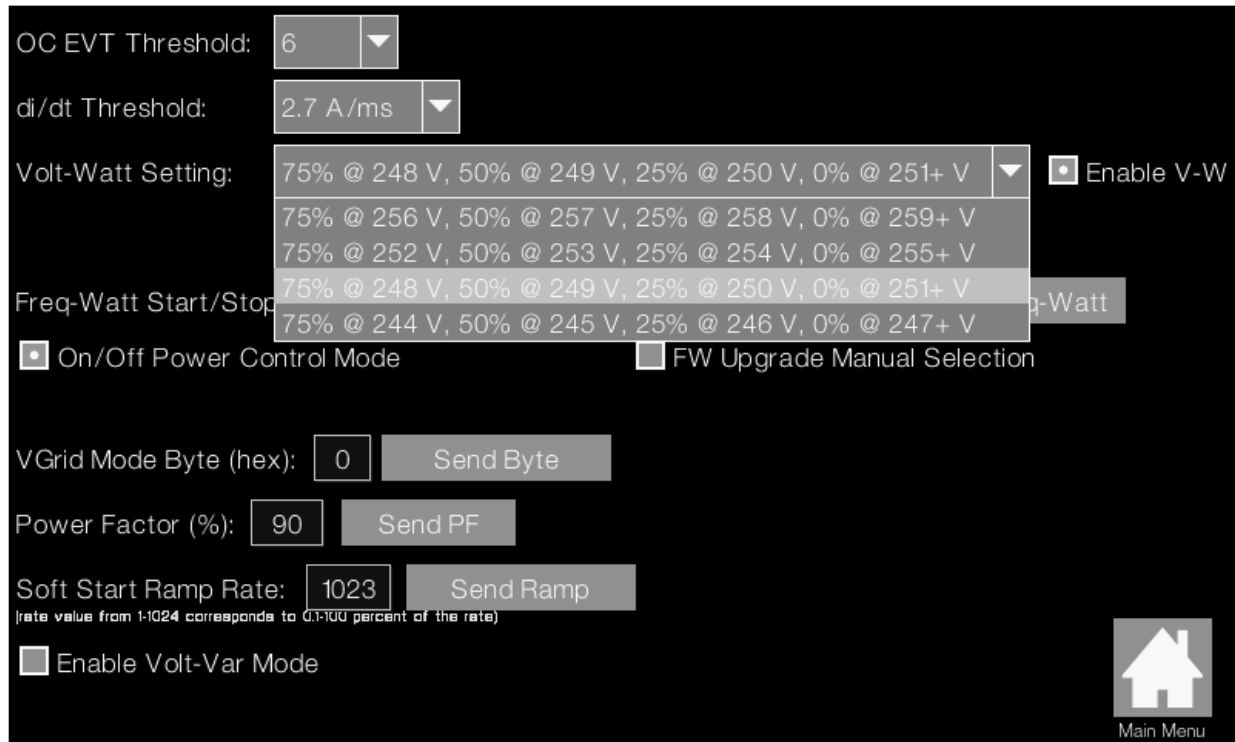

Note that the ranges in the drop down menu shown above are the same as those described in Figure 4.

SUPPORT

Chilicon can set any of these parameters from the cloud if the system is attached to WiFi or Ethernet and registered with the cloud server (using Cloud Setup -> Site Registration). If you have further questions, please email support@chiliconpower.com or contact Chilicon Support at 310-800-1396.