

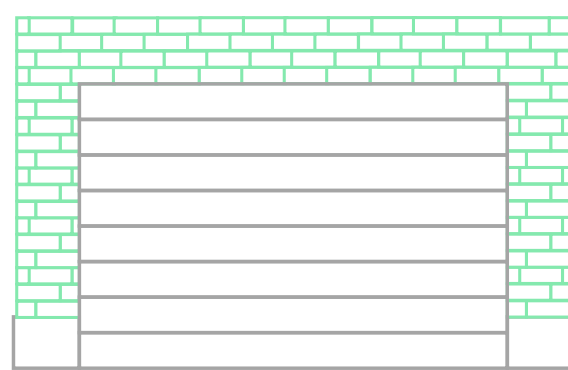

## DO YOU HAVE EMPTY SPACE?



PARKING LOT



GARAGE

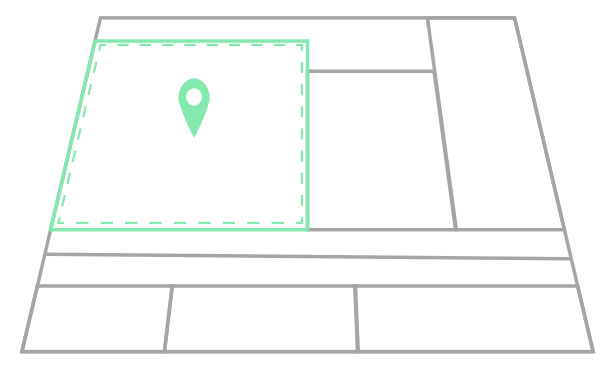

VACANT PROPERTY

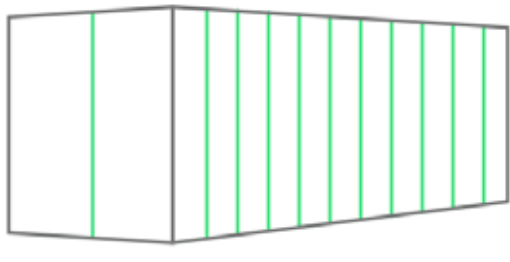

FREIGHT AREA

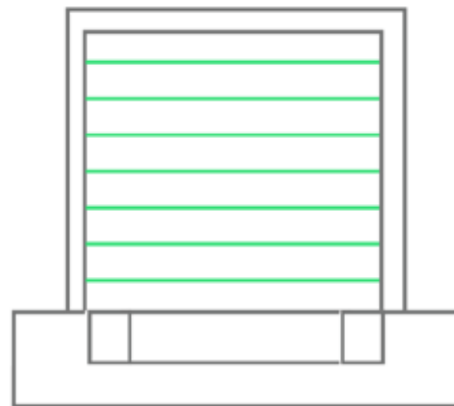

LOADING DOCK

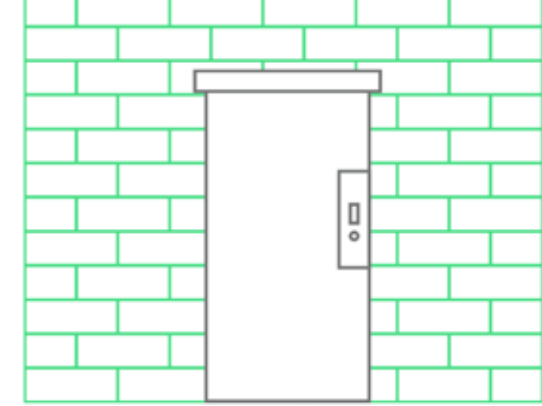

SECONDARY ENTRANCE

## DO YOU HAVE ENOUGH SPACE?

### Min LOT SIZE

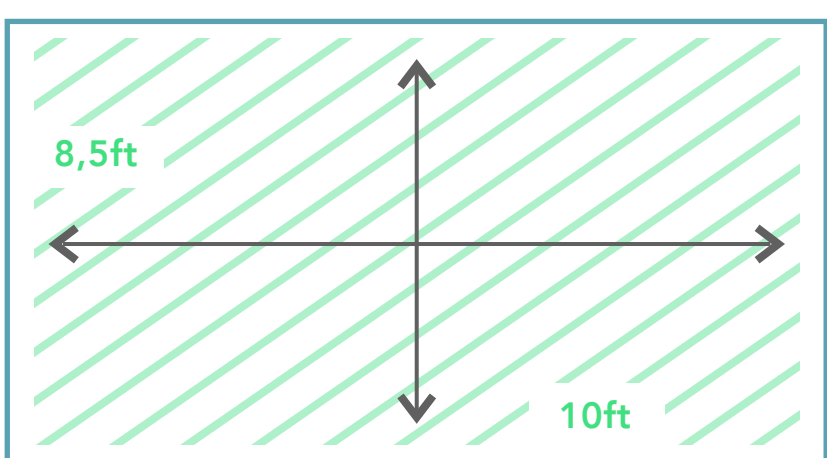

- The bigger the space, the better! It's important to remember, however, that there is a limit to the number of vehicles a single charging station can power.
- Larger spaces, capable of supporting 10+ docks will require multiple charging stations.
- An 8.5ft by 10ft is minimally required.

REMEMBER, EACH GARAGE IS DIFFERENT AND WE CAN BE CREATIVE!

## DO YOU HAVE ENOUGH POWER?

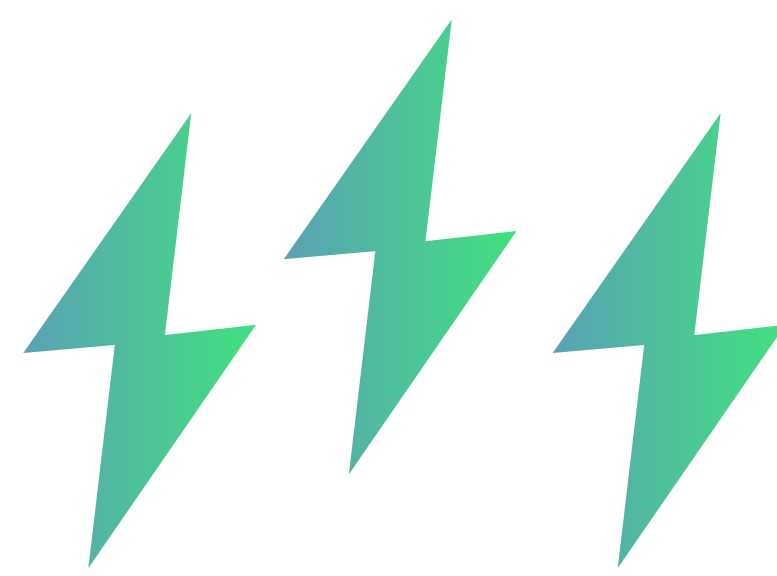

- Operating a single charging station of 185 sq. ft (8.5ft x 10ft) will allow for charging 10 vehicles at once requiring a maximum 1.14 kW/hr.
- Each vehicle requires at least 0.11kW of charging power per hour, and the number of vehicles you can charge at the same time depends on the square footage of our profit.

## HOW TO GET STARTED

INDICATE YOUR LOT SIZE

INDICATE POWER LIMITS

INDICATE YOUR GEOLOCATION

## INDICATE THE DESIRED NUMBER OF VEHICLES TO SUPPORT (5,10,50,100)

<p>5</p>	<p>10</p>	<p>50</p>	<p>100</p>
----------	-----------	-----------	------------

## RECEIVE CHARGING STATION



INSTALL IT

- Choose a well-lit area that the public can access 24/7.
- Our lightweight, easy to install system will have you up and running within minutes of delivery.
- Simply clear space, plug in and start making money.



ACTIVATE IT

- Set it and forget it! Once installed, your job is done.
- Our charging stations require little to no maintenance, which allows you to focus your attention elsewhere.
- Our staff is standing by 24/7 ready to support any of your customer service needs!