

FOREST

DRAPERY HARDWARE



CRS[®]
Channel Rod System

distributed by
horiso[®]
horiso.com.au

CRS[®] Channel Rod System

Product Information

- Elegant and trendy channel rod system.
- Easy and quick assembly.
- Rod available in 20 mm (0,8") and 28 mm (1,1") thickness.
- Bendable, both with an inside and outside corner with a 10 cm (3,9") (20 mm (0,8") rod) or 20 cm (7,8") radius (28 mm (1,1") rod).
- Colours: white, bronze, antique, inox, black and gold.
- The brackets and end caps are available in white, inox, black and gold.
- Length: 5,80 m (19').
- Rod quality: aluminium, chromated, powder coated or anodized.

Applications

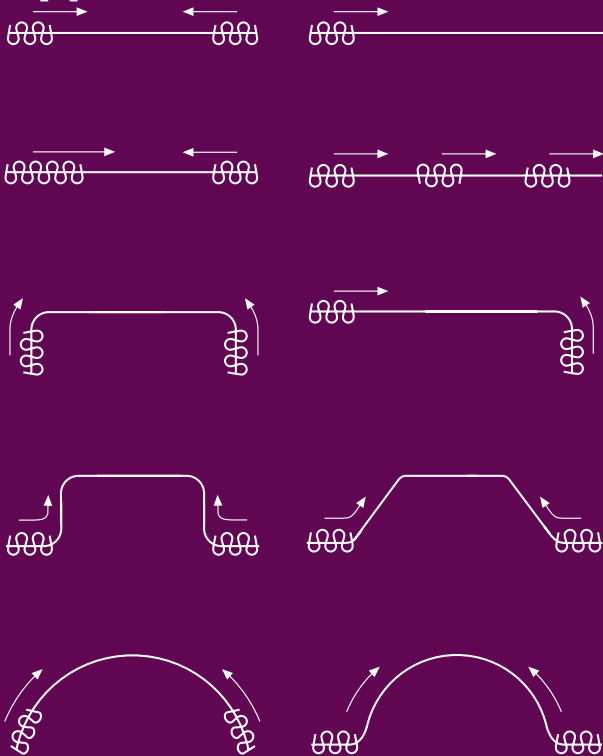

Rail Specifications

- Shown actual size 1:1
- Aluminium Extrusion
- Weight 20 mm (0,8"): 320 gram per meter
- Weight 28 mm (1,1"): 460 gram per meter
- Dimensions: 20 mm (0,8") and 28 mm (1,1")

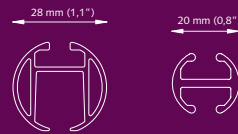

For use in

Domestic and / or project market, or at any location where a high quality, elegant and manually operated channel rod system is requested.

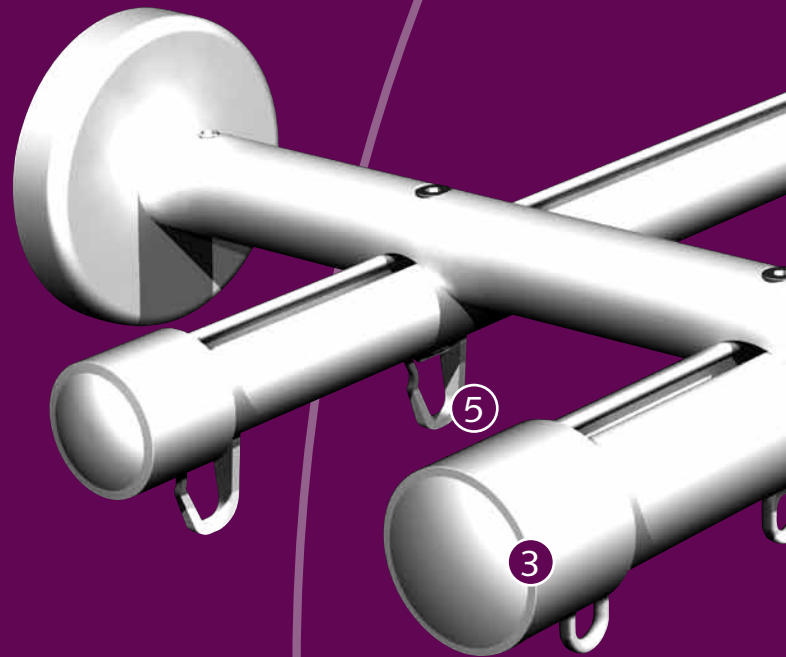

Bending / Curving

The 20 mm (0,8") rod can be curved and reverse curved using a radius of 10 cm (4"); the 28 mm (1,1") rod can be curved and reverse curved by using a radius of 20 cm (8").



Mounting Brackets

- ① CRS Channel Rod 20 mm (0,8")
- ② CRS Channel Rod 28 mm (1,1")
- ③ CRS End Cap
- ④ CRS Carrier
- ⑤ KS Shirrtape Carrier
- ⑥ CRS Wall Bracket Double

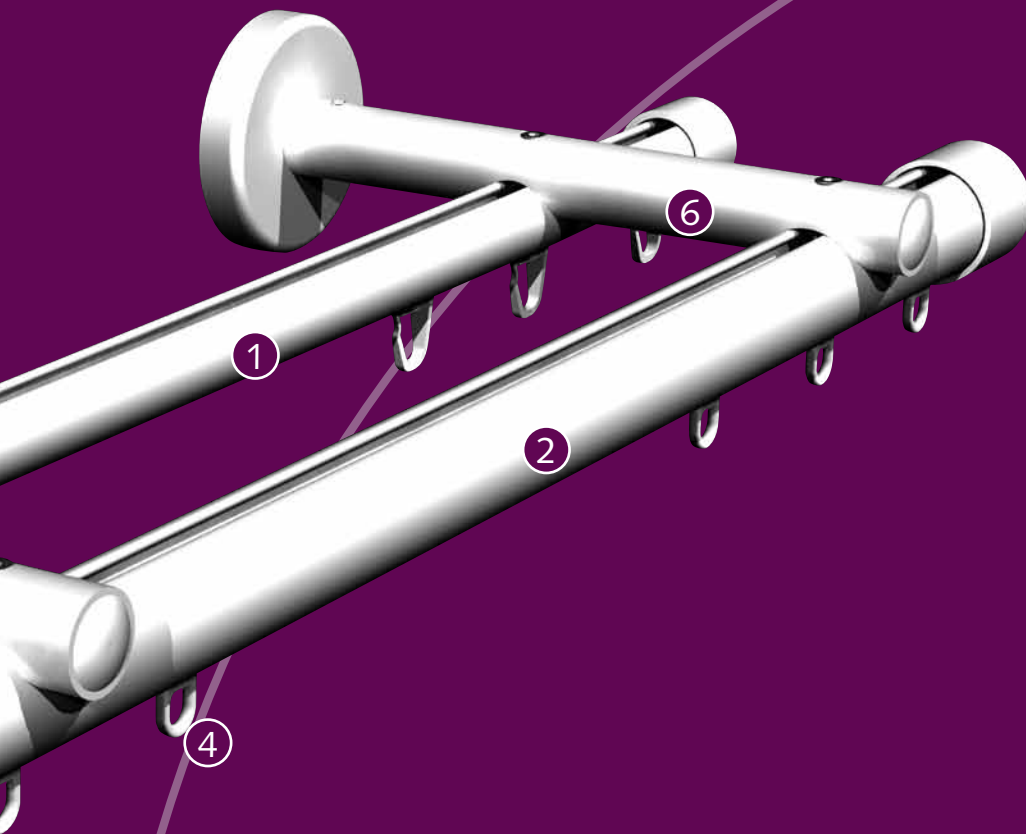

CRS Ceiling Suspension Bracket

4 cm (2") or 10 cm (4").

20 mm (0,8")/ 28 mm (1,1").

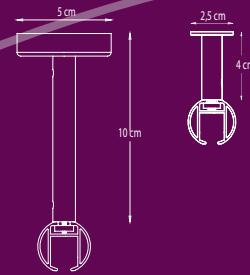

CRS Wall Bracket, single

8 cm (3,1") Ø 20 (0,8")

or 28 mm (1,1").

12 cm (4,7") Ø 20 (0,8")

or 28 mm (1,1").

16 cm (6,3") Ø 20 (0,8")

or 28 mm (1,1").

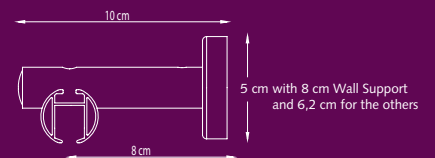

CRS Wall Bracket, double

16 cm (6,3") Ø 20 mm (0,8")

16 cm (6,3") Ø 28 mm (1,1")

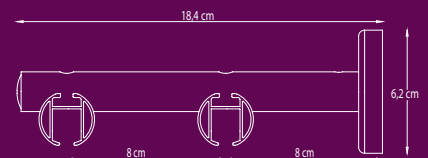

CRS Wall Bracket, double

16 cm (6,3") Ø 20/28 mm (0,8/1,1")



Colours available**01 White, 02 Gold, 03 Inox, 04 Bronze, 06 Black and 09 Antique**

The inox coloured parts are used for both the bronze and the inox coloured rod types.

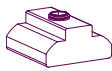
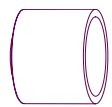
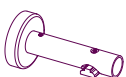
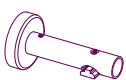
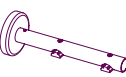
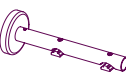
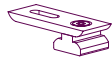
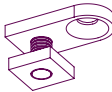
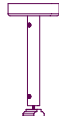
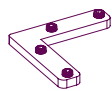
**CRS Channel Rod**Extruded aluminium, chromated, powder coated, 5,80 mtr
Ø 20 mm (0,8") (46.4 mtr/bundle) 580120.580
Ø 28 mm (1,1") (23.2 mtr/bundle) 580128.580**CRS Carrier**UV-resistant plastic, synthetic material. 10 Carriers on a break away strip
5810001000 500/box
Colour: 01**Shirrtape Carrier**Carrier and hook in one "clickable" unit, constructed of UV-resistant plastic. For sew on drapery tape.
10104..000 500/box
Colours: 01,02,03,05.**CRS Metal End-stop with screw**For fixing one carrier as an end stop
Ø 20 mm (0,8") 5816101000
Ø 28 mm (1,1") 5816101001
100/box**CRS End-stop with eye**100/box
5816102000
Ø 20 mm (0,8")
Ø 28 mm (1,1") Short
(with normal CRS Carriers) 5816102002
Ø 28 mm (1,1") Long (with ball bearing) 5816102001**CRS End Cap**58161.020
58161.028
10/box
Ø 20 mm (0,8")
Ø 28 mm (1,1")
Colours: 01, 02, 03, 06, 09**CRS Wall Bracket, single 8 cm (3,15")**For Ø 20 mm rod (0,8") 582008.20
For Ø 28 mm rod (1,1") 582008.28
2/box
Colours: 01, 02, 03, 06, 09**CRS Wall Bracket, single 12 cm (4,72")**For Ø 20 mm rod (0,8") 582012.20
For Ø 28 mm rod (1,1") 582012.28
2/box
Colours: 01, 02, 03, 06, 09**CRS Wall Bracket, single 16 cm (6,29")**For Ø 20 mm rod (0,8") 582016.20
For Ø 28 mm rod (1,1") 582016.28
2/box
Colours: 01, 02, 03, 06, 09**CRS Wall Bracket, double 16 cm (6,29")**Ø 20 mm (0,8") 582216.20
Ø 28 mm (1,1") 582216.28
2/box
Colours: 01, 02, 03, 06, 09**CRS Wall Bracket, double 16 cm (6,29")**Ø 20/28 mm (0,8/1,1") 5822.2028
2/box
Colours: 01, 02, 03, 06, 09**CRS Wall bracket Extension**4 cm (1,58"), 581520.030 10/box
8 cm (3,16") 581510.020
Colours: 02, 03, 06, 09**CRS Ceiling Bracket**Ø 20/28 mm (0,8/1,1"), aluminium 5818003000 100/box
Colours: 03**CRS Ceiling Bracket with hole**white 5818003101
silver 5818003103
100/box**CRS Ceiling Suspension Bracket, Ø 20/28 mm (0,8/1,1")**10 cm (4") bracket 58180.2028
Colours: 01, 02, 03, 06, 09 2/box**CRS Ceiling Suspension Bracket, Ø 20/28 mm (0,8/1,1")**4 cm (1,6") bracket 58181.2000 2/box
Colours: 01, 02, 03, 06, 09**CRS Inside Wall Bracket**For the purpose of installing the rod inside a window frame. Colours: 01, 02, 03, 06, 09 2/box
Ø 20 mm (0,8") 58171.020
Ø 28 mm (1,1") 58171.028**CRS Corner Connector**

90 degrees connector of 5 cm length 5815200007 10/box

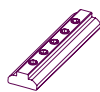
**CRS Rail Connector**aluminium, 6 cm 5815200006 10/box
Colour: 03**Compact Bending House**

For 20 mm (0,8") CRS 1050000000 1/each

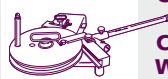
**CRS Bending Wheel** Ø 20 cm (8") 5860000020
For 20 mm (0,8") CRS incl. strips 1/each**Contract Bending Tool**

For 20 and 28 mm (1,1") CRS 2550000000 1/each

**CRS Contract Bending Wheel all-in** Ø 20 cm (8") 5860200020 1/eachFor 20 mm (0,8") CRS, incl. strips
CRS Bending Wheel Ø 40 cm (16") 5860000028
For 28 mm (1,1") CRS, incl. strips 1/each**CRS Bending Strips**1/each
Ø 20 mm (0,8"), 60 cm (23,6") 5860100020
Ø 28 mm (1,1"), 60 cm (23,6") 5860100028
Ø 20 mm (0,8"), 7 m (23') 5860700020
Ø 28 mm (1,1"), 7 m (23') 5860700028**Bending Standard**

Standard for Contract Bending tool 28 mm (1,1") 2560700000 1/each

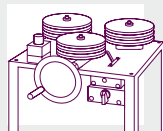
**Electric Powered Bender**

Available in 230 V or 115 V 1060500000 1/each

**Set CRS Bending Wheels**

Ø 20/28 mm (0,8/1,1") 5860702028 1/set