

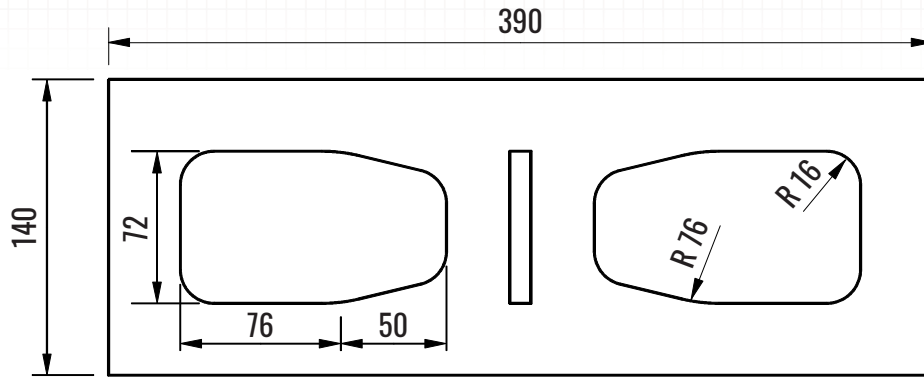

Casey Concrete Ltd. 140 mm (6 in.) SEMI-SOLID BREAKER BLOCK

caseyltd.ca



TOP VIEW

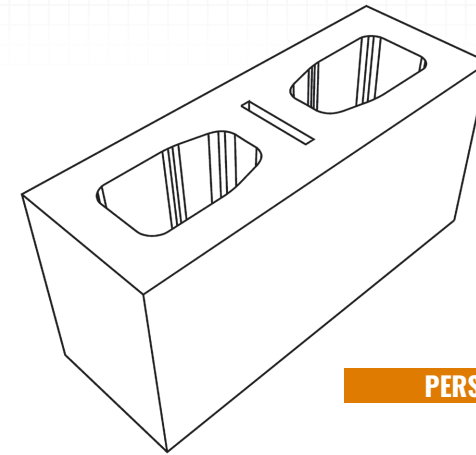

PERSPECTIVE VIEW

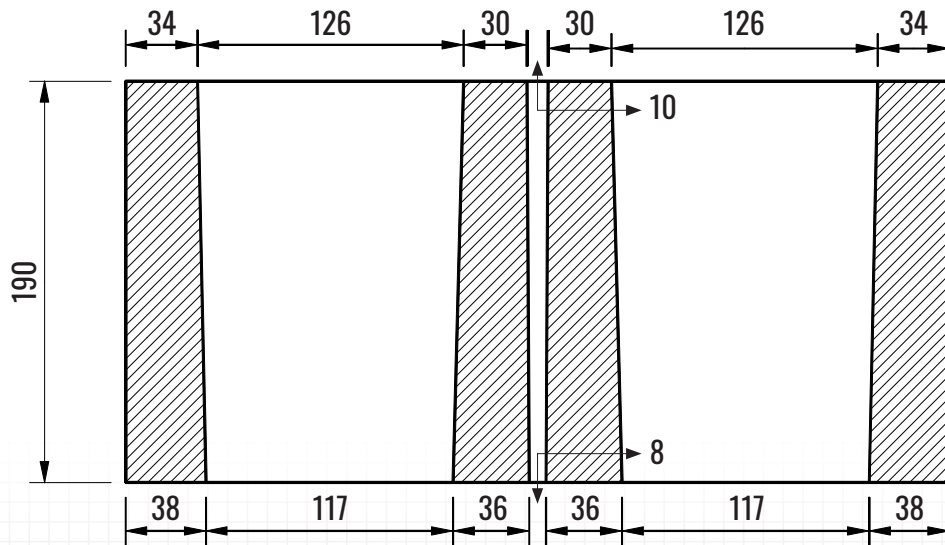

FRONT X-SECTION

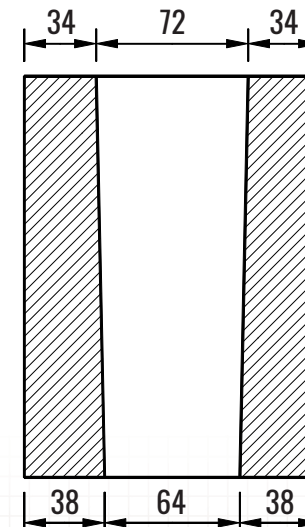

END X-SECTION

PLEASE NOTE: Products are made from natural material sources and therefore color variation and efflorescence may occur.

PACKAGING:

Pieces Per Pallet: 75
 Weight Per Piece: 18.18 kg (40 lbs)
 Weight Per Pallet: 1364 kg (3000 lbs)
 Coverage Per Piece: 0.8 sq.ft (60 sq.ft per pallet)

DIMENSIONAL TOLERANCES:

Meets the requirements of CSA A165.1 Concrete Masonry
 Length: -3 to +3 mm (-0.12 to +0.12 in.)
 Width: -2 to +2 mm (-0.08 to +0.08 in.)
 Height: -3 to +2 mm (-0.12 to +0.08 in.)

PHYSICAL PROPERTIES:

Meets the requirements of CSA A165.1 Concrete Masonry
 Compressive Strength: Min 15 MPa @ 28 Days
 Absorption (%): 8.0% Maximum @ 28 Days