

Standz-Up Ladder Stand Aid

MODEL: PVHA-100

- Designed for two person use
- Works with most ladder stands

Thank you
very much
for choosing



We appreciate
your business!

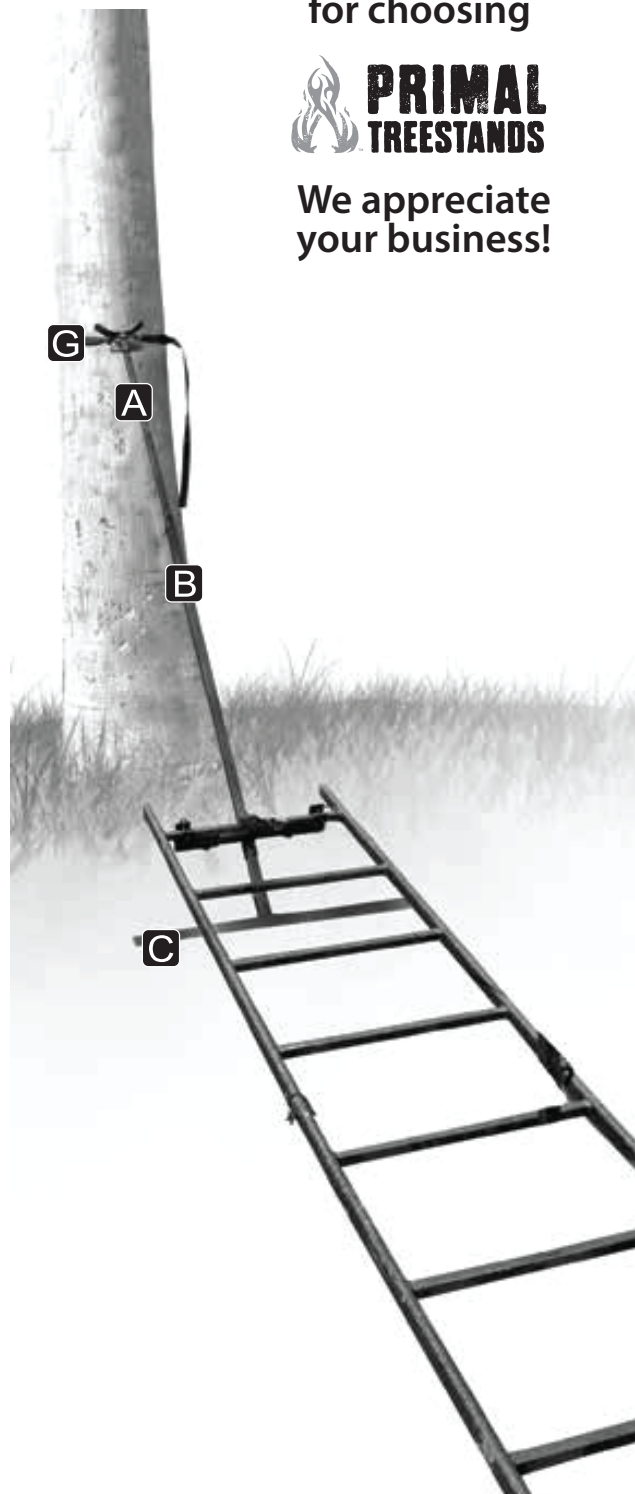

WARNING

SAFETY MUST BE YOUR FIRST PRIORITY WITH THIS PRODUCT

Every year serious injury or death can occur from hunting related accidents. To ensure your safety, please completely read and follow this safety manual and all warning labels before assembling, installing or utilizing this product.

Do not use this product before fully understanding all safety warnings and instructions. If you have questions, are unsure about any information or need additional information concerning your product, contact our customer service department at 1-866-972-6168 or visit www.Primaltreestands.Com. Keep and maintain this safety and instruction manual in a safe location for future reference.

Choosing A Safe Tree

- **ALWAYS** thoroughly inspect the tree before installing your product. **DO NOT** install your **TREE/LADDER STAND** onto any dead or unsafe tree, telephone or utility pole, structural column, or man-made structure. Doing so may result in serious injury or death.
- **ALWAYS** select the proper tree for use with your **TREE/LADDER STAND**. Select a live straight tree that fits within size limits recommended (minimum tree diameter must be no less than 9 inches and maximum of 18 inches.) **DO NOT** rely on a branch for support.
- **DO NOT** select a tree in the dark or choose a tree in close proximity to a fence. You must not have any stumps or rocks beneath your tree.
- **NEVER** use **TREE/LADDER STAND** on a tree that is dead, diseased, leaning or on wet and uneven ground as the tree may fall, break or uproot.
- Your tree must not be wet, icy or slippery or on wet, swampy, or loose ground that allows the tree to be unstable. Check the ground under **TREE/LADDER STAND** to ensure it is firm and level.
- Be sure you have a level stand platform. Your tree must not lean or have any irregular shape.
- Tree must not have any loose or scaly bark or excessive vines, nails, screws, or any other sharp objects protruding that may sever webbing on product. Any surrounding trees must not lean or have dead limbs that may fall onto you or your product.
- **NEVER HURRY!! HURRYING CAUSES ACCIDENTS!!** While climbing a **TREE/LADDER STAND**, make slow, even movements no more than ten to twelve inches at a time. Make sure you have proper contact with tree and/or **TREE/LADDER STAND** every time you move. On ladder tree stand, **ALWAYS** maintain three points of contact with each step up the ladder and **ALWAYS** lean forward as you climb.

Several treestands are equipped with a footrest, armrests and/or shooting rail. Neither the footrest, armrests nor the shooting rail have been designed to support a user's weight. Under **NO** circumstances should you place more than fifteen (15) pounds of weight on these structures. Doing so will put the user in serious risk of injury or death.

Proper Care and Maintenance:

- Inspection for defects (damage, rot, corrosion, cracks, freezing, excessive heat, etc.) before every use is required. Do not use if damage is detected or suspected.
- We recommend replacing all hardware/cables/nuts/bolts/clips on your tree stand every two (2) years or sooner if inspection finds it necessary. Use only Primal Vantage approved replacement straps and parts. Use of any other straps or parts, will be viewed as a modification to the product. Any modification will void the warranties and relieve Primal Vantage from all liabilities. Failure to follow these instructions may result in serious injury or death.
- **DO NOT** overtighten the hardware. **DO NOT** use a socket wrench. This can lead to structural damage and may negatively affect the performance of your stand. Failure to follow these instructions may result in serious injury or death.
- All photos are taken from the front view unless otherwise noted.
- In most cases, bolts come with two nylon washers. One washer will be placed against the bolt head the other washer will be placed against the nut.

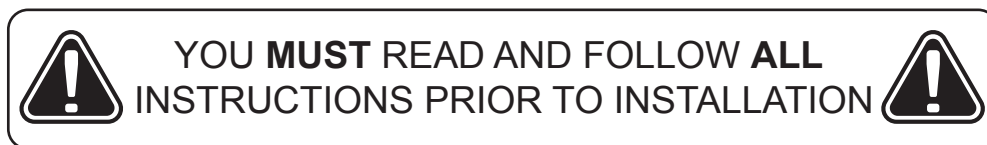



Standz-Up Ladder Stand Aid

MODEL: PVHA-100

- Designed for two person use
- Works with most ladder stands

PARTS LIST

- A** 1 Ladder Stabilizer Inner BarPart # PISB-100
- B** 1 Ladder Stabilizer Outer BarPart # POSB-100
- C** 1 Ladder Stabilizer BasePart # PSB-100
- D** 1 Center Attachment Bracket.....Part # PCAB-100
- E** 1 L. Ladder Attachment Bracket.....Part # PLAB-100
- F** 1 R. Ladder Attachment Bracket.....Part # PRAB-100

HARDWARE BOX P/N 100H

- G** 1 Ratchet Strap Part # PRC-100
- H** 2 L/R Bracket KnobsPart # PBN-100
- J** 2 M8 Quickclips.....Part # 1615
- K** 1 M6 Quickclip.....Part # PQC-100
- 45** 3 M8x45mm Bolts.....Part # 1245

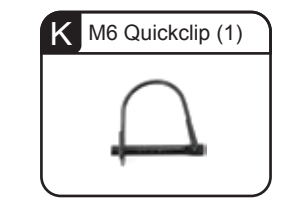
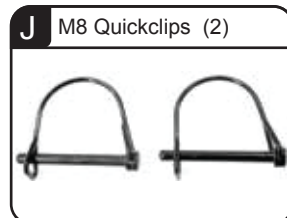
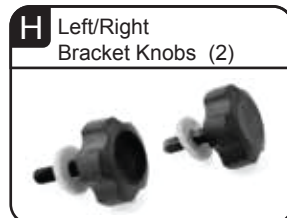
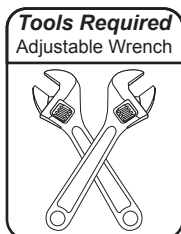
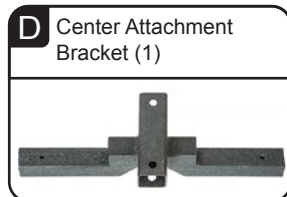
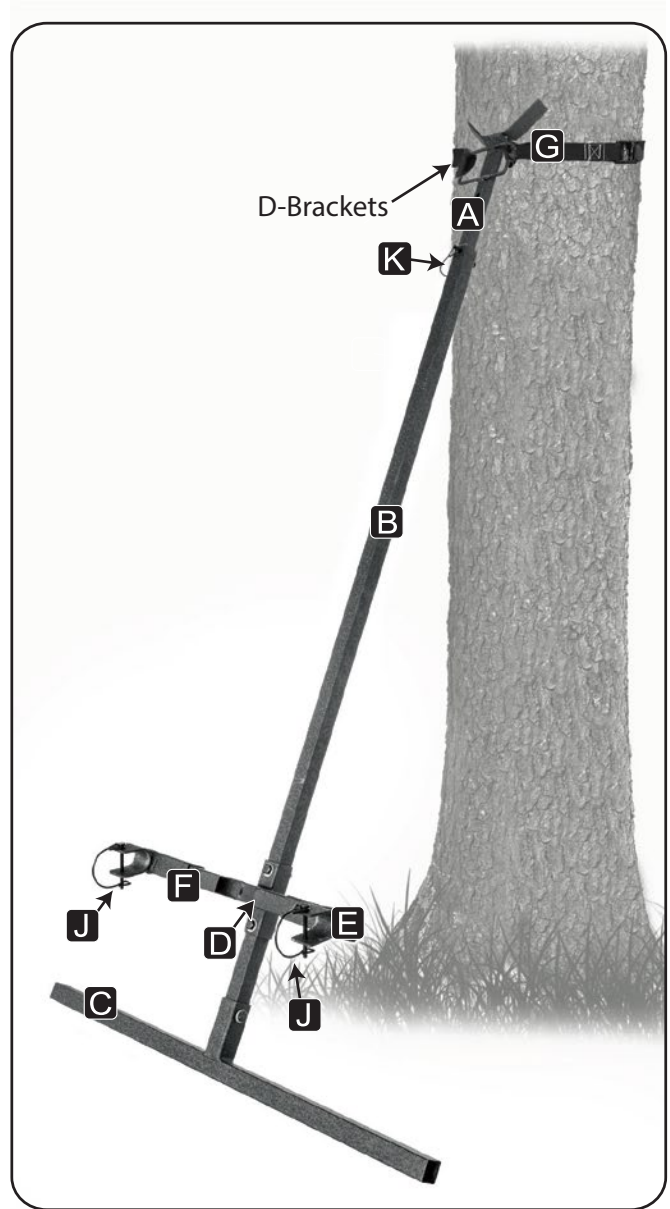
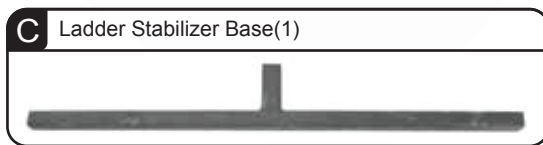
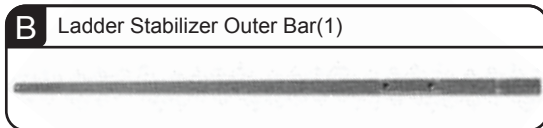
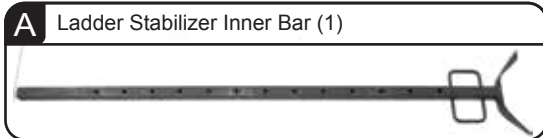

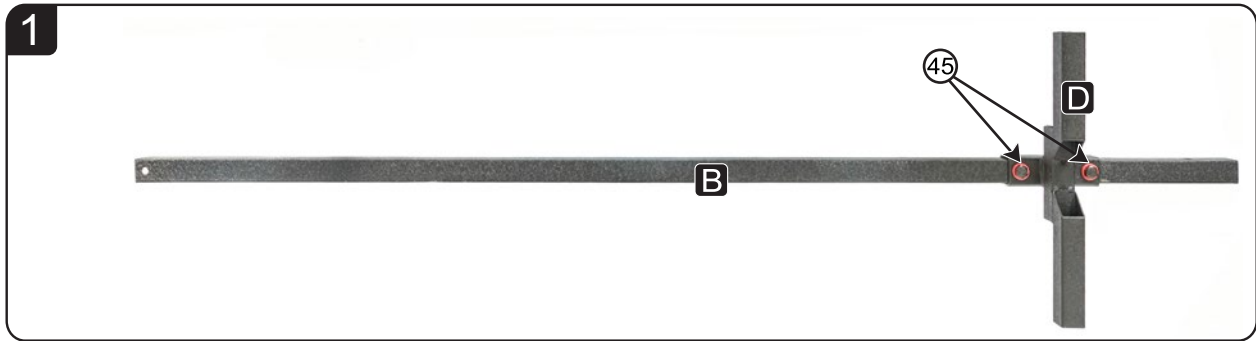

1 Slide Center Attachment Bracket **D** onto lower end of Ladder Stabilizer Outer Bar **B** Lining up connection holes, attach using **2-M8x45mm bolts** (45)

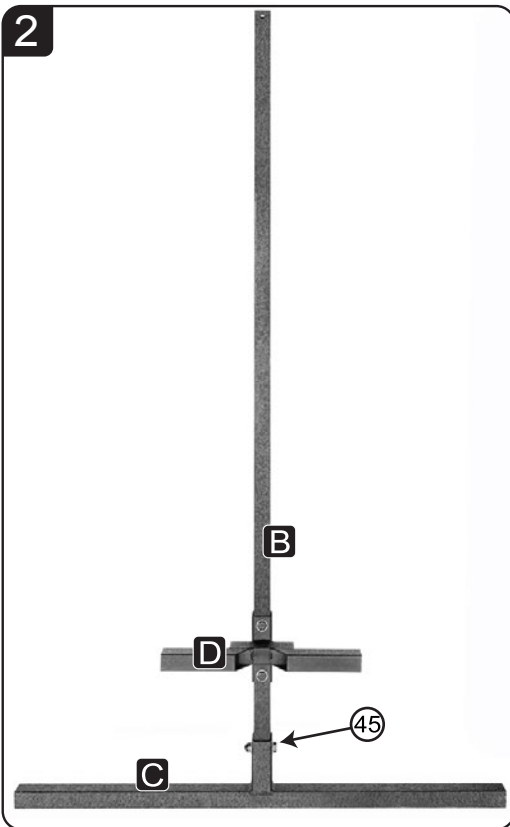

2 Slide Ladder Stabilizer Outer Bar **B** assembly onto Stabilizer Base **C**. Attach using **1-M8x45mm bolt** (45)

3a: Slide Right Ladder Attachment Bracket **F** and Left Ladder Attachment Bracket **E** onto either side of Center Attachment Bracket **D**. **NOTE:** Both Right and Left Ladder Attachment Brackets must be facing you and angled down.

3b: Secure both Right and Left Ladder Attachment Brackets **E** and **F** to Center Attachment Bracket **D**, using Left/Right Bracket Knobs **H**. **NOTE:** Right and Left Ladder Attachment Brackets are designed to slide inward and outward to variable widths: A minimum of 10" and maximum of 15" (as shown Below).

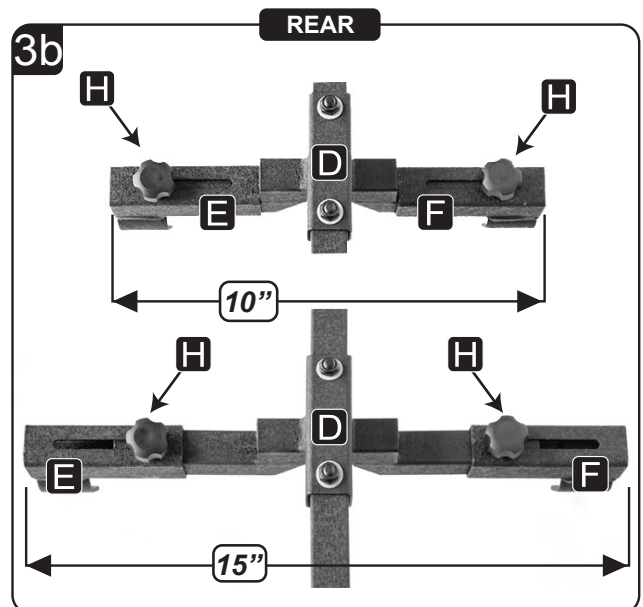
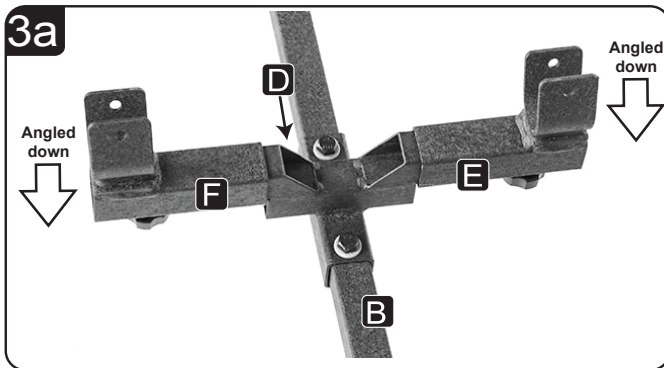

4 Fit **M8 Quickclips J** onto each Right and Left Ladder Attachment Bracket **E** and **F**. **NOTE:** These Quickclips will be used to secure the base of your ladder stand in place during hoisting procedures. **ALWAYS** store Quickclips here when not in use. **NEVER** use this product without these Quickclips.

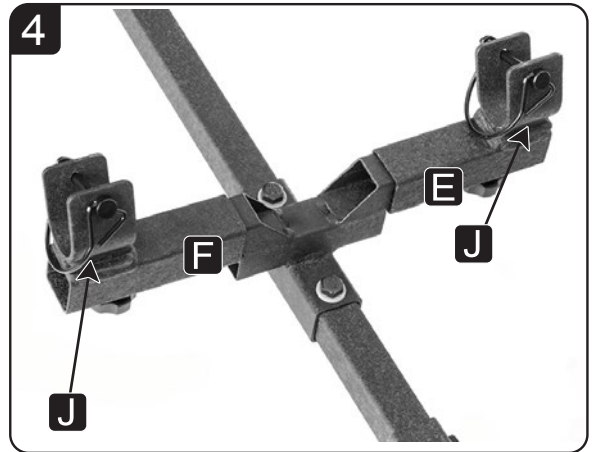

5 Slide Ladder Stabilizer Inner Bar **A** into Ladder Stabilizer Outer Bar **B**. **NOTE 1:** The D-Brackets on Ladder Stabilizer Inner Bar **A** should face **FRONTWARD** towards Ladder Brackets. **NOTE 2:** This Stabilizer Bar is designed to height adjust. Secure in place using **1-M6 Quickclip K** (as shown Below). **NEVER** use this product without this Quickclip.

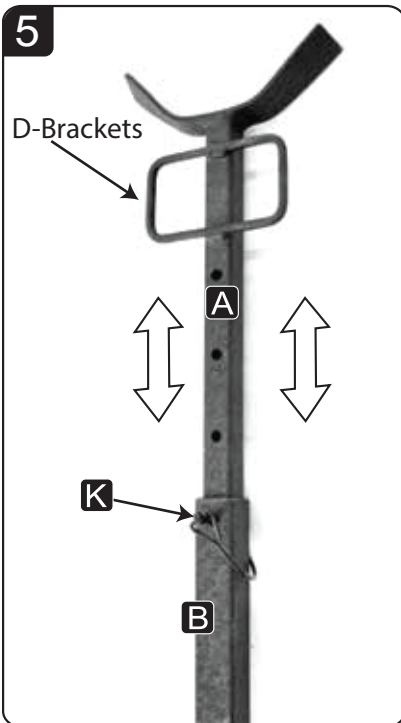

6 Attach Ratchet Strap **G** to right and left sides of the D-Brackets on Ladder Stabilizer Inner Bar **A**. Thread the Ratchet Strap **G** webbing loops around D-Bracket on Ladder Stabilizer Bar **A**. Feed ratchet back through loop to attach. Repeat process for strap on other side. See "Ratchet Strap Instructions" (Below) for correct usage.

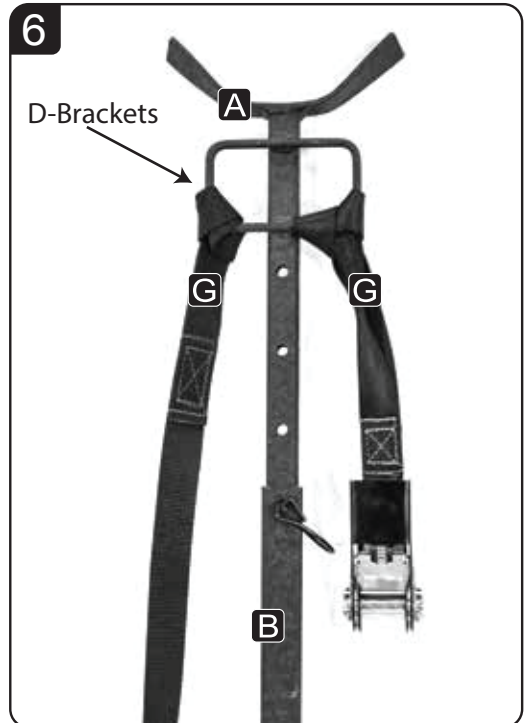

⚠ WARNING
MAKE SURE ALL BOLTS ARE TIGHT BEFORE PROCEEDING TO INSTALLATION

Detailed Ratchet Strap Instructions



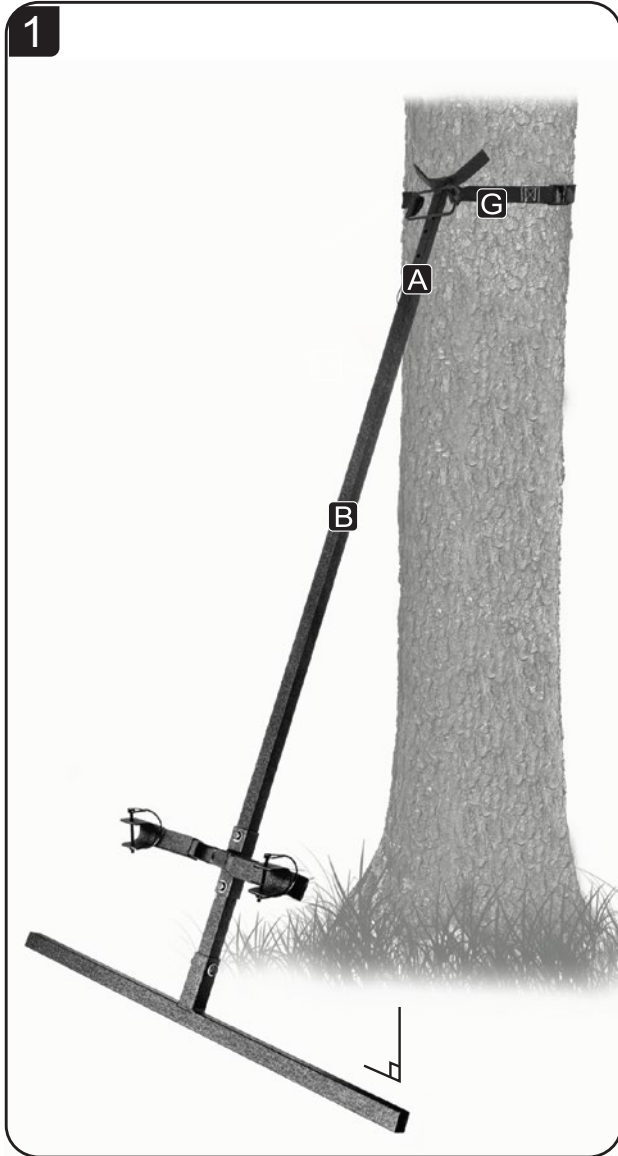

1 Follow your ladder stand manufacturer instructions in locating an appropriate tree. Finding as level ground as possible, lean the Ladder Aid Stabilizer assembly against the tree so that the Ladder Attachment Brackets are facing OUTWARD. Adjust the Inner Stabilizer Bar **A** to a correct height and leaning angle to work best with your ladder stand.

2 Secure Ladder Aid Inner Stabilizer Bar **A** to tree using Ratchet Strap **G**. See "Ratchet Strap Instructions" for correct weaving and usage.

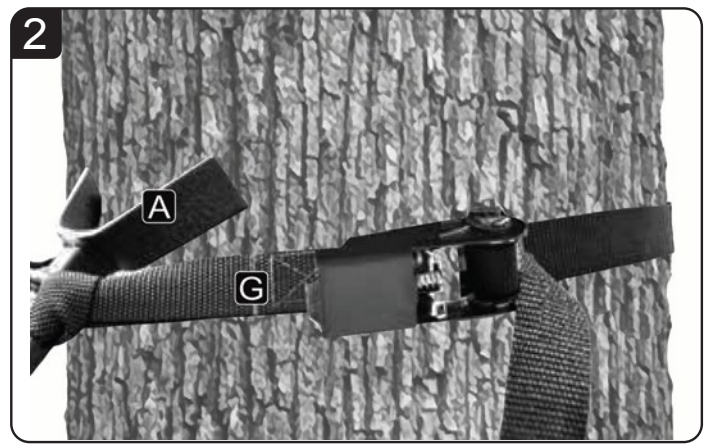



NOTE

This product requires at least two (2) people for safe and correct lifting.

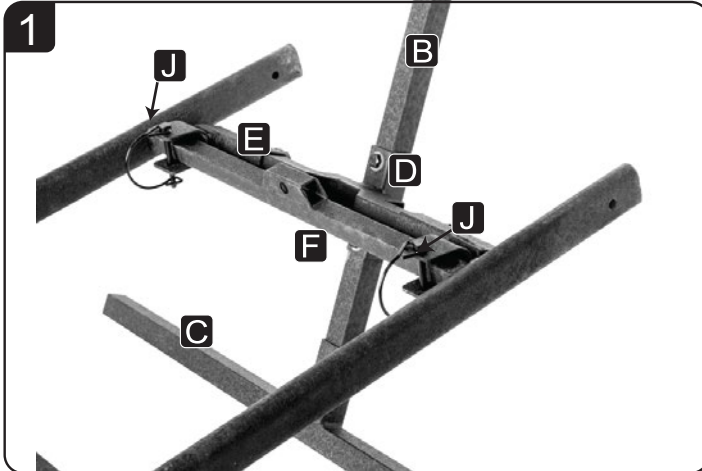

1

Lay out your ladder stand so that the bottom rungs are parallel to the Ladder Stabilizer Aid base. Adjust Right and Left Ladder Attachment Brackets **E / F**, to match the correct width of your ladder stand **NOTE: To increase stability, ALWAYS extend the brackets as wide as possible.** Remove each **M8 Quickclip J** from each Ladder attachment bracket then Lift and place the bottom rungs of your ladder stand into the Right and Left Ladder Attachment Brackets **E / F**. Secure ladder rungs by re-attaching each M8 Quickclips **J** into each Right and Left Ladder Attachment Bracket **E / F** (as shown Left).

2

With one person standing on either side of ladder stand, walk the stand upward, using rungs of the ladder until it is properly and firmly leaning against the tree.

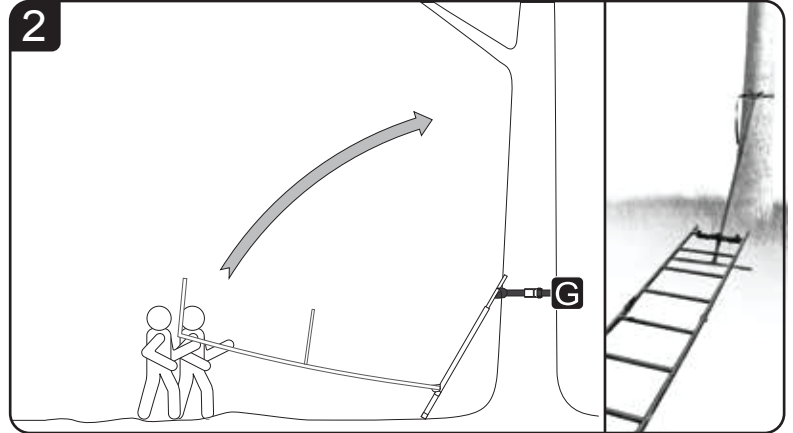

3

Once the ladder stand has made a firm contact with the tree, check sturdiness of connection. Check that it is securely leaning in place with both hands on the ladder rails.

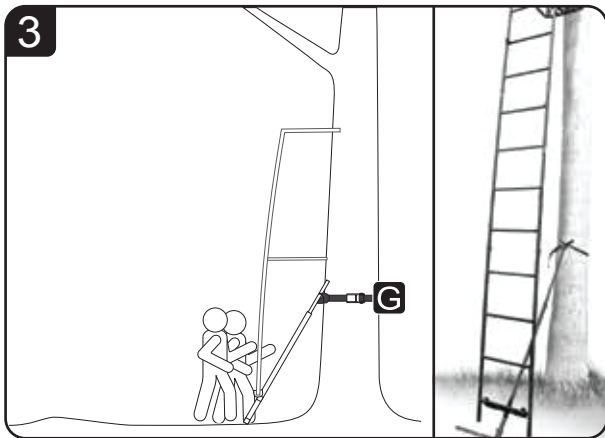

4

BEFORE removing ladder stand from Ladder Aid Stabilizer Base, it is recommended to first secure any **ground-level** ladder securing aids (such as installation straps). Once secured, remove the ladder stand base from the Ladder Aid Stabilizer Base (**Figure A**), then make sure your ladder stand is properly level and angled on the ground. Continue installing your ladder stand according to the manufacturer's instructions. If necessary, you may shorten the Ladder Aid Stabilizer to allow correct positioning for your ladder stand. **NOTE: Follow these instructions in reverse to remove your ladder stand from tree.**

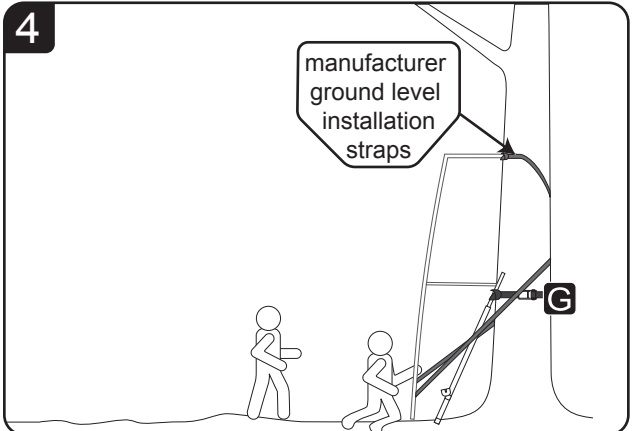

WARNING

NEVER climb or use your ladder stand while it is still connected to the Ladder Aid Stabilizer. **ALWAYS** follow the correct manufacturer's ground-level safety securing instructions of for your ladder stand.

FIG. A

