

PowerHawk 6320 High Density Meter

Installation Guide



Triacta Power Technologies, and the Triacta logo are trademarks of Triacta Power Technologies Inc.

All other trademarks that may be used in this document are the property of their respective holders.

Copyright © Triacta Power Technologies Inc., 2004 to 2013

All rights reserved.

Triacta assumes no responsibility for the accuracy of the information presented, which is subject to change without notice.

Disclaimers

This document contains confidential information which is proprietary to Triacta Power Technologies Inc. Copying and/or distribution of this material is prohibited without the prior approval of authorized Triacta personnel.

Triacta products are intended for commercial uses. The customer hereby agrees that the use, sale, licence or other distribution of the products for any such application without the prior written consent of Triacta, shall be at the customer's sole risk. The customer hereby agrees to defend and hold Triacta harmless from any claims for loss, cost, damage, expense or liability that may arise out of or in connection with the use, sale, licence or other distribution of the products in such applications.

The warranties provided for Triacta products, if any, are set forth in contractual documentation entered into by Triacta and its customers.

This document was originally written in English. If there is any conflict or inconsistency between the English version and any other version of a document, the English version shall prevail.

Table of Contents

PowerHawk 6320 Meter Installation Guide

System description	1
PowerHawk 6320 system specifications	1
Front panel display	1

Installation

Pre-installation	4
Pre-installation check list	4
Site planning	5
Access to power and lighting	5
Installation procedures	6
Mounting the PowerHawk	6
Installing voltage transformers for three-phase service greater than 120V	6
Installing the reference voltage cable and power cable in a 120/240V application	8
Using the auxiliary power input	11
Installing the current transformers	12
Using 5A CT converters with the PowerHawk 6320 meter	15
Connecting the phone line	16
Connecting the Ethernet cable	16
Connecting pulse inputs	16
Start-up sequence for the PowerHawk 6320 meter	17
The initial report	17
Display navigation	18
Normal mode	18
Diagnostics mode	18
Recording the meter map	20

Regulatory Compliance

CSA	22
Federal Communications Commission (FCC) statement	22
Industry Canada Class A emission compliance statement	22
Avis de conformité aux normes d'Industrie Canada	23
Safety requirements and certification	23
Access to equipment	23
Servicing the equipment	23
Equipment servicing	23
Electrical safety compliance	23

NOT FOR DISTRIBUTION WITHOUT THE CONSENT OF TRIACTA POWER

PowerHawk 6320 Meter Installation Guide

This document provides general information about the PowerHawk 6320 high-density meter, and procedures to install and start up the unit, and complete the initial configuration.

- “System description” on page 1
- “Pre-installation” on page 4
- “Installation procedures” on page 6
- “Start-up sequence for the PowerHawk 6320 meter” on page 17
- “Regulatory Compliance” on page 22

This documentation is intended for those responsible for installing and configuring PowerHawk meters.

Installers must be licensed electricians with knowledge of local and national safety regulations.

System description

The PowerHawk 6320 high-density meter is single-phase, poly-phase, and three-phase devices with 20 individual meters. All PowerHawk units are designed for residential, commercial and industrial use with a wye service. They display the power and consumption readings for each measurement point.

PowerHawk 6320 system specifications

The PowerHawk system architecture includes:

- single-phase, poly-phase (network) and three-phase compatibility
- 120/240V and 120/208V configurations
- 20 individual meter points
- local Ethernet configuration interface via PC and web browser
- onboard modem and Ethernet ports for remote reporting

Front panel display

As shown in Figure 1, the PowerHawk 6320 has the following front panel features:

- **LCD** - displays 2 rows of 16 characters for each of the 20 meters
- **Display button** - cycles through the available information for each of the 20 meters
- **Left and right arrow buttons** - selects which of the 20 meters is on the display

Figure 1: PowerHawk front panel

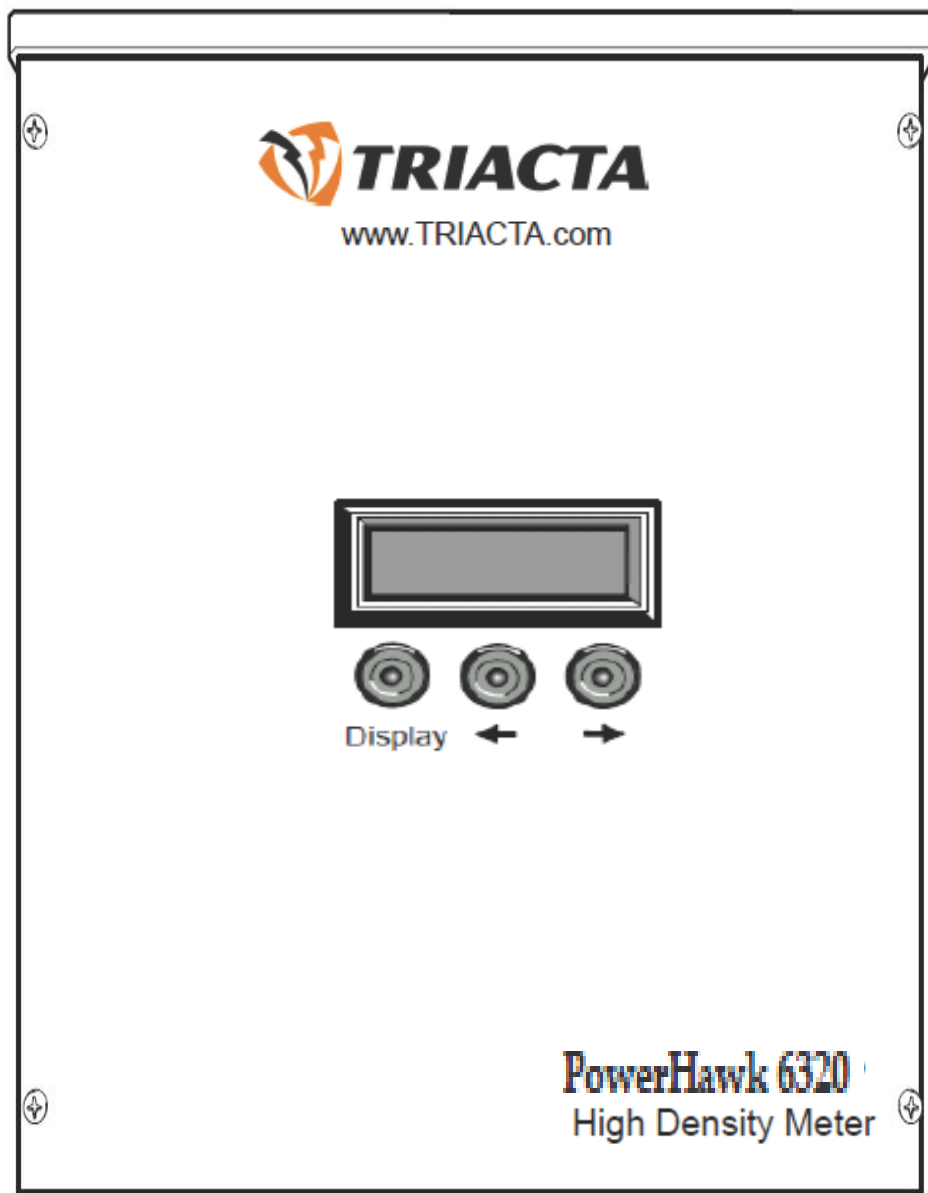

NOT FOR DISTRIBUTION WITHOUT THE CONSENT OF TRIACTA POWER

Table 1 lists the system specifications of the PowerHawk 6320 high-density meter.

Table 1: PowerHawk 6320 specifications

Specification	Description
Dimensions	Height: 16 in. (40.6 cm) Width: 10 in. (20.3 cm) Depth: 2 in. (5.1 cm)
Weight	5.5 lb (2.5 kg)
Reference input voltage	120/208V, 3W+N+PE 120/208V, 2W+N+PE 120/240V, 2W+N+PE
Voltage tolerance	108V to 127V
Maximum current	125 mA, 60 Hz
Current probes	200 A, 400 A, 800 A
Measurement accuracy	Measurement Canada Approved
Pulse input	Dry form A and solid-state form A compatible Internal 3.3V pull-up Maximum frequency 10 Hz Minimum pulse width 20 ms
NVM storage	120 days in 15-minute intervals
Onboard modem	V.90
Onboard Ethernet port	10 Mb/s
Fuse rating	F1, F2, F3: T80 mA or T100 mA, 250V F4: T80 mA or T125 mA, 250V
Operating temperature	32°F to 122°F (0 to 50°C)
Operating humidity	0 to 90% non-condensing
Usage environment	For indoor use only
Maximum altitude	6562 ft. (2000 m)
Pollution degree	2
Installation Category	II
Measurement Category	III

Installation

This section provides pre-installation, installation and system start-up procedures as follows:

- “Pre-installation” on page 4
- “Installation procedures” on page 6
- “Start-up sequence for the PowerHawk 6320 meter” on page 17

Pre-installation

This section provides information about activities that must be performed before installing the equipment at the site. The following topics are covered:

- “Pre-installation check list” on page 4
- “Site planning” on page 5

Pre-installation check list

The following Triacta Power equipment is required for each installation:

- PowerHawk 6320 high-density meters
- two 25-pair CT cables per PowerHawk meter with amphenol connectors, available in lengths of 13 ft. (4 m) or 26 ft. (8 m)
- serialized current transformers for metering

Note: The current transformers supplied by Triacta are certified, and comply with national electrical codes.

When you receive your order, verify that the items listed above are included with the shipment, and visually inspect them for damage. If any parts are missing or damaged, contact your Triacta representative.

The installer must provide the following tools and equipment before proceeding with the installation:

- an appropriate breaker for the type of panel: single-, poly-, or three-phase depending on the installation, or a fused disconnect switch
- current/voltage meter to test the phasing of panels
- phone or butt set to test the phone line
- RJ11 junction box
- RJ11 splitter to tap into the existing junction box
- RJ11 patch cable
- xDSL filter if required (many businesses have their internet access on the same line as the fax)
- RJ45 Ethernet patch cable
- 4-wire 14 AWG (1.63 mm²) cable for three-phase PowerHawk installation
- 3-wire 14 AWG (1.63 mm²) cable for single-phase or poly-phase PowerHawk installation
- small flat-head screwdriver
- crimping tool
- 22 AWG to 18 AWG crimps
- wire strippers
- four 1-inch (25-mm) #8 mounting screws suitable for the selected mounting surface

Site planning

1. Determine the number of PowerHawk units to be installed and ensure there is adequate space.
2. Determine the number of analog phone lines or ethernet drops required, and ensure they are installed before installing the PowerHawk unit.
3. Determine the number and types of meters or monitors required (single-phase, poly-phase, or three-phase).

Access to power and lighting

The installation site must be supplied with access to the main electrical panel and any sub-panels. Portable or permanent lighting must be available to provide the installers with a clear view of the equipment and of the installation environment. Each installation may vary depending on physical site restrictions.

Installation procedures

This section provides information about activities that must be performed to install the PowerHawk in a single-phase, poly-phase, or three-phase application (120/208V or 120/240V). The installation procedures must be performed in the order listed in Table 2 to ensure safety and proper functioning of the equipment.



WARNING: If the equipment is installed or used in a manner not specified in this document, the protection of the equipment may be impaired.

Table 2: Installation procedures

Installation type	Installation procedure and page reference
208V/240V installation	“Installing the reference voltage cable and power cable in a 120/240V application” on page 8 “Using the auxiliary power input” on page 11 “Installing the current transformers” on page 12 “Using 5A CT converters with the PowerHawk 6320 meter” on page 15 “Connecting the phone line” on page 16 “Connecting pulse inputs” on page 16 “Connecting the Ethernet cable” on page 16 “Start-up sequence for the PowerHawk 6320 meter” on page 17 “The initial report” on page 17 “Recording the meter map” on page 20

Mounting the PowerHawk

The PowerHawk is mounted adjacent to the main breaker box. The unit can be mounted either horizontally or vertically, depending on the preferred routing of the wiring. It should be securely mounted with four 1-inch (25 mm) #8 mounting screws suitable for the selected mounting surface. If mounting the unit on a gyprock surface, also use cylinder plugs.

1. Remove the front cover from the PowerHawk by removing the four screws with a Phillips screwdriver. Keep the cover and screws in a safe place for re-installing.
2. Mount the PowerHawk on the wall and secure it by inserting a screw in each mounting keyhole and tightening the screws.

Installing voltage transformers for three-phase service greater than 120V

Voltage transformers are required when monitoring services greater than 120V. Measurement Canada approved VTs to reduce the line-to-neutral voltage of the service to 120V. The accuracy class should be 0.3% or better, with a burden rating of 150VA.

Voltage transformers must be mounted in a listed electrical enclosure. Mount the voltage transformer enclosure between the supply voltage and the PowerHawk. Transformer configuration must be Y||Y. Figure 2 shows a block diagram of a complete three-phase 4-wire installation.

Figure 2: Typical three-phase 4-wire installation

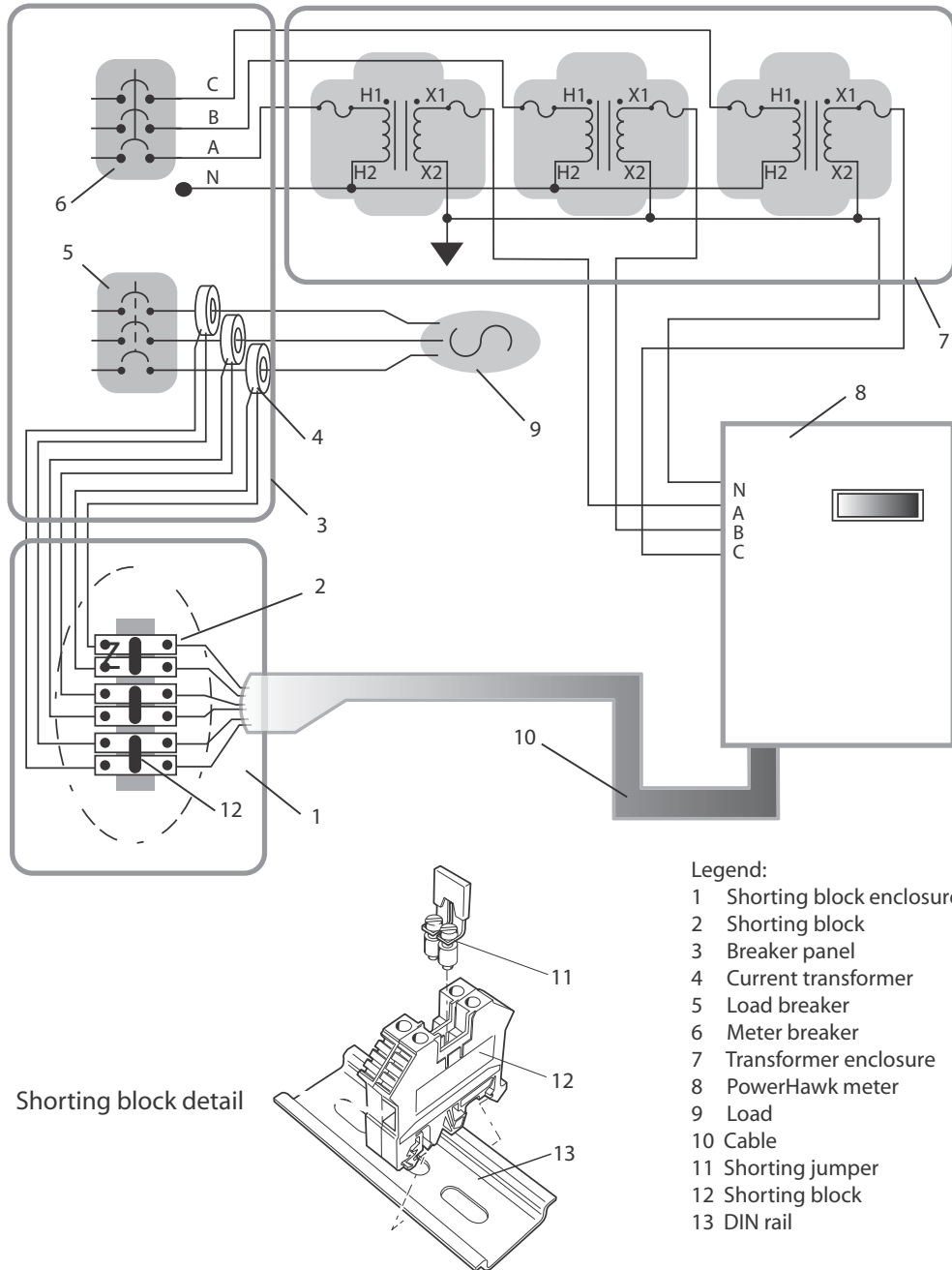

NOT FOR DISTRIBUTION WITHOUT THE CONSENT OF TRIACTA POWER

Installing the reference voltage cable and power cable in a 120/240V application

The PowerHawk has two voltage inputs. Auxiliary voltage is phase-independent and only provides power to the internal circuits. The reference voltage (A, B, C, N) provides phase voltages for power calculations, and the configuration depends on the type of service being metered (single-phase, poly-phase, or three-phase).

The PowerHawk 6320 is shipped from the factory with shorting wires in the auxiliary power inputs that power the unit from the reference voltage inputs. The following procedures explain how to connect the reference voltage inputs for each of the service types. For instructions on how to use the auxiliary power inputs see “Using the auxiliary power input” on page 11.

For a single- or poly-phase panel, use a 3-wire (red, black, white) 14 AWG (1.63 mm²) cable. For a three-phase panel, use a 4-wire (red, black, blue, white) 14 AWG (1.63 mm²) cable. Metallic, flexible armored cable (BX cable) is recommended for commercial installations.

As a safety precaution, the PowerHawk must be connected to its own breaker or switched disconnect so it can be powered down separately by tripping a single breaker. The disconnect device must be located within easy reach of the meter operator, and must be labeled. For multiple PowerHawk installations, the same disconnect can be used to power all PowerHawk units.

To install the power cable in a 120/240V application



WARNING: Ensure that the breaker you use to provide power to the PowerHawk is off before connecting the power cable.



CAUTION: When connecting the power, ensure that there is a 1-inch loop of wire on each lead inside the unit.



Note: If the breaker panel does not designate phase A and phase B feeds, make your own designation and use it for the rest of the installation.

1. Connect the PowerHawk A, B, and N leads to the breaker or fused disconnect as follows:



WARNING: The A, B, wiring sequence between the PowerHawk and the panel must match, or the measurement readings will be wrong.

- a. For a single-phase panel (see Figure 3), connect:
- PowerHawk A terminal to breaker phase A (red wire)
 - PowerHawk B terminal to breaker phase B (black wire)
 - PowerHawk neutral terminal to neutral bar in panel (white wire)
 - Earth wire to earth post using lug provided
 - Phase C is not connected

Figure 3: PowerHawk 120/240V single-phase connection

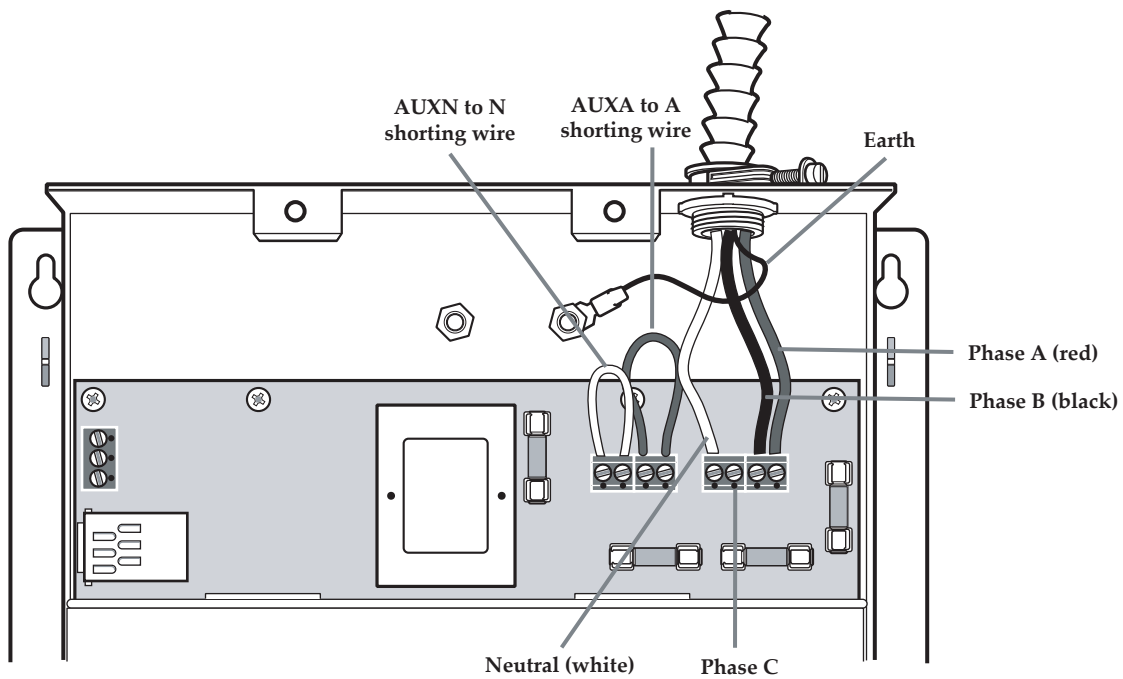

- b. For a three-phase wye panel (see Figure 4), connect:
- PowerHawk A terminal to breaker phase A (red wire)
 - PowerHawk B terminal to breaker phase B (black wire)
 - PowerHawk C terminal to breaker phase C (blue wire)
 - PowerHawk neutral terminal to neutral bar in panel (white wire)
 - Earth wire to earth post using lug provided

Figure 4: PowerHawk 120/208V three-phase wye service connection

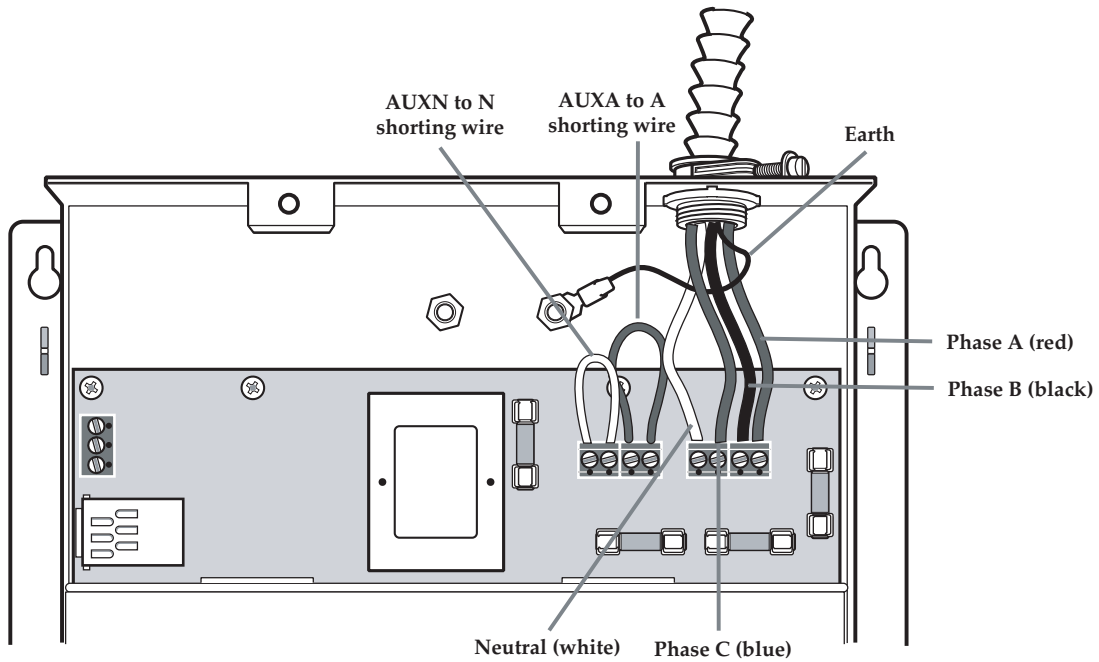

2. Replace the front cover of the PowerHawk and secure it in place with the four screws.
3. If more than one meter is being installed, repeat this procedure for each additional meter.

Using the auxiliary power input

The PowerHawk comes equipped with an auxiliary power input that can be used to power the system independently from the reference voltage inputs described in the previous section.

Because the default configuration for powering the unit is through the reference voltage inputs, the system is configured at the factory with shorting wires on the auxiliary power input. If you choose to power the unit through the auxiliary power input, the shorting bars must be removed from the auxiliary power connector before connecting the reference voltage inputs.

The auxiliary power inputs are 120V and require a separate breaker or fused disconnect switch.

Figure 5 shows the auxiliary power connections.

To connect the auxiliary power input

1. Remove the second punch-out at the top of the unit.
2. Remove the shorting wires connecting AUXA to A, and AUXN to N on the auxiliary power input connector.
3. Connect PowerHawk AUXA and AUXN to a 120V source.
4. Connect the earth wire to the earth post using the lug provided.

Figure 5: Connecting auxiliary power input

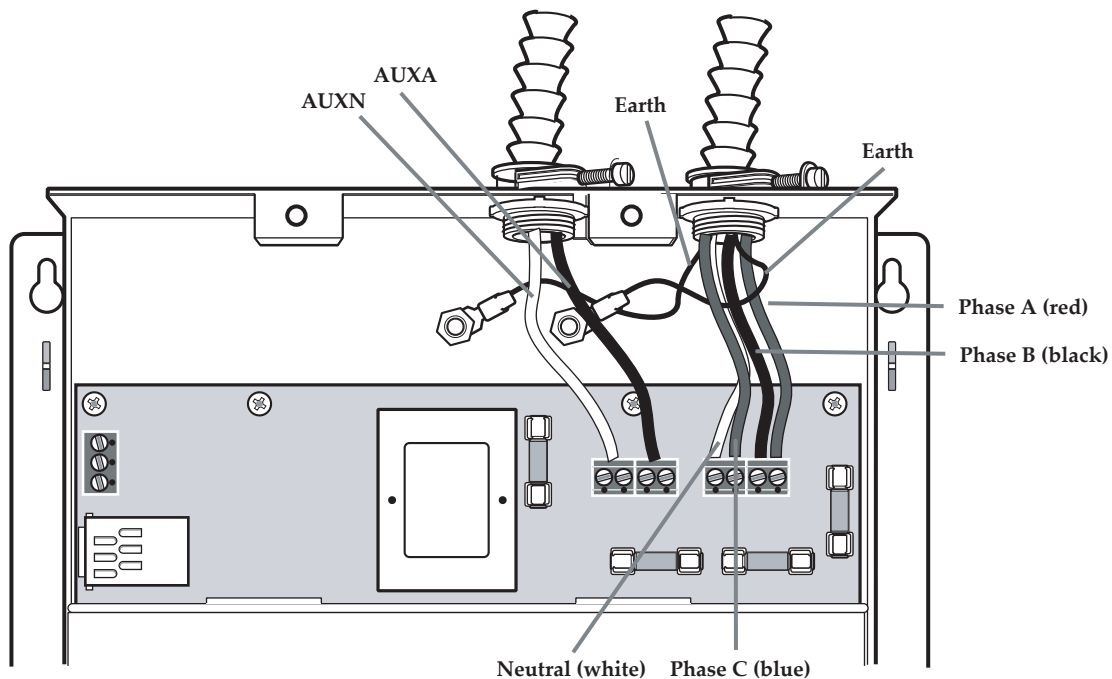

Installing the current transformers

The mA solid-core current transformers (CTs) are connected directly to the CT cables. When using a 5A CT adaptor, the adaptor is connected to the CT cable and the 5A CT is connected to the adaptor.

All solid-core and CT adaptors are labeled for use with a specific meter, and must be used with the correct meter port to ensure meter accuracy.

As shown in Figure 6, CTs are N Amp solid-core CTs that are installed on existing connections. Current transformers connect to the PowerHawk through the two 25-pair CT cables labeled Cable 1 and Cable 2. See Table 3 for the definition of the CT probe pairs within the cable colour scheme.



Note: All CTs should have external shorting blocks to limit open circuit voltages to safe levels.

Installation of mA CTs

Each CT has a black and white wire pair and uses butt connectors to attach the CT to a specific PowerHawk probe pair. The direction of the energy flow is indicated on the CT, as shown in Figure 6.

Figure 6: 200A: 80mA current transformer

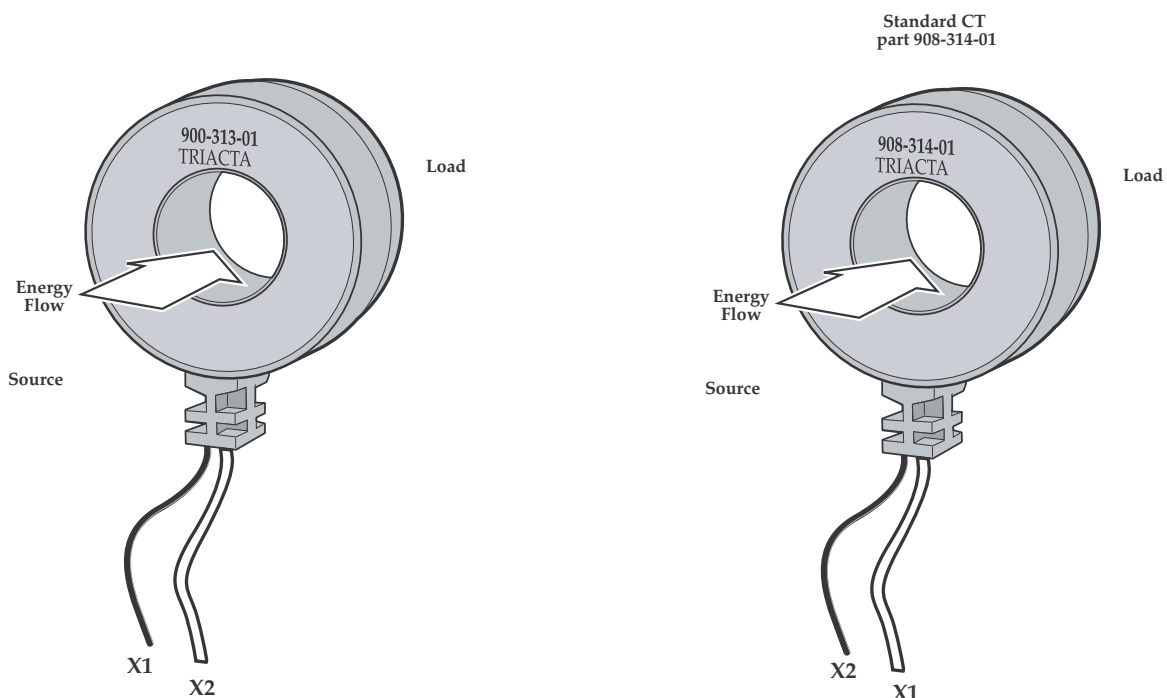



Note: The standard 200A:80mA current transformer shipped with the PowerHawk 6320 is part number 908-314-01 (shown on the right in Figure 6). When retrofitting an installation or redeploying previously shipped current transformers, verify the part numbers and connect the correct X1 and X2 leads to the CT cable as instructed in “To install the current transformers” on page 13.

To install the current transformers



WARNING: Power must not be applied until all CTs are connected to the appropriate circuits, the CTs have been connected to the cables, and both cables have been connected to the PowerHawk. Failure to do so may result in dangerous voltages on the CT lead that may cause severe injury and equipment damage.

1. Connect the 25-pin amphenol connector of cable 2 to the PowerHawk connector located at the bottom of the unit, and secure it in place with the retaining clips. Repeat for cable 1.
2. Feed the free end of Cable 1 and Cable 2 through a 3/4-inch punch-out on the hydro panel with strain relief.
3. Strip the plastic sheaths back to an appropriate length to expose the wire pairs. Cut and strip the CT leads and wire pair leads to an appropriate length.
4. Crimp the CT probe leads to the CTs for each PowerHawk as follows: black CT wire to first half of the CT probe pair, white CT wire to the second half of the CT probe pair. See Table 3 for the list of probe colour pairs for the PowerHawk 6320 high-density meters.
5. Switch the breaker off for the circuit being installed and remove the feed wire. Place the CT over the wire and reconnect to the breaker.
6. Repeat steps 3 to 5 for the remaining CTs.



Note: The direction of the energy flow is indicated on the CT.

Table 3: Colour pair identification for PowerHawk 6320 high-density meters

Cable 1 Pairs	Connect Black CT lead to:	Connect White CT lead to:	Cable 2 Pairs	Connect Black CT lead to:	Connect White CT lead to:
P1-1	Black	Green	P11-1	Black	Green
P1-2	Black	White	P11-2	Black	White
P1-3	Black	Red	P11-3	Black	Red
P2-1	Red	Green	P12-1	Black	Brown
P2-2	Red	White	P12-2	Black	Yellow
P2-3	Black	Orange	P12-3	Black	Blue
P3-1	Black	Brown	P13-1	Green	White
P3-2	Black	Yellow	P13-2	Red	Orange
P3-3	Black	Blue	P13-3	Red	Brown
P4-1	Green	Yellow	P14-1	Red	Yellow
P4-2	Green	Blue	P14-2	Red	Blue
P4-3	Green	White	P14-3	Red	Green
P5-1	White	Blue	P15-1	White	Brown
P5-2	Green	Orange	P15-2	White	Yellow
P5-3	Green	Brown	P15-3	White	Blue
P6-1	Blue	Yellow	P16-1	Red	White
P6-3	White	Orange	P16-3	Black	Orange
P7-1	Red	Orange	P17-1	Green	Yellow
P7-3	Red	Brown	P17-3	Green	Blue
P8-1	Blue	Orange	P18-1	Blue	Yellow
P8-3	Blue	Brown	P18-3	White	Orange
P9-1	White	Brown	P19-1	Blue	Orange
P9-3	White	Yellow	P19-3	Blue	Brown
P10-1	Red	Yellow	P20-1	Green	Orange
P10-3	Red	Blue	P20-3	Green	Brown

Using 5A CT converters with the PowerHawk 6320 meter

When both low-current (200A and 400A) and high-current (600A or higher) circuits need to be measured with the same PowerHawk meter, converters are available to allow the use of Measurement Canada approved 5A CTs with the appropriate current rating. 5A CT converters transform the 5A maximum output from a standard CT to the 80mA maximum of the PowerHawk meter.

The 5A side of the converter is the black and red wire pair, and the 80mA side of the converter is the black and white wire pair.

It is recommended that 5A converters and shorting devices be installed in a sealable metal enclosure.

To connect the 5A CT to the converter on the PowerHawk 6320, follow these steps:

1. Connect the X1 lead of the 5A CT to the shorting device.
2. Connect the X2 lead of the 5A CT to the shorting device.
3. Connect the X1 lead (red) from the 5A side of the converter to the CT X1 lead on the shorting device.
4. Connect the X2 lead (black) from the 5A side of the converter to the CT X2 lead on the shorting device.
5. Connect the X1 lead (white) from the 80mA side of the converter to the X1 lead within the 25 pair cable for the selected meter point listed in Table 3.
6. Connect the X2 lead (black) from the 80mA side of the converter to the X2 lead within the 25 pair cable for the selected meter point listed in Table 3.

Figure 7 shows a 5A CT connected to the converter.

Figure 7: PowerHawk 6320 meter 5A CT connection to converter

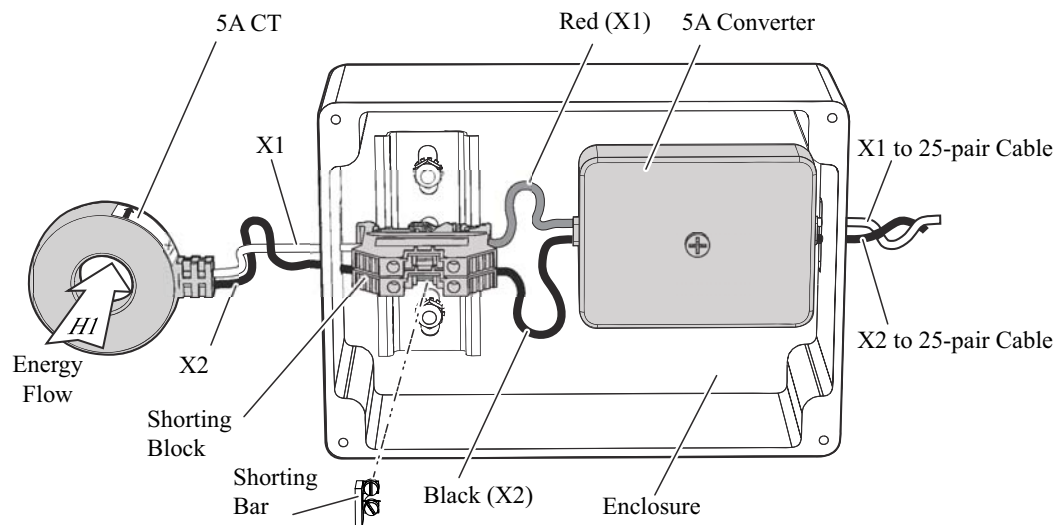

Connecting the phone line

If the modem reporting option is being used, an analogue telephone patch cable is required to connect the customer phone line to the PowerHawk.

1. Connect the patch cable between the termination block of the phone line and the PowerHawk.
2. Disconnect the Ethernet cable (if an Ethernet cable is connected, reporting defaults to the Ethernet port).

A single phone line can be daisy-chained to several PowerHawk meters.

Connecting the Ethernet cable

If the IP reporting option is being used, a separate RJ45 patch cable is required to connect the Ethernet port for each PowerHawk meter to the local Ethernet network.

If the local network automatically assigns IP addresses through a DHCP server, the PowerHawk meter will be able to report using its factory default IP settings. If there is no DHCP server, refer to the PowerHawk meter Configuration Guide for instructions to configure default static IP addresses.

Connecting pulse inputs

The pulse input on the PowerHawk 6320 can be used to count and report pulses generated by another meter (pulsing device).

Connect the output of the pulsing device to PIN 2 and PIN 3 of the “pulse in” terminal blocks in the PowerHawk 6320 meter, as shown in Figure 8. The pulse inputs are compatible with both dry and solid-state form A contacts, 10 Hz maximum frequency, 20 ms minimum pulse width.

When the pulsing device provides dry relay contacts the pulse input is not polarity-sensitive. When the pulsing device provides solid-state form A outputs, the GND (negative) terminal from the source device must be connected to PIN 3 of the pulse in terminal block.

The pulsing device can be located up to 1,000 feet away from the PowerHawk meter with 22 AWG twisted pair wire.

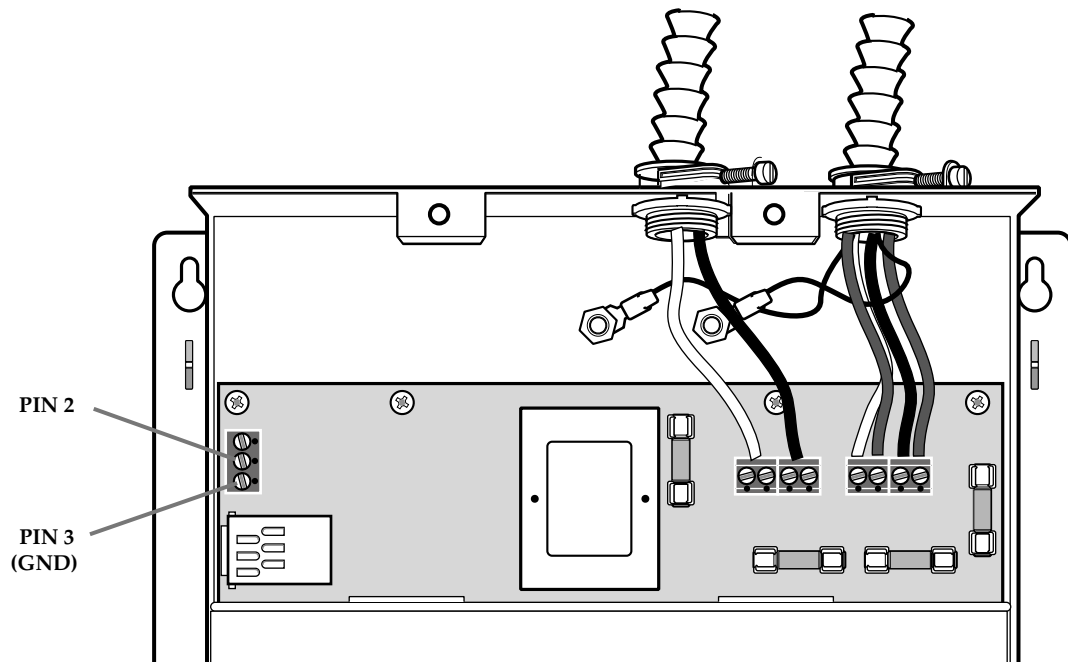
Figure 8: PowerHawk 6320 Pulse Input Connection

Start-up sequence for the PowerHawk 6320 meter

Once the CTs are connected, and the breaker is closed, the PowerHawk automatically starts up. The LCD on the front panel of the PowerHawk indicates the operating status of the unit as follows:

- Initial power up message “PowerHawk 6320”
- Once the internal configuration is complete, the display will show default information for the first meter

The initial report

To manually force the PowerHawk to report to the Triacta Data Centre, perform the following:

1. Press and hold the Display button for 5 to 7 seconds until diagnostics mode is displayed, then release.
2. Press the Display button until the “Send” command appears on the display.
3. Press the right arrow button to manually force the PowerHawk to report meter data. This will clear any old data from the PowerHawk memory and ensure that the time is set correctly.

Display navigation

The PowerHawk has three buttons to control the information presented on the LCD. The display has a normal and a diagnostics mode. The PowerHawk starts in normal mode, and will enter diagnostics mode when the Display button is pressed and held for 5 seconds. To adjust the contrast, hold down the Display button, and use the right and left arrow buttons to increase and decrease the contrast respectively.

Normal mode

In Normal mode, the Display button scrolls one or more of the following information:

- energy consumption in kWh for the selected meter
- power in Watts for the selected meter

In Normal mode, the right and left arrow buttons scroll the display from meter points 1 through N.

Diagnostics mode

Diagnostics mode is accessed by pressing and holding the Display button for 5 seconds. In Diagnostics mode, press the Display button to scroll through the following information:

- energy consumption in kWh for the selected meter
- power in Watts for the selected meter
- send data command
- configuration information showing phase setting, CT rating in Amps, and power in Watts for the selected probe
- configuration information showing phase setting and voltage for the selected probe
- local IP address
- set default IP
- date and time (UTC)

In Diagnostics mode, the right and left arrow buttons scroll the display from meter 1 through N. When the local IP address is shown on the LCD, use the right and left arrow buttons to scroll through the following information:

- remote host IP address
- default IP address
- default NetMask
- default gateway
- PPP user name
- phone number
- AT command string
- alternate phone number
- unit serial number
- firmware build number
- Ethernet port MAC address
- firmware revision
- power transformer ratio

Recording the meter map

The final step in the installation process is to record the mapping of the meters to the probe points. Table 4 shows an example of a completed circuit map. Table 5 is to be completed and returned for input to the Triacta database. A copy of Table 5 is provided with each PowerHawk 6320.

Installation Record

Distributor:	
Customer:	
Address:	
Postal code:	
Phone number:	
Installation date:	
Installer name:	
PowerHawk 6320 serial number:	Located on the bottom of the unit
PowerHawk 6320 MAC:	Located on the right-hand flange of the unit

Table 4: Example of a completed Probe to Circuit Map

Probe	Phase	CT	Brkr	Description	Description	Brkr	CT	Phase	Probe
1	A	250	1	RTU 1	Fan	2	100	A	26
2	B	250	3	RTU 1	Lights	4	100	B	27
3	C	250	5	RTU 1	Heater A	6	150	C	28
			7		Heater A	8	150	A	29
			9			10			
			11			12			
			13			14			
			15			16			
			17			18			
			19			20			
			21			22			
			23			24			

Installation Record

Distributor:
Customer:
Address:
Postal code:
Phone number:
Installation date:
Installer name:
PowerHawk serial number:
PowerHawk MAC:

Table 5: Probe to circuit map

Probe	Phase	CT	Brkr	Description	Description	Brkr	CT	Phase	Probe
			1			2			
			3			4			
			5			6			
			7			8			
			9			10			
			11			12			
			13			14			
			15			16			
			17			18			
			19			20			
			21			22			
			23			24			
			25			26			
			27			28			
			29			30			
			31			32			
			33			34			
			35			36			
			37			38			
			39			40			
			41			42			
			43			44			
			45			46			
			47			48			
			49			50			

NOT FOR DISTRIBUTION WITHOUT THE CONSENT OF TRIACTA POWER

Regulatory Compliance

The PowerHawk must be installed by a certified electrician with knowledge of local safety regulations. Initial installation of the unit, and any subsequent modification to the unit, must be inspected by the local electrical safety authority.

The PowerHawk complies with the standards listed in Table 6.

Table 6: Regulatory Compliance

Discipline	Applicable country	Regulatory and industry standard
Safety	United States Canada	CSA certified CAN/CSA-C22.2 No.61010-1-04 and UL Std. No. 61010-1 2nd Ed.
Emissions (EMC)	United States Canada	FCC Part 15, Class A ICES-003
Surge power/telephone lines	United States Canada	TIA968-A: 2002 CS03

CSA

CSA International is recognized by the Occupational Safety and Health Administration (OSHA) as a Nationally Recognized Testing Laboratory (NRTL). It is also accredited in Canada by the Standards Council of Canada (SCC). This equipment complies with UL 61010-1 Second Edition and CSA C22.2 No. 61010-1-04.

Federal Communications Commission (FCC) statement



CAUTION: This equipment has been tested and found to comply with the limits for a Class A digital device, pursuant to Part 15 of the FCC Rules. These limits are designed to provide reasonable protection against harmful interference when the equipment is operated in a commercial environment. This equipment generates, uses, and can radiate radio frequency energy and, if not installed and used in accordance with the instruction manual, may cause harmful interference to radio communications. Operation of this equipment in a residential area is likely to cause harmful interference, in which case the user will be required to correct the interference at their own expense.

Industry Canada Class A emission compliance statement

This equipment does not exceed the Class A limits for radio noise emissions from digital apparatus as set out in the radio interference regulations of the Canadian ICES-003.

Avis de conformité aux normes d'Industrie Canada

Cet appareil numérique de la classe A est conforme à la norme NMB-003 du Canada.

Safety requirements and certification

The information in this section must be considered as a mandatory requirement, and must be strictly adhered to when installing and operating a PowerHawk 6320 unit.

Access to equipment

The equipment must be accessible to authorized personnel only. Equipment must be installed in areas where access can be restricted.

Servicing the equipment

No preventive maintenance is required on any of the equipment. Visually inspect the equipment yearly and ensure it is free of dust or other particles. If necessary, wipe with a clean cloth.

Equipment servicing

Individual components are not user-serviceable, and must be returned to Triacta for repair. If an equipment fault occurs, do not attempt to repair the faulty component.





CAUTION: All maintenance activities should be performed by qualified personnel only. Do not perform any operating or maintenance procedures that are not described in the product documentation provided by Triacta Power Technologies.

Electrical safety compliance

- Use the unit only in accordance with the electrical power rating
- The unit is only to be installed by a certified electrician
- Initial installation of the unit must be inspected by the local electrical safety authority
- Install the unit in compliance with the following local and national electrical codes:
 - Canada: Canadian Electrical Code, Part I, CSA C22.1
 - United States: National Fire Protection Association (NFPA) 70; US National Electrical Code
 - Elsewhere: International Electrotechnical Commission (IEC) 364, Part 1-7
- Ensure that the unit is properly earthed
- If the equipment is installed or used in a manner other than that specified in this document, it may void your warranty or impair the protection of the equipment.

Table 7: Graphical symbols that appear on equipment

Symbol	Description
	<p>Indicates the supply wire protective earth, also known as chassis ground, for the secondary or feedthrough ground.</p>
	<p>Indicates the supply wire protective earth, also known as chassis ground, for the primary ground.</p>
	<p>The warning symbol indicates that the activity or situation may cause equipment damage or pose a threat to personal safety.</p>

NOT FOR DISTRIBUTION WITHOUT THE CONSENT OF TRIACTA POWER

Index

- 120 V/240 V
 - install reference voltage cable and power cable, 8
- 5A CT converters
 - installing, 14

A

- audience, 1

C

- certification
 - safety, 23
- compliance
 - electrical safety, 23
 - regulatory, 22
- Connecting, 16
- current probes
 - PowerHawk, 3
- current transformers
 - installing, 12

D

- dimensions
 - PowerHawk, 3

E

- electrical safety compliance, 23
- equipment servicing, 23
- Ethernet cable
 - connecting, 16

F

- fuse rating
 - PowerHawk, 3

I

- initial report
 - force, 17
- Installation, 3
- installation, 4
 - current transformers, 12
- installation procedures
 - overview, 6

M

- maximum altitude
 - PowerHawk, 3
- maximum current

- PowerHawk, 3
- Measurement, 3
- measurement accuracy
 - PowerHawk, 3
- measurement category
 - PowerHawk, 3
- meter map
 - recording, 20

N

- NVM storage
 - PowerHawk, 3

O

- onboard Ethernet port
 - PowerHawk, 3
- onboard modem
 - PowerHawk, 3
- operating humidity
 - PowerHawk, 3
- operating temperature
 - PowerHawk, 3

P

- pollution degree
 - PowerHawk, 3
- PowerHawk
 - current probes, 3
 - dimensions, 3
 - fuse rating, 3
 - installation in a single--phase panel, 9
 - installation in a three-phase wye panel, 10
 - maximum altitude, 3
 - maximum current, 3
 - measurement accuracy, 3
 - measurement category, 3
 - mounting, 6
 - NVM storage, 3
 - onboard Ethernet port, 3
 - onboard modem, 3
 - operating humidity, 3
 - operating temperature, 3
 - pollution degree, 3
 - reference input voltage, 3
 - specifications, 3
 - system description, 1
 - usage environment, 3
 - voltage tolerance, 3
 - weight, 3
- pre-installation, 4

Pulse, 3
pulse inputs
 connecting, 16

R

reference input voltage
 PowerHawk, 3
reference voltage cable and power cable installation
 120 V/240 V application, 8
regulatory compliance, 22
requirements, safety, 23

S

safety
 certification, 23
 requirements, 23
servicing equipment, 23
site planning, 5
site preparation

 lighting, 5
 power, 5
specifications
 PowerHawk, 3
system description
 PowerHawk, 1

U

usage environment
 PowerHawk, 3

V

voltage tolerance
 PowerHawk, 3

W

weight
 PowerHawk, 3



Corporate Headquarters

130 Industrial Ave., Unit 100
Carleton Place, Ontario
Canada K7C 3T2
www.triactapower.com

Triacta Power and the Triacta logo
are trademarks of Triacta Power Technologies Inc.
Other trademarks that may be used in this document
are property of their respective owners.

©Triacta Power Technologies Inc., 2004-2013
Printed in Canada

Part number 930-103-01-C.00