



E550

EXCAVATOR OPERATING WEIGHT CLASS 550 TONNES



The Sleipner System can significantly increase the productivity of your mine.

HOW?

By safely increasing travel speeds over 80%. By reducing undercarriage maintenance times at least 50%. And by considerably cutting fuel consumption and CO₂ emissions while travelling.

**How is this possible?
READ ON.**



E550



GET MORE OUT OF YOUR MINES.

The Sleipner System is a groundbreaking innovation that is changing excavator logistics for good. Traditional methods cost time and money while keeping machines out of work for long periods of time.

Sleipner enables moving excavators around safely and phenomenally faster – every spin of a Sleipner wheel saves you money as well as time to be directed into productive work. This clever system is simple in idea, simple to acquire, and simple to use. And we will help you every step of the way.

SLEIPNER BENEFITS:

LESS TIME, FEWER COSTS, MORE PROFITS

While time drags as other miners wait for their excavators to travel or their undercarriages to be serviced, satisfied Sleipner users watch theirs dig.

Without Sleipner, up to 15% of excavator working time is spent travelling. The Sleipner System reduces travel time by 70% and doubles, or even triples, undercarriage lifetime, significantly

reducing maintenance costs and downtime while increasing excavator utilization.

Sleipner is a sustainable solution. It reduces fuel consumption and CO₂ emissions while travelling by over 80%. All this means fewer costs and more profits. Do the math. Sleipner may just be the best investment you have ever made.

SUITABLE COMBINATIONS

All weights in metric tons

Sleipner model	Weight class	Combination examples	
		Excavators	Trucks
E550	550 tonnes	Cat 6050/6060 Komatsu PC5500 Hitachi EX5600	Cat 797 Komatsu 960E

NOTICE: In order to ensure the equipment suitability and performance capabilities every truck and excavator combination must be checked case by case. Site conditions are also required for the preliminary analysis.

TECHNICAL DETAILS

At Slepner we are proud of our high quality products. Our brand not only represents our vision, but also the effort we put into making a product that will last at least twice the operational lifetime of an excavator. Still today, the first Slepner ever built is fully functional.

Our top engineers have carefully designed every single component of the Slepner System, and they are produced with the highest precision.

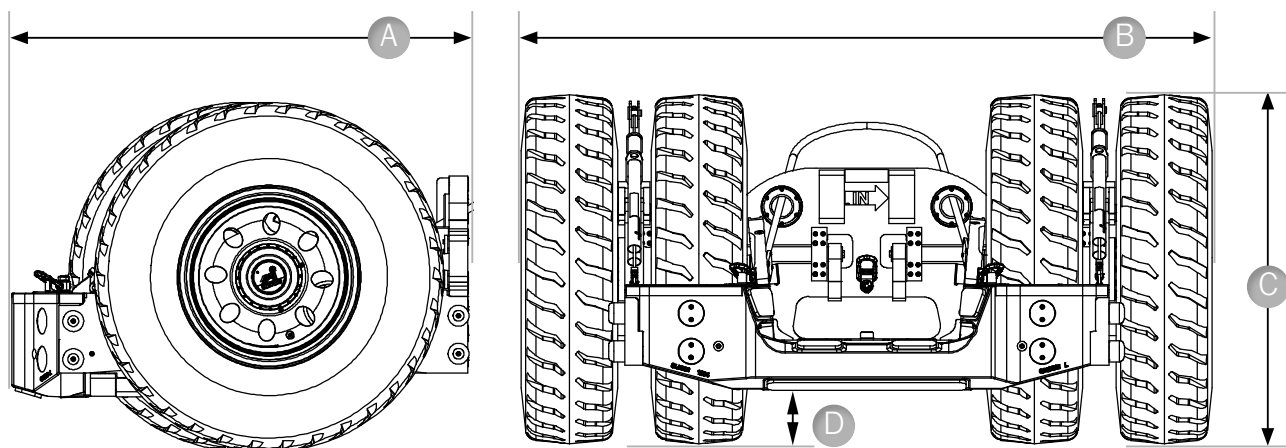

Dimensions

A	3,60 m
B	5,45 m
C	2,70 m
D	0,40 m

Track width	Weight (per pair)
1300-1400 mm	93 tonnes

Max allowed loader weight	565 tonnes
Max allowed driving speed	10 km/h
Operating temperature - Available for arctic conditions on request	-25 °C ... +55 °C -40 °C ... +55 °C
Tyre size	27.00-49
Tyre type and ply	Bias 54
Tyre quantity	8

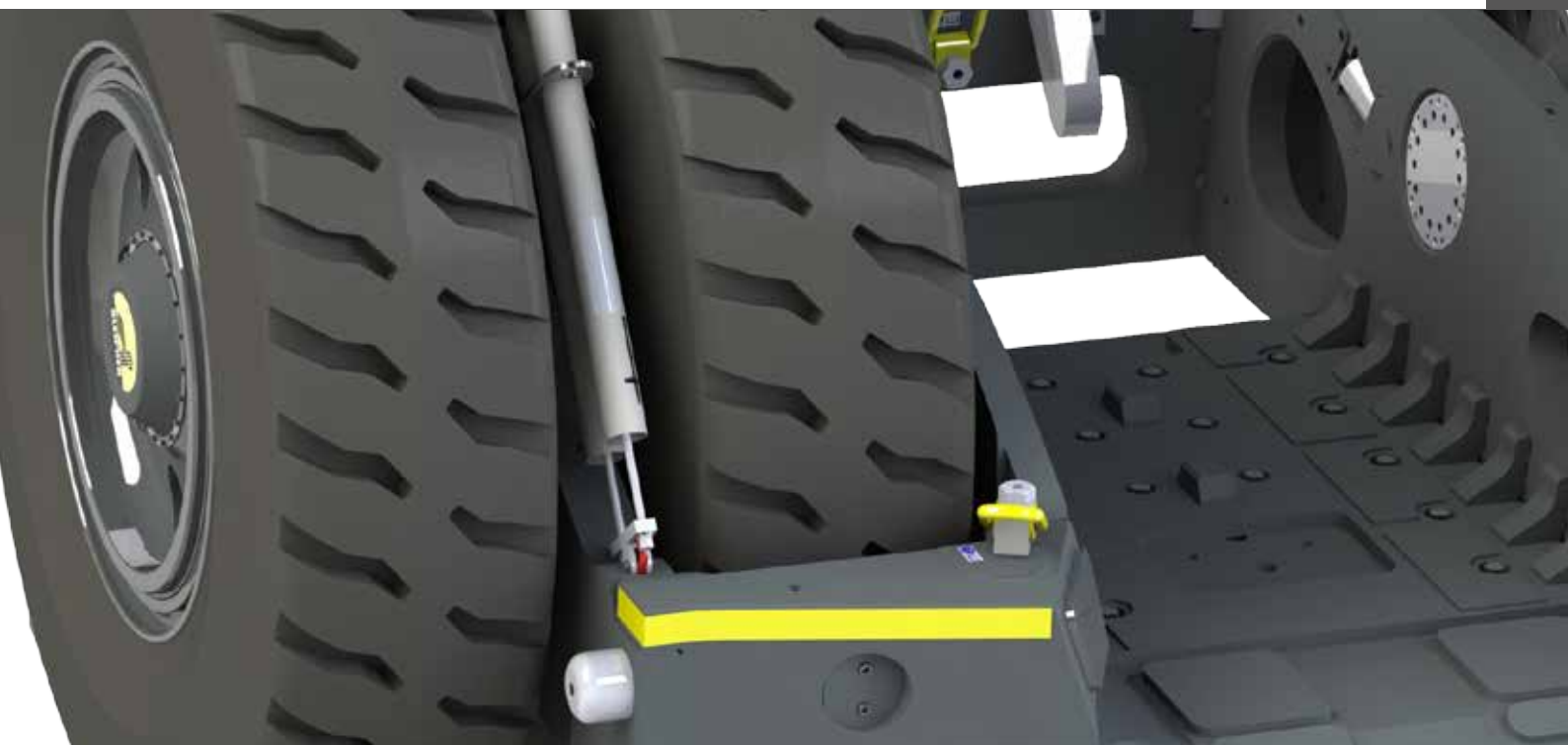

CONVINCED? INTERESTED IN KNOWING MORE?

If you are already convinced of Sleipner's substantial benefits and are ready to order, or if you want to learn more, please go to www.sleipner.fi, email to sleipner@sleipner.fi or contact your nearest dealer.



Simply ride and roll.

Sleipner Finland Oy
sleipner@sleipner.fi
www.sleipner.fi

Sleipner Finland Oy reserves the rights for modifications and updates.