

therM₂[®]



 **Continental
UNDERFLOOR**



Table of contents

Product image	1	Locking / unlocking therM ₂	20
Table of contents	2	Standby / away mode	21
What is a programmable room thermostat?	3-4	Power on / off	22
Installation procedure	5-6	Holiday programming	23
Mode select / factory reset	7-8	Optional features	24-27
WiFi setup	9	Re-calibrating therM ₂	28
Pairing with therM2 app	10	Error codes	28
		Thermostat mode wiring diagram	29-30
Mode 1 - Thermostat	11	Mode 2 - Time clock	31
LCD display	12-13	LCD display	32-33
Temperature display	14	Setting the switching times	34
Setting the time & date	15	Timer boost	35
Setting the comfort levels	16-17	Optional features	36
Setting the temperature	18	Optional features table	36
Temperature hold	19	Time clock mode wiring diagrams	37-38
		Battery replacement	39

? What is a programmable room thermostat?

A programmable room thermostat is both a programmer and a room thermostat.

A programmer allows you to set “on” and “off” periods to suit your own lifestyle.

A room thermostat works by sensing the air temperature, switching on the heating when the air temperature falls below the thermostat setting, and switching it off once this set temperature has been reached.

So a programmable room thermostat lets you choose what times you want the heating to be on, and what temperature it should reach while it is on. It will allow you to select different temperatures in your home at different times of the day (and days of the week) to meet your particular needs and preferences.

Setting a programmable room thermostat to a higher temperature will not make the room heat up any faster. How quickly the room heats up depends on the design and size of the heating system.

Similarly reducing the temperature setting does not affect how quickly the room cools down. Setting a programmable room thermostat to a lower temperature will result in the room being controlled at a lower temperature, and saves energy.

The way to set and use your programmable room thermostat is to find the lowest temperature settings that you are comfortable with at the different times you have chosen, and then leave it alone to do its job.

The best way to do this is to set the room thermostat to a low temperature – say 18°C and then turn it up by 1°C each day until you are comfortable with the temperature. You won't have to adjust the thermostat further. Any adjustment above this setting will waste energy and cost you more money.

You are able to temporarily adjust the heating program by overriding or using the temperature hold feature. These features are explained further on pages 18 and 19 of this manual.

Programmable room thermostats need a free flow of air to sense the temperature, so they must not be covered by curtains or blocked by furniture. Nearby electric fires, televisions, wall or table lamps may also prevent the thermostat from working properly.



Installation procedure

Do



Mount therM₂ at eye level.

Read the instructions fully so you get the best from our product.



Don't

Install near to a direct heat source as this will affect functionality.

Push hard on the LCD screen as this may cause irreparable damage.

therM₂ is designed to be flush mounted and requires a back box of 35mm (minimum depth) to be sunk into the wall prior to installation.

Step 1

Using a small screwdriver, slightly loosen the screw from the bottom face of therM₂. You can then carefully separate the front half from the back plate.

Step 2

Place the front of therM₂ somewhere safe.

Terminate therM₂ as shown in the diagrams on pages 29-30 of this booklet.

Note: For time clock wiring connections, terminate as shown on pages 37-38.

Step 3

Screw the back plate of therM₂ securely into the back box.

Step 4

Clip the front of therM₂ onto the back plate, securing it in place with the retaining screw.

1



2



3



4





Mode select

therM₂ can either be used as a thermostat or a time clock.

Thermostat mode is the default setting.

To change between thermostat & time clock modes, follow these steps.

- Use the left / right keys to scroll to setup <>
- Press and hold the tick key for 5 seconds ✓
- Use the up / down keys to scroll between modes ^ v
- Press the tick key to confirm selection ✓

therM₂ will reset all parameters and restart in the selected mode.

Note: The mode select function will reset all parameters that were entered during the set-up and pairing operations. These processes must be repeated after the restart has completed.

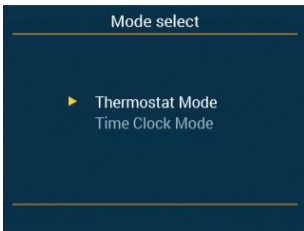

Mode select



Restart screen



Thermostat mode

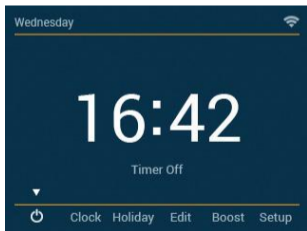

Time clock mode



WiFi setup

To connect therM₂ with the WiFi network follow these steps.

- Use the left / right keys to scroll to setup and press tick < > ✓
- Use the down arrow key to scroll to WiFi setup and press tick ^ v ✓
- Use the up / down keys to scroll to scan available networks ^ v
- Press the tick key ✓
- therM₂ will scan and list all available WiFi networks.
- Use the up / down keys to select a network ^ v
- Press the tick key ✓
- Using the arrow keys to navigate and the tick key to select, enter the network key using the keypad < ✓ > ^ v
- Once the network key has been entered, use the arrow keys and navigate to 'Join' v
- Press the tick key to confirm ✓





therM₂ will then connect to the chosen WiFi network. During this process the WiFi icon and "Connecting" will be displayed. If successful a tick symbol will be displayed next to the network name, therM₂ will then return to the main display.

** Note: To join a closed / hidden WiFi network, within 'WiFi Setup, use the up / down keys to scroll to 'Other'. Here you can manually enter the SSID, security type and security key then select 'Join'.*



Pairing with therM2 app

Download the FREE therM2 App from the Apple App Store, or Google Play Store.

- Open the therM2 app, create your account & login
- Press 'Add location'
- Enter a name for your location, for example 'Home'
- Select the correct time zone for your location, for example 'GMT' then press submit
- Once the location has been created, now add your therM₂ to the location.
- Select 'Add zone' and enter the first zone title, for example 'Living room', press 'Add zone'
- On therM₂, use the left / right keys to scroll to setup and press tick   
- 'Pairing with app' will be highlighted in the menu, press the tick key to start pairing 
- Both the app & therM₂ will display a green tick symbol once pairing is successful

Note: To pair more therM₂ thermostats to the location, select 'Add zone' within the 'Manage zones' section and repeat the steps above.

1

Mode 1 - Thermostat



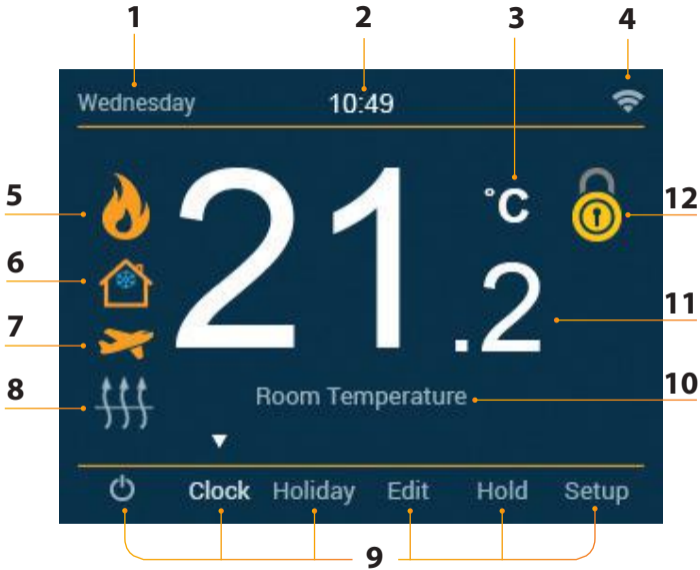

1. Day indicator - Displays the day of the week.
2. Clock - Time displayed in 24 hour format.
3. Temperature format – Degrees celsius or fahrenheit.
4. WiFi indicator - Displayed when connected to a WiFi network.
5. Flame symbol – Displayed when the thermostat is calling for heat and flashes when optimum start is active.
6. Frost protection – Displayed when away / standby modes are active.
7. Holiday – displayed when the thermostat is in holiday mode.
8. Floor limit symbol – Displayed when the floor probe has reached the floor temperature limit configured in the setup menu.
9. Main menu – Highlighted display indicates selected option.
10. Floor / room temp – Indicates the current sensor mode.
11. Temperature – Displays the current sensor temperature.
12. Keypad lock indicator – Displayed when the keypad is locked.

Temperature display

therM₂ can be configured for different sensor options such as built in air sensor, floor sensor or both. The display will clearly indicate which sensor is being used by showing either “Room temperature” or “Floor temperature” under the actual value.



Room temperature



Floor temperature

When therM₂ is set to use both the air & the floor sensor, the room temperature will be displayed by default.

To view the current floor temperature, press and hold the left and right arrow keys for 5 seconds, the floor temperature will then be displayed.





Setting the time and date

Note: When therM₂ is paired with the app, the time & date settings are automatically synchronised according to the location's time zone setting.

To set the clock, follow these steps.

- Use the left / right keys to scroll to clock < >
- Press tick to confirm selection ✓
- Use the left / right keys to scroll between day / month / year values < >
- Use the up / down keys to set the day / month / year values ^ v
- Press tick to confirm selections and progress to time ✓
- Use the left / right keys to scroll between hours and minutes < >
- Use the up / down keys to set the hours / minutes values ^ v
- Press tick to confirm selection and return to the main display ✓



Setting the date

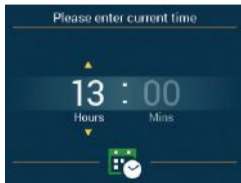

Setting the time



Comfort levels explained

therM₂ offers three program mode options; weekday / weekend programming, 7 day programming and 24 hour programming.

You also have the option to use therM₂ in non-programmable mode.

therM₂ is supplied with comfort levels already programmed, but these can be changed easily. The default times and temperature settings are;

08:00 - 21°C (Wake) 09:30 - 16°C (Leave) 16:30 - 22°C (Return) 23:00 - 17°C (Sleep)

For weekday / weekend programming, the four comfort levels are the same for Mon-Fri, but can be different for Sat-Sun. For 7 day programming each day of the week can have four different comfort levels. In 24 hour mode all days are programmed with the same comfort levels.

- To program the comfort levels, use the left / right keys to scroll to edit <>
- Press tick to confirm selection ✓
- Use the up / down keys to select day / period of week ^ v
- Press tick to confirm selection ✓
- Wake will now be highlighted and the current time and temperature settings shown.
- Press tick to alter wake settings ✓
- Use the up / down keys to set the time ^ v

- Use the left / right keys to scroll between hours and minutes <>
- Press tick to confirm ✓
- Use the up / down keys to set the temperature ^ v
- Press tick to confirm the settings ✓
- Press the right arrow key >
- Leave will now be highlighted and the current settings will be displayed.
- Press tick to alter the leave settings ✓
- Repeat these steps to set all comfort levels.
- To blank or set a comfort level period to unused, first select the comfort level then press and hold the tick key for 5 seconds. 'Level unused' will appear in the corner of the display ✓
- When complete use the right key to scroll to done and press tick > ✓





Temperature control

The up / down keys allow you to adjust the current set temperature 

When you press either of these keys, you will see the set temperature and the desired temperature value.

Use the up / down keys to adjust the set value 

Press tick to confirm settings 



Set temperature

Note: This new temperature is maintained only until the next programmed comfort level. At this time, the thermostat will revert back to the programmed levels.



Temperature hold

The temperature hold function allows you to manually override the current operating program and set a different temperature for a desired period.

- Use the left / right keys to scroll to hold and press tick < > ✓
- Use the up / down keys to set the desired hold time ^ v
- Use the left / right keys to scroll between hours and minutes < >
- Press tick to confirm selection ✓
- Use the up / down keys to set the desired hold temperature ^ v
- Press tick to confirm selection ✓

You will see the 'Hold left' indication is displayed on screen.

The time will countdown the set duration and then revert to the normal program.







Hold left indicator and hold time remaining

To cancel a temperature hold, repeat these steps but reduce the hold time to 00:00 hrs



Locking therM₂

therM₂ has a keypad lock facility. To activate the lock follow these steps.

- Use the left / right keys to scroll to hold & press tick for 5 seconds ... 
- The display will show 0000 and you will need to enter a four digit pin number.
- Use the up / down keys to enter values 
- Use the left / right keys to move between digits 
- Press tick to confirm 

The display will return to the main screen and display the keypad lock indicator 



To enable keylock in time clock mode, select boost, press & hold tick for 5 seconds.

Note: The keypad lock indicator is only displayed when the lock is active.



Unlocking therM₂

To unlock therM₂ press tick once. The display will show **** and you will need to enter the four digit pin number you set previously.

- Use the up / down keys to enter values 
- Use the left / right keys to move between digits 
- Press tick to confirm 

The display will unlock and return to the main screen.



Standby / away mode

Use the left / right keys to scroll to the power icon < > ⏻

The frost protection symbol will toggle on / off each time tick is pressed ✓

In this mode, therM₂ will only turn the heating on should the room temperature drop below the set away temperature. This is configured in the setup menu.

If the heating is turned on whilst in standby / away mode, the flame symbol will be displayed. To cancel the standby / away mode, navigate to the power button and press tick ✓

Frost protection symbol



'Note: Away & standby modes both mean therM₂ is maintaining a lower temperature to give frost protection. Away is global meaning all zones on the system, standby is used for individual zones.'



Power on / off

The heating is indicated on when the flame icon is displayed.

When the flame icon is absent, there is no requirement for heating to achieve the set temperature but therM₂ remains active.

To turn therM₂ off completely, scroll to the power icon and hold the tick key for approximately 4 seconds until the display goes blank < > ✓

The display and heating output will be turned off.

To turn therM₂ back on, press the tick key once ✓

therM₂ completely off



therM₂ powered on





Holiday

In time clock mode; the timed output will be turned off during the holiday period, then return to the programmed settings once the holiday period finishes.
In thermostat mode; the holiday function reduces the set temperature in your home to the away mode temperature setting that is configured in the setup menu.

therM₂ will maintain this temperature for the duration of the holiday and will then automatically return to the program mode on your return.

- Use the left / right keys to scroll to holiday and press tick < > ✓
- Using the up / down keys enter the number of days holiday ^ v
- Press tick to confirm settings ✓

To cancel the holiday, repeat these steps but reduce the holiday duration to 00 days.

Note: A holiday period does not start until 00:00 the next day. For example, if you set a holiday period on Friday for 2 days, Saturday will be counted as the first day and the thermostat will revert back to the programmed schedule at 00:00 on Monday.



Optional features explained

THE FOLLOWING SETTINGS ARE OPTIONAL AND IN MOST CASES NEED NOT BE ADJUSTED.

Pairing with the app: This function is used to pair therM₂ to the therM2 app.

WiFi set-up: This function is used to connect therM₂ with the WiFi network.

Switching differential: This function allows you to increase the switching differential of the thermostat. The default is 0.5°C which means that with a set temperature of 20°C, the thermostat will switch the heating on at 19.5°C and off at 20.0°C. With a 1°C differential, the heating will switch on at 19.0°C and off at 20.0°C.

Away temperature: This is the temperature maintained when the thermostat is in away mode. The range is 7 - 17°C. The default is 12°C and is suitable for most applications.

Output delay: To prevent rapid switching, an output delay can be entered.

This can be set from 00 - 15 minutes. The default is 00 which means there is no delay.

Temperature up / down limit: This function allows you to limit the use of the up and down temperature arrow keys. This limit is also applicable when the thermostat is locked and so allows you to give others limited control over the heating system.

Sensor selection: On therM₂, you can select which sensor should be used. You can select between air temperature only, floor temperature, or both. When you enable both sensors, the floor sensor is used as a floor limiting sensor and is designed to prevent the floor from overheating.

Floor temp limit: This function is available when the floor sensor is enabled. You can set a floor limiting temperature between 20-45°C (27°C is the default setting).

Note: Air sensor only MUST NOT be used to control electric underfloor heating. Floor sensor or both should be used.

Optimum start: Optimum start will delay the start up of the heating system to the latest possible moment to avoid unnecessary heating and ensure the building is warm at the programmed time. therM₂ uses the rate of change information to calculate how long the heating needs to raise the building temperature 1°C (with a rate of change of 20, therM₂ has calculated the heating needs 20 minutes to raise the building temperature 1°C) and starts the heating accordingly.

Rate of change: Number of minutes for 1°C temperature rise.

Program mode: therM₂ offers three programming modes and the option of configuring it to work as a non-programmable thermostat.

Weekday / weekend - allows you to program 4 comfort levels for the weekday and 4 different comfort levels for the weekend.

7 day program mode - Each day has 4 comfort levels that can be programmed independently.

24 hour mode - All days are programmed the same and repeat continuously.

Temperature format: This function is used to select between °C and °F.

Ambient light dimming: When this function is enabled, the light sensor will detect when to dim the backlight when the ambient light levels drop. If you turn the room lights off, the backlight will dim so therM₂ does not light up the room.



Adjusting the optional settings

- Use the left / right keys to select setup
- Press tick to confirm selection



Features menu



Feature editing

- Use the up / down keys to scroll through features
- Use the left / right keys to change page
- Press tick to edit a feature
- Use the up / down keys to adjust the feature setting
- Press tick to confirm settings and return to the feature menu





Optional settings - Feature table

FEATURE	SETTING
Pairing with app	Used to pair with the therM2 App
WiFi setup	Used to connect to the WiFi network
Switching differential	0.5° - 3.0°C (0.5°C = default)
Away temperature	7° - 17°C (12°C = default)
Output delay	00 - 15 Minutes (00 = default)
Up/down temperature limit	00° - 10°C (00 = default)
Sensor selection	Built in sensor (default) Remote air sensor Floor sensor only Built in & floor sensor Remote air & floor sensor
Floor temperature limit	20°C - 45°C (27°C = default)
Optimum start	00-05 hours (00 = disabled as default)
Rate of change	Minutes to raise temperature by 1°C
Program mode	Weekday / weekend (default) 7 day programming 24 hour mode Non-programmable
Temperature format	00 = °C, 01 = °F (00 = default)
Ambient light dimming	On / Off



Re-calibrating therM₂

If you need to re-calibrate therM₂, follow these steps.

- Use the left / right keys to scroll to the power icon < >
- Press and hold tick to turn the display off ✓
- Press and hold the tick and down keys together for 4 seconds ✓
- The current temperature will appear on the display.
- Use the up / down keys to configure the new temperature value ^
- Press the tick key to confirm the change and the display will go blank ✓
- Press the tick key once to turn the thermostat on ✓



Error codes

therM₂ will display an error code if there is a fault with the temperature sensor, these error codes are explained below.

E0 = The internal sensor has developed a fault.

E1 = The remote floor probe has not been connected.

The remote floor probe has not been wired correctly.

The remote floor probe is faulty.

E2 = The remote air probe has not been connected.

The remote air probe has not been wired correctly.

The remote air probe is faulty.



Wiring diagram – Volt free output

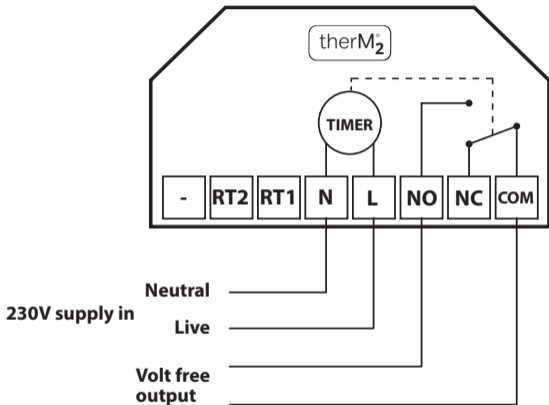

This product shall be installed by a competent person and comply with local installation regulations.



Wiring diagram – Switch live output

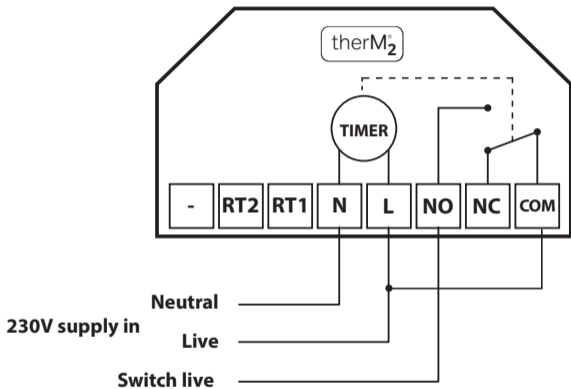

This product shall be installed by a competent person and comply with local installation regulations.

2 Mode 2 - Time clock



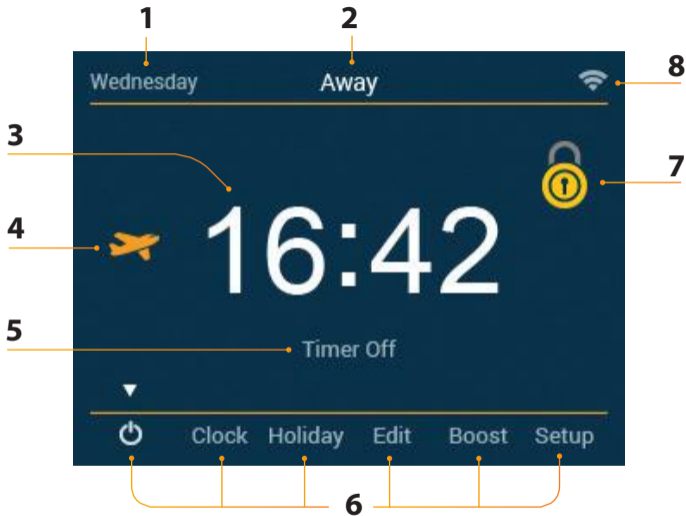

1. Day indicator - Displays the day of the week.
2. Away – Displayed when away mode is active.
3. Clock - Time displayed in 24 hour format.
4. Holiday – Displayed when the time clock is in holiday mode.
5. Timer status – Displays the current status of the timed output.
6. Main menu – Highlighted display indicates selected option.
7. Keypad lock indicator – Displayed when the keypad is locked.
8. WiFi indicator - Displayed when connected to a WiFi network.



Setting the switching times

To program the switching times, follow these steps

- Use the left / right keys to scroll to edit <>
- Press tick to confirm selection ✓
- Use the up / down keys to select the day / period to program ^v
- Press tick to confirm selection ✓
- 1 will now be highlighted and the on / off times will be displayed.
- Press tick to alter period 1 ✓
- To set the on time, use the up / down keys to set the hours, press the right arrow key & use up / down to set the minutes ... ^v>^v
- Press tick to confirm ✓
- To set the off time, use the up / down keys to set the hours, press the right arrow key & use up / down to set the minutes ... ^v>^v
- Press tick to confirm the settings ✓
- Press the right arrow key >
- 2 will now be highlighted and the current settings will be displayed.
- Press tick to alter period 2 settings ✓
- Repeat these steps to set all periods.
- To blank or set a switching level period to unused, first select the switching level then press and hold the tick key for 5 seconds.
- When all switching times have been programmed use the right arrow key to scroll to done and press tick > ✓



Timer boost

To boost the timed output to on follow these steps.

- Use the left / right keys to scroll to boost and press tick <> ✓
- Use the up / down keys to set the hours ^ v
- Press the right key to select minutes >
- Use the up / down keys to set the minutes ^ v
- Press tick to confirm settings and return to main display ✓

Boost left and the remaining time will now be displayed.

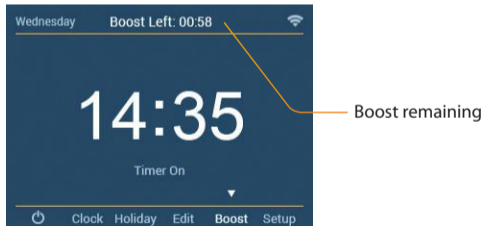

Note: In time clock mode pressing the up / down keys from the home screen will navigate directly to the boost screen.



Optional features explained

Pairing with the app: This function is used to pair therM₂ to the therM2 app.

WiFi set-up: This function is used to connect therM₂ with the WiFi network.

Program mode: The time clock offers three programming modes:

weekday / weekend (5/2), 7 day programming or 24 Hour.

Weekday / weekend - allows you to program 4 comfort levels for the weekday and 4 different comfort levels for the weekend.

7 day program mode - Each day has 4 comfort levels that can be programmed independently.

24 hour mode - All days are programmed the same and repeat continuously.

Ambient light dimming: When this function is enabled, the light sensor will detect when to dim the backlight when the ambient light levels drop. If you turn the room lights off, the backlight will dim so therM₂ does not light up the room.



Optional settings - Feature table

FEATURE

Pairing with the app

WiFi setup

Program mode

Ambient light dimming

SETTING

Used to pair to the therM2 app

Used to connect to the WiFi network

Weekday / weekend programming (default)

7 day programming

24 hour mode

On / Off



Wiring diagram - Time clock mode

(Mid position valve)

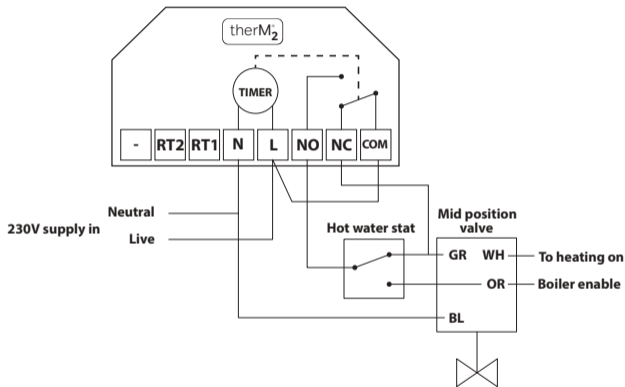

This product shall be installed by a competent person and comply with local installation regulations.



Wiring diagram - Time clock mode

(S plan)

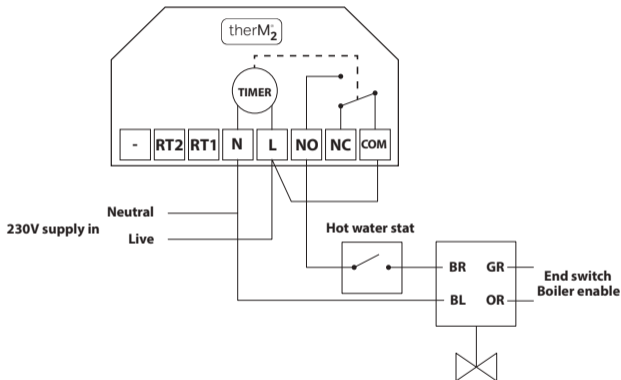

This product shall be installed by a competent person and comply with local installation regulations.



Replacing the battery

In most cases the 3 volt lithium battery does not need replacing if the thermostat has a continual power supply. Its sole purpose is to ensure correct time keeping during a power loss to the thermostat.

To remove the battery use a small flat head screw driver or fingertip to push back the brass retaining bracket. This will automatically release the battery.

Insert the new battery (**positive side up!**) by locating one end underneath the **holding clips** then pushing down on the opposite end against the brass holding bracket.



We advise that replacement of the lithium battery be carried out by a competent person.



Notes

A series of horizontal dotted lines for writing notes, spanning the width of the page.



Notes

A series of horizontal dashed lines for writing notes, spanning the width of the page.



Notes

A series of horizontal dashed lines for writing notes, spanning the width of the page.

therM[®]
CONTROLS



Want more information?

Call our support team on: 01566 778 424

Or view technical specifications directly on our website:
www.thermcontrols.com



PDF



FAQ