

© 2015 Architects Orange. This drawing is for preliminary purposes only. All columns and/or dimensions shown reflect preliminary locations. Final conditions to be field verified by tenant. Graphics illustrating proposed sign locations are for reference only. All tenant signage is subject to approval per the tenant sign criteria.

1. THIS DRAWING IS FOR PRELIMINARY PURPOSES ONLY. ALL COLUMNS AND/OR DIMENSIONS SHOWN REFLECT PRELIMINARY LOCATIONS. FINAL CONDITIONS TO BE FIELD VERIFIED BY TENANT.
2. GRAPHICS ILLUSTRATING PROPOSED SIGN LOCATIONS ARE FOR REFERENCE ONLY. ALL TENANT SIGNAGE IS SUBJECT TO APPROVAL PER THE TENANT SIGN CRITERIA.

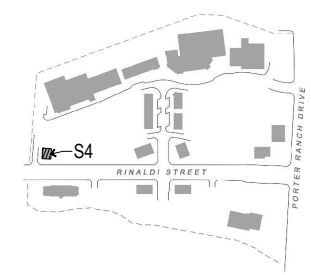

ELEVATION



KEY PLAN

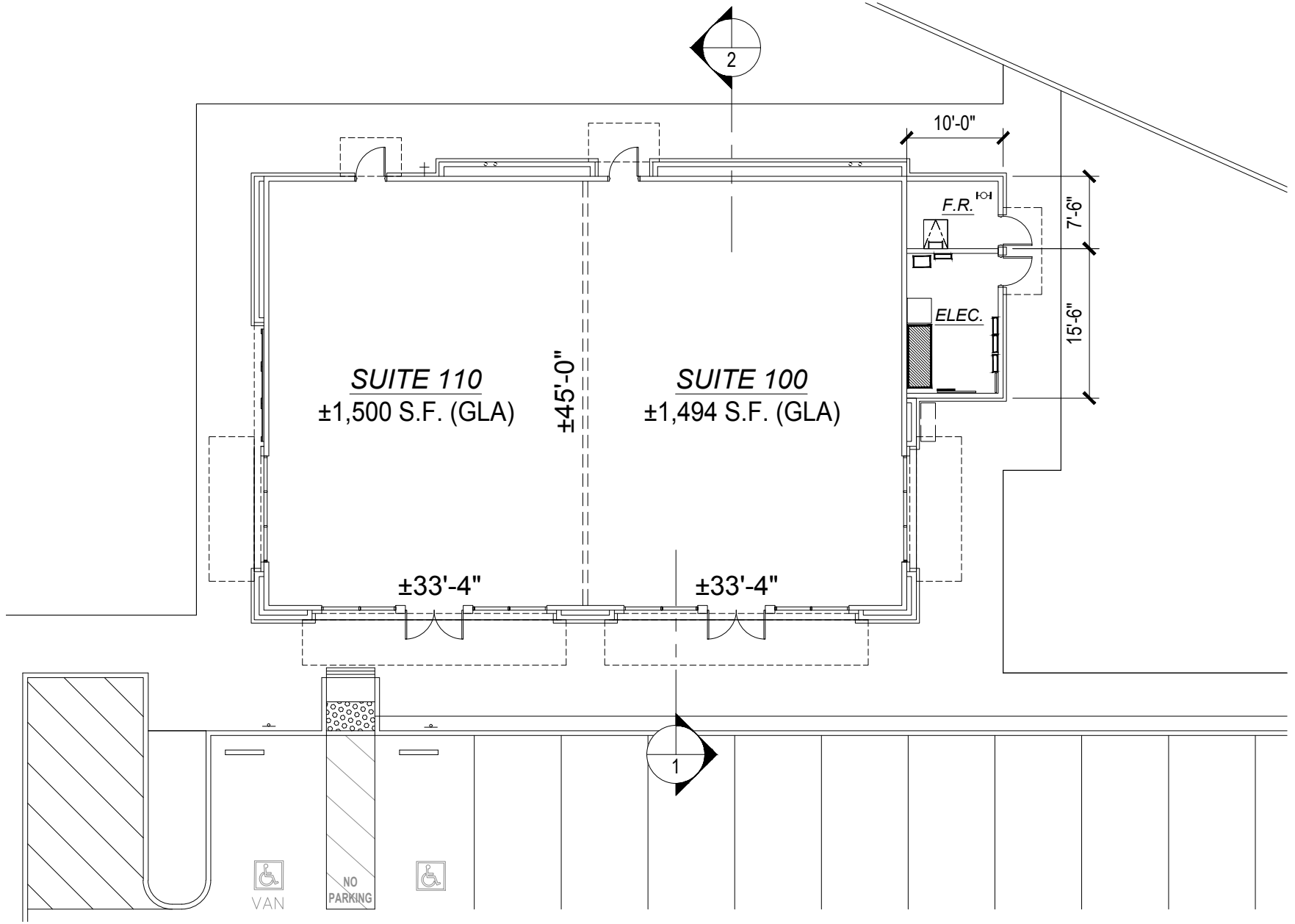

FLOOR PLAN

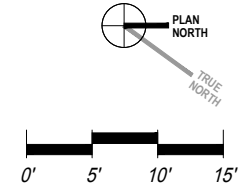

ARCHITECTS
ORANGE

100 South Orange Street • Orange, California 92668 • 714.938.8888



SHAPPELL
PROPERTIES

THE VINEYARDS AT PORTER RANCH
PORTER RANCH DRIVE AND RINALDI STREET
LOS ANGELES, CA 91326

20215 W. RINALDI ST.
(BLDG. S4)

Project Number: 2015-157 Date: 05-16-17
Plan Check Number:

REVISION	01-15-16
REVISION	02-22-16
REVISION	05-20-16
REVISION	05-16-17

SHEET
S4.1

1. THIS DRAWING IS FOR PRELIMINARY PURPOSES ONLY. ALL COLUMNS AND/OR DIMENSIONS SHOWN REFLECT PRELIMINARY LOCATIONS. FINAL CONDITIONS TO BE FIELD VERIFIED BY TENANT.
2. GRAPHICS ILLUSTRATING PROPOSED SIGN LOCATIONS ARE FOR REFERENCE ONLY. ALL TENANT SIGNAGE IS SUBJECT TO APPROVAL PER THE TENANT SIGN CRITERIA.

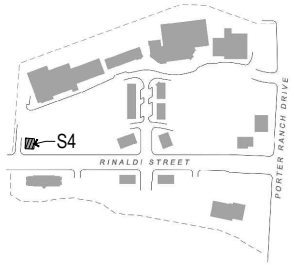
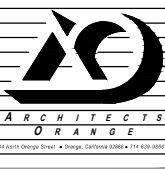

KEY PLAN



THE VINEYARDS AT PORTER RANCH
PORTER RANCH DRIVE AND RINALDI STREET
LOS ANGELES, CA 91326

20215 W. RINALDI ST.
(BLDG. S4)

Project Number: 2015-157 Date: 05-16-17

REVISION	DATE
1	12-21-16
2	05-16-17

SHEET
S4.2

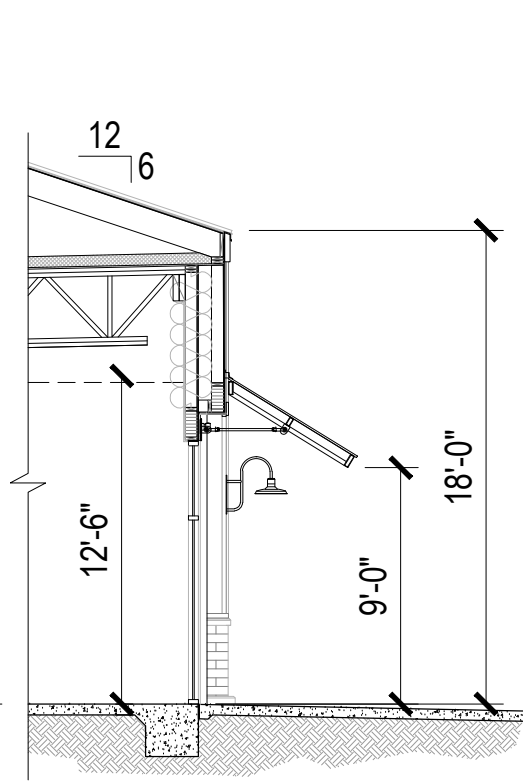

SECTION 1

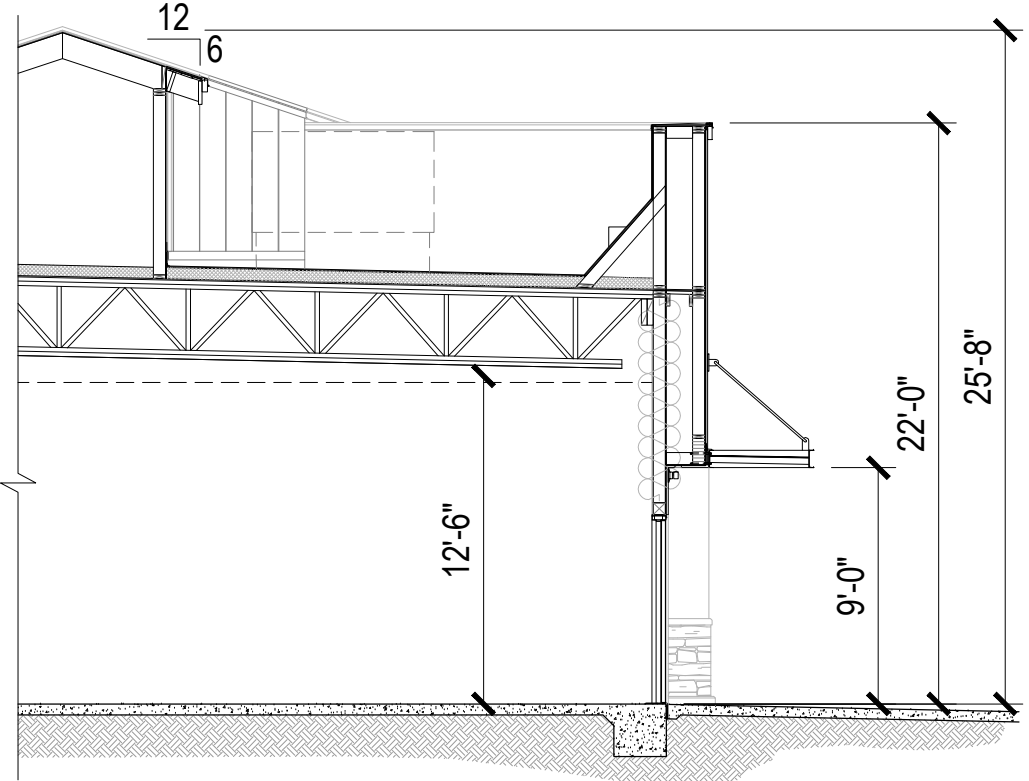

SECTION 2

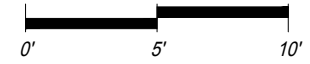

BUILDING SECTIONS