

No.	DATE	DESCRIPTION	REV	REMARK : RoHS REQUIREMENT APPLIED (符合RoHS)	DATE	DRAWING NO.
-----	------	-------------	-----	---	------	-------------

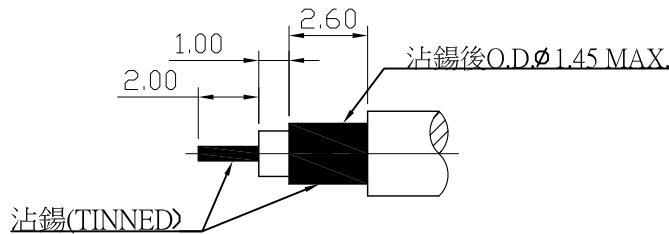

RECOMMENDED CABLE STRIPPING DIM'S
(建議剝線尺寸)

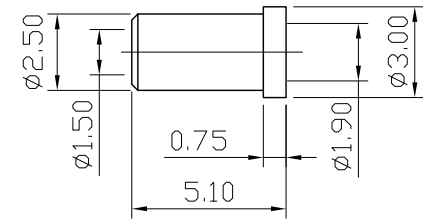
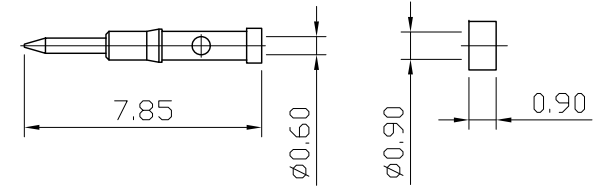
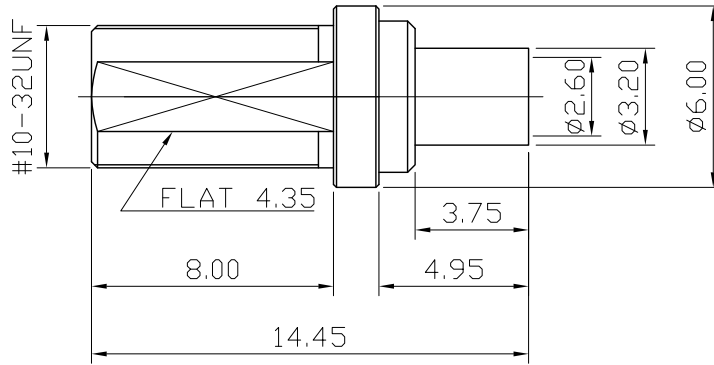
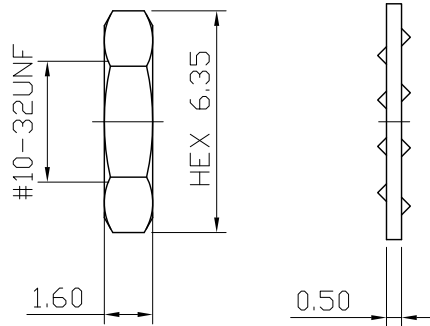
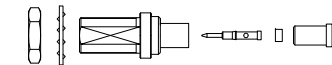

S 1 : 1

Electricals:

1. Impedance: 50 ohms
2. Frequency Range: DC~6.0 GHz
3. VSWR: 1.35 max.
4. Working Voltage : 335V rms
5. Dielectric Withstanding Voltage: 1000 MΩ min.

-	sleeve	1	brass	gold	DIMENSIONS ARE IN MILLIMETERS UNLESS OTHERWISE SPECIFIED TOLERANCES (一般公差) 0.5~6 = ±0.2 >6~30 = ±0.4 >30~120 = ±0.6 >120~315 = ±1 >315~1000 = ±1.6 ANGLES(角度) = ±5°	CHECKED	 雅鈦企業有限公司 Aec Connectors Co., Ltd.		
-	insulator	1	PTFE	none					
-	contact pin	1	brass	gold		DRAWN <i>Chad</i>		TITLE MCX STRAIGHT JACK REVERSE BULKHEAD CRIMP FOR RG178U,50 Ohm	
-	insulator	1	PTFE	white				DRAWING NO. MC-1005AGTG-SC1835	
-	body	1	brass	gold		DATE 2013. 12. 24		FILE NO. DRAWINGR\FM\CX\MC-1005AGTG-SC1835	
-	washer	1	brass	gold					
-	nut	1	brass	gold					
NO.	Description	Unit	Materials	Finish		Drawing No.		SCALE	4 : 1