

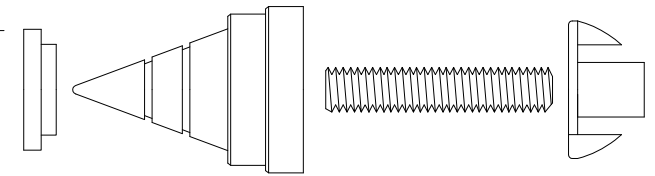

REMARK : RoHS REQUIREMENT APPLIED
(符合RoHS)

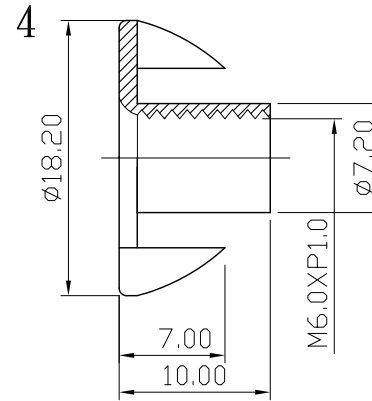
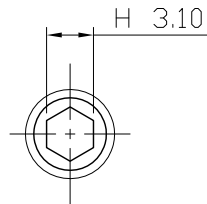
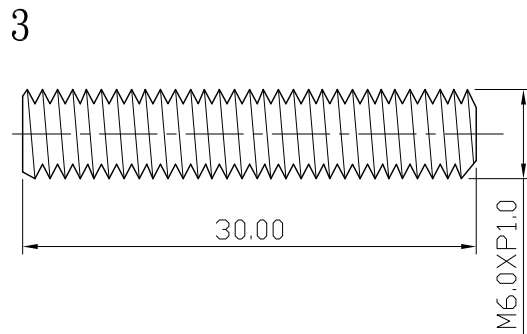
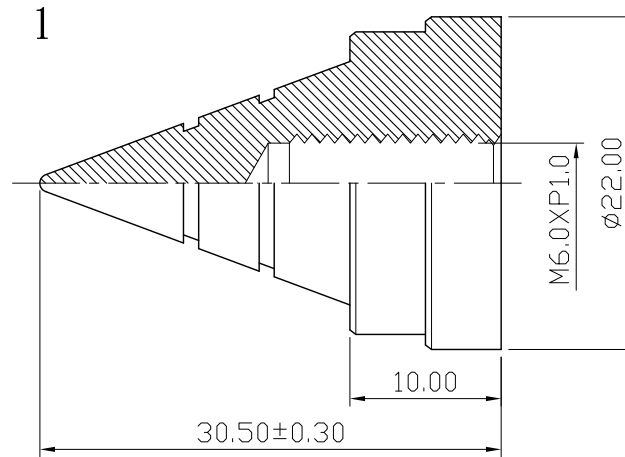
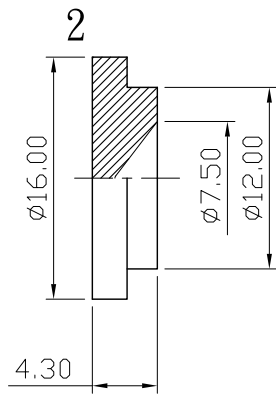

S 1 : 1

7						DIMENSIONS ARE IN MILLIMETERS UNLESS OTHERWISE PECIFIED TOLERANCES (一般公差) 0.5~6 = ±0.2 >6~30 = ±0.4 >30~120 = ±0.6 >120~315 = ±1 >315~1000 = ±1.6 ANGLES(角度) = ±5°	CHECKED DRAWN <i>Tina</i> DATE 2012. 04. 18	 雅鈦企業有限公司 Aec Connectors Co., Ltd.	
6					TITLE				SPIKE
5					DRAWING NO.				SPI-208G
4	headlock	1	iron	gold	FILE NO.				DRAWING\AUDIO\SPISPI-208G
3	screw	1	iron	gold					
2	plate	1	brass	gold					
1	spike	1	brass	gold					
NO.	Description	Unit	Materials	Finish	Drawing No.	SCALE	2 : 1	UNIT	MM